

Data sheet | Item number: 890-804

Socket for PCBs; straight; 4-pole; Cod. A; black

[www.wago.com/890-804](http://www.wago.com/890-804)

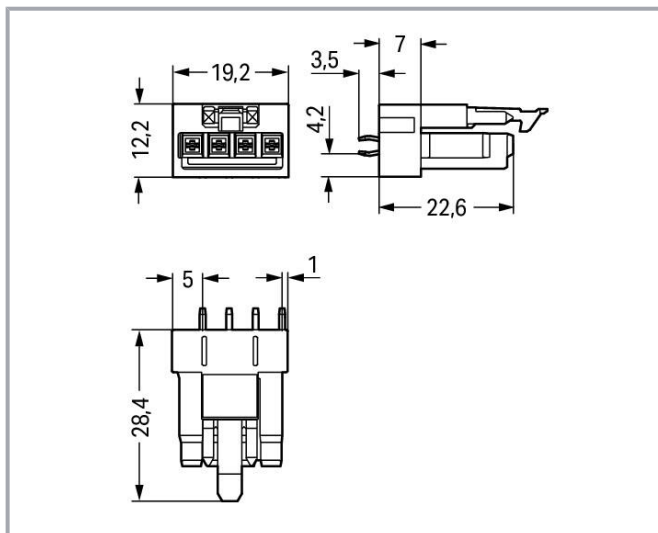

Subject to changes. Please also observe the further product documentation!

WAGO GmbH & Co. KG  
Hansastr. 27  
32423 Minden  
Phone: +49571 887-0 | Fax: +49571 887-169  
Email: [info.de@wago.com](mailto:info.de@wago.com) | Web: [www.wago.com](http://www.wago.com)

Do you have any questions about our products?  
We are always happy to take your call at +49 (571) 887-44222.

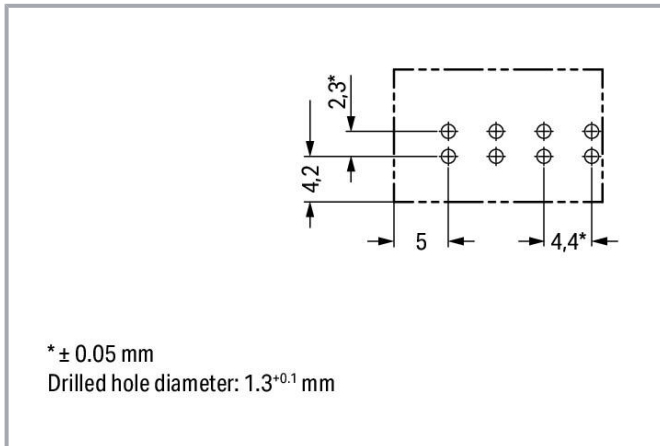

## Item description

### Female connector/socket WINSTA® MINI 4-pole

The WINSTA® MINI female connector/socket rated current 16 A are compact but high-quality PCB terminal blocks. They offer convenient operation and the greatest possible flexibility for installation. Our giant number of pluggable PCB connectors with different insertion directions and operating variants offers you the right solution for your application at any time. For greater security in electrical installations, the pcb connector is provided with mechanical protection against mismatching. The WINSTA® MINI pcb connector with A coding in black or white is usually used for general mains applications in power distribution. WINSTA® MINI follows the trend towards miniaturisation. Our smallest pluggable connection system is especially suitable for lights, for example, since due to LED technology, these offer much less space for the connection technology.

### Lower costs through fast commissioning and elimination of service expenses – solutions from WINSTA® MINI

The WINSTA® Pluggable Connection System is perfectly tailored to the very strict requirements of building installation. It makes electrical installation pluggable, and consequently faster, even more reliable, and error-free. Using this pre-assembled system decreases assembly times and errors during installation at the construction site. Now you can also reduce installation expenses without compromising safety and quality: The WINSTA® MINI pcb connector with locking lever eliminates the need for servicing and prevents unnecessary downtime.

- 
- pcb connector with protection against mismatching
- consistent IP40 protection
- with A coding for a great number of uses
- convenient installation and commissioning

Subject to changes. Please also observe the further product documentation!



## Data

### Electrical data

#### Ratings per IEC/EN

Ratings per	IEC/EN 60664-1
Nominal voltage (III/3)	250 V
Rated impulse voltage (III/3)	4 kV
Rated current	16 A
Legend (ratings)	(III / 3) ≙ Overvoltage category III / Pollution degree 3

#### Ratings per UL 1977

Note for the US market	Some versions may also be used for current interruption in accordance with the UL certificate in select applications with currents below 5 A and voltages up to 600 V. For further information, please contact your local sales office.
Rated voltage (UL 1977)	600 V
Rated current UL 1977	12 A

### General

Note on contact resistance	approx. 1 mΩ of contact resistance approx. 0.25 mΩ contact transition plug/socket
----------------------------	--

### Connection data

Total number of potentials	4
Number of levels	1

#### Connection 1

Pole number	4
-------------	---

### Physical data

Pin spacing	4.4 mm / 0.173 inches
Width	19.2 mm / 0.756 inches
Height	31.9 mm / 1.256 inches
Height from the surface	28.4 mm / 1.118 inches
Depth	12.2 mm / 0.48 inches

Subject to changes. Please also observe the further product documentation!

WAGO GmbH & Co. KG  
 Hansastr. 27  
 32423 Minden  
 Phone: +49571 887-0 | Fax: +49571 887-169  
 Email: [info.de@wago.com](mailto:info.de@wago.com) | Web: [www.wago.com](http://www.wago.com)

Do you have any questions about our products?  
 We are always happy to take your call at +49 (571) 887-44222.



Solder pin length	3.5 mm
Solder pin dimensions	1 x 0.8 mm
Drilled hole diameter with tolerance	1.3 <sup>(+0.1)</sup> mm

## Mechanical Data

Application	General mains applications
Coding	A
Variable coding	No
Marking	N $\frac{2}{L}$ 1/L'
Potential marking	N $\frac{2}{L}$ 1/L'
Mating force of a plug-in connection	approx. 20 ... 70 N (depending on pole number)
Retention force of a plug-in connection	Locked: > 80 N
Unmating force of a plug-in connection	Unlocked: approx. 20 ... 70 N (depending on pole number)
Number of mating cycles	200, without resistive load
Design	straight

## Plug-in connection

Contact type (pluggable connector)	Female connector/socket
Connector (connection type)	for PCB
Mismating protection	Yes
Note on mismating protection	All <i>WINSTA</i> <sup>®</sup> components are 100% protected against mismating when: a.) plugging different numbers of poles b.) plugging while rotated 180 c.) plugging while laterally staggered d.) plugging one pole
Mating direction to the PCB	90 °
Locking lever	yes
Locking of plug-in connection	locking lever
Note on locking system	All connectors for mounted installations (snap-in versions for lighting fixtures or devices, all types of PCB and distribution connectors) are factory-equipped with locking levers to ensure plugs and sockets are securely locked. Additional locking levers are only required for flying leads (plug/socket).

## PCB contact

PCB contact	THT
Solder pin arrangement	2 in-line solder pins/pole

Subject to changes. Please also observe the further product documentation!



Number of solder pins per potential	2
-------------------------------------	---

## Material Data

Note (material data)

Information on material specifications can be found here

Color	black
Cover color	gray
Material group	I
Insulation material	Polyamide (PA66)
Flammability class per UL94	V0
Clamping spring material	Chrome-nickel spring steel (CrNi)
Contact material	Copper or copper alloy; surface-treated
Contact plating	Tin
Fire load	0.074 MJ
Weight	4.4 g

## Environmental requirements

Processing temperature	-5 ... +40 °C
Continuous operating temperature	-35 ... +85 °C
Note on continuous operating temperature	Insulating parts for temperatures ≤ 105 °C

## Commercial data

Product Group	20 (Winsta)
eCl@ss 10.0	27-44-06-05
eCl@ss 9.0	27-44-06-05
ETIM 8.0	EC002560
ETIM 7.0	EC002560
PU (SPU)	50 pcs
Packaging type	box
Country of origin	PL
GTIN	4050821695479
Customs tariff number	85366990990



## Environmental Product Compliance

RoHS Compliance Status	Compliant, No Exemption
------------------------	-------------------------



Subject to changes. Please also observe the further product documentation!

## Approvals / Certificates



### General approvals

Logo	Approval	Additional Approval Text	Certificate name
	CCA DEKRA Certification B.V.	EN 61535	71-123231
	CCA DEKRA Certification B.V.	IEC 61535	NL-85020
	cURus Underwriters Laboratories Inc.	UL 1977	E45171

### Declarations of conformity and manufacturer's declarations

Logo	Approval	Additional Approval Text	Certificate name
	EU-Declaration of Conformity WAGO GmbH & Co. KG	-	-
	UK-Declaration of Conformity WAGO GmbH & Co. KG	-	-

### Approvals for marine applications

Logo	Approval	Additional Approval Text	Certificate name
	ABS American Bureau of Shipping	Steel Vessel Rules	19-HG1869855-PDA
	DNV GL Det Norske Veritas, Germanischer Lloyd	-	TAE00001Z6
	LR Lloyds Register	EN 61535	08/20047 (E2)

Subject to changes. Please also observe the further product documentation!

WAGO GmbH & Co. KG  
Hansastr. 27  
32423 Minden  
Phone: +49571 887-0 | Fax: +49571 887-169  
Email: [info.de@wago.com](mailto:info.de@wago.com) | Web: [www.wago.com](http://www.wago.com)

Do you have any questions about our products?  
We are always happy to take your call at +49 (571) 887-44222.

## Counterpart



**Item no.890-114**  
Plug; with strain relief housing; 4-pole; 1,50 mm<sup>2</sup>; black

[www.wago.com/890-114](http://www.wago.com/890-114)



**Item no.890-214**  
Plug; 4-pole; Cod. A; 1,50 mm<sup>2</sup>; black

[www.wago.com/890-214](http://www.wago.com/890-214)



**Item no.891-8994/006-101**  
pre-assembled interconnecting cable; Eca; Socket/plug; 4-pole; Cod. A; H05VV-F 4G 1.5 mm<sup>2</sup>; 1 m; 1,50 mm<sup>2</sup>; black

[www.wago.com/891-8994/006-101](http://www.wago.com/891-8994/006-101)



**Item no.891-8994/206-101**  
pre-assembled connecting cable; Eca; Plug/open-ended; 4-pole; Cod. A; H05VV-F 4G 1.5 mm<sup>2</sup>; 1 m; 1,50 mm<sup>2</sup>; black

[www.wago.com/891-8994/206-101](http://www.wago.com/891-8994/206-101)

## Downloads

### CAD/CAE-Data

#### CAD data

2D/3D Models 890-804	URL	Download

#### PCB Design

Symbol and Footprint 890-804	URL	Download

CAx data for your PCB design, consisting of "schematic symbols and PCB footprints", allow easy integration of the WAGO component into your development environment.

#### Supported formats:

- Accel EDA 14 & 15
- Altium 6 to current version
- Cadence Allegro
- DesignSpark
- Eagle Libraries
- KiCad
- Mentor Graphics BoardStation
- Mentor Graphics Design Architect
- Mentor Graphics Design Expedition 99 and 2000
- OrCAD 9.X PCB and Capture
- PADS PowerPCB 3, 3.5, 4.X, and 5.X
- PADS PowerPCB and PowerLogic 3.0
- PCAD 2000, 2001, 2002, 2004, and 2006

—  
Subject to changes. Please also observe the further product documentation!



- Pulsonix 8.5 or newer
- STL
- 3D STEP
- TARGET 3001!
- View Logic ViewDraw
- Quadcept
- Zuken CadStar 3 and 4
- Zuken CR-5000 and CR-8000

PCB Component Libraries (EDA), PCB CAD Library Ultra Librarian

---

#### CAE data

ZUKEN Portal 890-804	<a href="#">URL</a>	<a href="#">Download</a>
----------------------	---------------------	--------------------------

---

#### Environmental Product Compliance

##### Compliance Search

Environmental Product Compliance 890-804 Socket for PCBs; straight; 4-pole; Cod. A; black	<a href="#">URL</a>	<a href="#">Download</a>
--	---------------------	--------------------------

---

#### Installation Notes

#### Product family

**WINSTA® MINI**

[Show all products from the family](#)

Subject to changes. Please also observe the further product documentation!