



User Manual

ARK-2151V

**In-Vehicle Full HD NVR w/4 PoE
Ports**

ADVANTECH

Enabling an Intelligent Planet

Copyright

The documentation and the software included with this product are copyrighted 2015 by Advantech Co., Ltd. All rights are reserved. Advantech Co., Ltd. reserves the right to make improvements in the products described in this manual at any time without notice. No part of this manual may be reproduced, copied, translated or transmitted in any form or by any means without the prior written permission of Advantech Co., Ltd. Information provided in this manual is intended to be accurate and reliable. However, Advantech Co., Ltd. assumes no responsibility for its use, nor for any infringements of the rights of third parties, which may result from its use.

Acknowledgements

Intel® and Pentium® are trademarks of Intel Corporation.

Microsoft Windows® is a registered trademark of Microsoft Corp.

All other product names or trademarks are properties of their respective owners.

Product Warranty (2 years)

Advantech warrants to you, the original purchaser, that each of its products will be free from defects in materials and workmanship for two years from the date of purchase.

This warranty does not apply to any products which have been repaired or altered by persons other than repair personnel authorized by Advantech, or which have been subject to misuse, abuse, accident or improper installation. Advantech assumes no liability under the terms of this warranty as a consequence of such events.

Because of Advantech's high quality-control standards and rigorous testing, most of our customers never need to use our repair service. If an Advantech product is defective, it will be repaired or replaced at no charge during the warranty period. For out-of-warranty repairs, you will be billed according to the cost of replacement materials, service time and freight. Please consult your dealer for more details.

If you think you have a defective product, follow these steps:

1. Collect all the information about the problem encountered. (For example, CPU speed, Advantech products used, other hardware and software used, etc.) Note anything abnormal and list any onscreen messages you get when the problem occurs.
2. Call your dealer and describe the problem. Please have your manual, product, and any helpful information readily available.
3. If your product is diagnosed as defective, obtain an RMA (return merchandise authorization) number from your dealer. This allows us to process your return more quickly.
4. Carefully pack the defective product, a fully-completed Repair and Replacement Order Card and a photocopy proof of purchase date (such as your sales receipt) in a shippable container. A product returned without proof of the purchase date is not eligible for warranty service.
5. Write the RMA number visibly on the outside of the package and ship it prepaid to your dealer.

Declaration of Conformity

CE

This product has passed the CE test for environmental specifications. Test conditions for passing included the equipment being operated within an industrial enclosure. In order to protect the product from being damaged by ESD (Electrostatic Discharge) and EMI leakage, we strongly recommend the use of CE-compliant industrial enclosure products.

FCC Class A

Note: This equipment has been tested and found to comply with the limits for a Class A digital device, pursuant to part 15 of the FCC Rules. These limits are designed to provide reasonable protection against harmful interference when the equipment is operated in a commercial environment. This equipment generates, uses, and can radiate radio frequency energy and, if not installed and used in accordance with the instruction manual, may cause harmful interference to radio communications. Operation of this equipment in a residential area is likely to cause harmful interference in which case the user will be required to correct the interference at his own expense.

Technical Support and Assistance

1. Visit the Advantech web site at www.advantech.com/support where you can find the latest information about the product.
2. Contact your distributor, sales representative, or Advantech's customer service center for technical support if you need additional assistance. Please have the following information ready before you call:
 - Product name and serial number
 - Description of your peripheral attachments
 - Description of your software (operating system, version, application software, etc.)
 - A complete description of the problem
 - The exact wording of any error messages

Warnings, Cautions and Notes

Warning! *Warnings indicate conditions, which if not observed, can cause personal injury!*



Caution! *Cautions are included to help you avoid damaging hardware or losing data.*



Note! Notes provide optional additional information.



Document Feedback

To assist us in making improvements to this manual, we would welcome comments and constructive criticism. Please send all such - in writing to: support@advan-tech.com

Packing List

Before setting up the system, check that the items listed below are included and in good condition. If any item does not accord with the table, please contact your dealer immediately.

- 1 x ARK-2151V unit
- 1 x Hard copy user manual (Simplified Chinese)
- 1 x 3 pin phoenix power block 3.81mm
- 1 x GPS ANT active w/ 5M SMA cable
- 1 x 10 pin DIO plug block

Ordering Information

P/N	Description
ARK-2151V-S6A1E	Intel Celeron 2980U DC 1.6 GHz w/4 COM
ARK-2151V-S9A1E	Intel Core i5 4300U DC 1.9 GHz w/4 POE

Safety Instructions

1. Read these safety instructions carefully.
2. Keep this User Manual for later reference.
3. Disconnect this equipment from any AC outlet before cleaning. Use a damp cloth. Do not use liquid or spray detergents for cleaning.
4. For plug-in equipment, the power outlet socket must be located near the equipment and must be easily accessible.
5. Keep this equipment away from humidity.
6. Put this equipment on a reliable surface during installation. Dropping it or letting it fall may cause damage.
7. Do not leave this equipment in an environment unconditioned where the storage temperature under -40°C or above 80°C , it may damage the equipment. Operating temperature is -20°C to 60°C .
8. The openings on the enclosure are for air convection. Protect the equipment from overheating. **DO NOT COVER THE OPENINGS.**
9. Make sure the voltage of the power source is correct before connecting the equipment to the power outlet. Cable of Power source should be shielded.
10. Position the power cord so that people cannot step on it. Do not place anything over the power cord. The voltage and current rating of the cord should be greater than the voltage and current rating marked on the product.
11. All cautions and warnings on the equipment should be noted.
12. If the equipment is not used for a long time, disconnect it from the power source to avoid damage by transient overvoltage.
13. Never pour any liquid into an opening. This may cause fire or electrical shock.
14. Never open the equipment. For safety reasons, the equipment should be opened only by qualified service personnel.
15. If one of the following situations arises, get the equipment checked by service personnel:
 - The power cord or plug is damaged.
 - Liquid has penetrated into the equipment.
 - The equipment has been exposed to moisture.
 - The equipment does not work well, or you cannot get it to work according to the user's manual.
 - The equipment has been dropped and damaged.
 - The equipment has obvious signs of breakage.
16. **CAUTION:** The computer is provided with a battery-powered real-time clock circuit. There is a danger of explosion if battery is incorrectly replaced. Replace only with same or equivalent type recommended by the manufacture. Discard used batteries according to the manufacturers instructions.
17. **ATTENTION:** L'ordinateur est muni d'un circuit en temps réel de l'horloge alimentée par batterie. Il ya un danger d'explosion si la pile est remplacée de façon incorrecte. Remplacez uniquement par un type identique ou équivalent recommandé par le fabricant. Jetez les piles usagées selon les instructions du fabricant.

-
18. CAUTION: Always completely disconnect the power cord from your chassis whenever you work with the hardware. Do not make connections while the power is on. Sensitive electronic components can be damaged by sudden power surges.
 19. CAUTION: Always ground yourself to remove any static charge before touching the motherboard, backplane, or add-on cards. Modern electronic devices are very sensitive to static electric charges. As a safety precaution, use a grounding wrist strap at all times. Place all electronic components on a static-dissipative surface or in a static-shielded bag when they are not in the chassis.
 20. CAUTION: Any unverified component could cause unexpected damage. To ensure the correct installation, please always use the components (ex. screws) provided with the accessory box.
 21. ATTENTION: Tout composant non vérifiée pourrait causer des dommages inattendu. Pour garantir une installation correcte, s'il vous plaît utilisez toujours les composants(vis ex.) fournies avec la boîte d'accessories.

Contents

Chapter 1	General Introduction	1
1.1	Introduction	2
1.2	Features	3
1.3	Specifications	3
	Table 1.1: Power Input / Output Support Information	4
1.4	Dimensions	5
	Figure 1.1 ARK-2151V dimensions	5
Chapter 2	Hardware installation	7
2.1	Overview of Hardware Installation & Upgrading	8
2.2	Installing Memory	8
2.3	Installing storage	9
	2.3.1 Installing 2.5" SSD or HDD	9
	2.3.2 Installing mSATA Storage	9
2.4	Installing Optional Modules	10
	2.4.1 Installing WLAN module	10
	2.4.2 Installing WWAN module	11
Chapter 3	Jumper and Switch Settings	13
3.1	Setting Jumpers and Switches	14
	3.1.1 Main Board	15
	Figure 3.1 Top side of main board	15
	Figure 3.2 Bottom side of main board	15
	3.1.2 I/O Board (ARK-2151V-S6A1E Only)	16
	Figure 3.3 Top side of I/O board	16
	Figure 3.4 Bottom side of I/O board	16
	3.1.3 I/O board (ARK-2151V-S9A1E Only)	17
	Figure 3.5 Bottom side of I/O board	17
	3.1.4 Power Board	17
	Figure 3.6 Top side of power board	17
3.2	Jumper Lists	18
	3.2.1 Main Board	18
	3.2.2 I/O Board (ARK-2151V-S6A1E Only)	18
	3.2.3 I/O Board (ARK-2151V-S9A1E Only)	18
	3.2.4 Power Board	18
3.3	Jumper Settings	19
	3.3.1 Main Board	19
	Table 3.1: Auto Power On Setting (J2)	19
	Table 3.2: LCD Power (J3)	19
	Table 3.3: mPCIe & mSATA Selection (SW2)	19
	Table 3.4: Clear CMOS (SW3)	20
	3.3.2 I/O Board (ARK-2151V-S6A1E Only)	20
	Table 3.5: RS232/422/485 Setting	20
	Table 3.6: RS232/422/485 Setting	20
	Table 3.7: WWAN Voice Audio -PCM Data In/Out Swap	21
	Table 3.8: WWAN Module Power Selection	21
	3.3.3 I/O Board (ARK-2151V-S9A1E Only)	22
	Table 3.9: 3G Voice Audio -PCM Data In/Out Swap	22
	Table 3.10: 3G/4G Module Power Selection	22
	3.3.4 Power Board	23
	Table 3.11: Power Ignition HW Setting	23

Chapter 4 Pin Assignments 25

4.1	ARK-2151V-S6A1E I/O Connectors	26
4.1.1	ARK-2151V-S6A1E Front I/O View	26
4.1.2	ARK-2151V-S6A1E Rear I/O View	26
4.2	ARK-2151V-S6A1E I/O Pin Definition.....	26
4.2.1	VGA Connector.....	26
	Figure 4.1 VGA Connector	26
	Table 4.1: VGA Connector Pin Assignments	26
4.2.2	USB Connector.....	27
	Figure 4.2 USB Connector [Upper (black): USB2.0 / Down (blue): USB 3.0].....	27
	Table 4.2: USB Connector Pin Assignments.....	27
4.2.3	Ethernet Connector.....	27
	Figure 4.3 Ethernet Connector	27
	Table 4.3: Ethernet Connector Pin Assignments	27
4.2.4	HDMI Connector.....	28
	Figure 4.4 HDMI Connector.....	28
	Table 4.4: HDMI / Display Port Connector Pin Assignments	28
4.2.5	DIO Connector.....	28
	Figure 4.5 DIO Connector	28
4.2.6	Power Input Connector.....	29
	Figure 4.6 Power Input Connector.....	29
4.2.7	COM Connector.....	29
	Figure 4.7 COM Port Connector	29
	Table 4.5: COM Connector Pin Assignments.....	29
4.2.8	System Audio Connector.....	30
	Figure 4.8 System Audio Connector.....	30
	Table 4.6: Audio Connector Pin Assignments.....	30
4.2.9	Cellular Voice Connector.....	30
	Figure 4.9 Cellular Voice Connector.....	30
	Table 4.7: Cellular Voice Connector Pin Assignments.....	30
4.2.10	Optional I/O.....	30
4.2.11	Power Input Mode.....	31
	Figure 4.10 Power Input Mode	31
4.2.12	Power On/Off Button.....	31
	Figure 4.11 Power ON/OFF Button	31
4.2.13	Reset	31
	Figure 4.12 Reset	31
4.2.14	LED Indicator	31
	Figure 4.13 LED Indicator.....	31
4.3	ARK-2151V-S9A1E I/O Connectors	32
4.3.1	ARK-2151V-S9A1E Front I/O View	32
4.3.2	ARK-2151V-S9A1E Rear I/O View	32
4.4	ARK-2151V-S9A1E I/O Pin Definition.....	32
4.4.1	VGA Connector.....	32
	Figure 4.14 VGA Connector	32
	Table 4.8: VGA Connector Pin Assignments	32
4.4.2	USB Connector.....	33
	Figure 4.15 USB Connector [Upper (black): USB2.0 / Down (blue): USB 3.0].....	33
	Table 4.9: USB Connector Pin Assignments.....	33
4.4.3	Ethernet Connector.....	33
	Figure 4.16 Ethernet Connector	33
	Table 4.10: Ethernet Connector Pin Assignments	33
4.4.4	HDMI Connector	34
	Figure 4.17 HDMI Connector.....	34

	Table 4.11: HDMI / Display Port Connector Pin Assignments.....	34
4.4.5	DIO Connector.....	34
	Figure 4.18 DIO Connector.....	34
4.4.6	Power Input Connector.....	35
	Figure 4.19 Power Input Connector.....	35
4.4.7	Power Over Ethernet.....	35
	Figure 4.20 Power Over Ethernet Connector.....	35
	Table 4.12: Power Over Ethernet (PoE) Pin Definition.....	35
4.4.8	System Audio Connector.....	35
	Figure 4.21 System Audio Connector.....	35
	Table 4.13: Audio Connector Pin Assignments.....	36
4.4.9	Cellular Voice Connector.....	36
	Figure 4.22 Cellular Voice Connector.....	36
	Table 4.14: Cellular Voice Connector Pin Assignments.....	36
4.4.10	Optional I/O.....	36
4.4.11	Power Input Mode.....	36
	Figure 4.23 Power Input Mode.....	36
4.4.12	Power On/Off Button.....	37
	Figure 4.24 Power ON/OFF Button.....	37
4.4.13	Reset.....	37
	Figure 4.25 Reset.....	37
4.4.14	LED Indicator.....	37
	Figure 4.26 LED Indicator.....	37

Chapter 5 BIOS settings39

5.1	Introduction.....	40
	Figure 5.1 Setup program initial screen.....	40
5.2	Entering Setup.....	41
5.2.1	Main Setup.....	41
	Figure 5.2 Main setup screen.....	41
5.2.2	Advanced BIOS Features Setup.....	42
	Figure 5.3 Advanced BIOS features setup screen.....	42
	Figure 5.4 PCI Subsystem Settings.....	43
	Figure 5.5 PCI Express Device Register Settings.....	44
	Figure 5.6 ACPI Setting.....	45
	Figure 5.7 Trusted Computing Configuration.....	46
	Figure 5.8 S5 RTC Wake Settings.....	47
	Figure 5.9 CPU Configuration Setting.....	48
	Figure 5.10 SATA Configuration.....	49
	Figure 5.11 Intel® Rapid Technology.....	50
	Figure 5.12 AMT Configuration.....	51
	Figure 5.13 PCH-FW Configuration.....	52
	Figure 5.14 USB Configuration.....	53
	Figure 5.15 Embedded Controller Configuration.....	54
	Figure 5.16 Super IO Configuration.....	55
	Figure 5.17 Serial Port Console Redirection.....	56
5.2.3	Chipset.....	57
	Figure 5.18 Chipset Setup.....	57
	Figure 5.19 System Agent (SA) Configuration.....	58
	Figure 5.20 Intel IGFX Configuration.....	59
	Figure 5.21 LCD Control.....	60
	Figure 5.22 Memory Configuration.....	61
	Figure 5.23 PCH-IO Configuration.....	62
	Figure 5.24 PCI Express Configuration.....	63
	Figure 5.25 USB Configuration.....	64
	Figure 5.26 PCH Azalia Configuration.....	65
5.2.4	Boot Settings.....	66
	Figure 5.27 Boot Setup Utility.....	66

5.2.5	Security Setup	67
	Figure 5.28 Password Configuration	67
5.2.6	Save & Exit	68
	Figure 5.29 Save & Exit	68

Appendix A **WDT Sample Code** **71**

A.1	Watchdog Timer Sample Code	72
-----	----------------------------------	----

Chapter 1

General Introduction

This chapter gives background information on ARK-2151V series.

1.1 Introduction

ARK-2151V is an industrial grade dual core mobile device for in vehicle computer and in vehicle NVR solution.

ARK-2151V support Full-HD NVR solutions and is fully integrated certified hardware and intelligent management software design. ARK-2151V integrated in-vehicle power (ISO-7637-2), in-vehicle certifications (E-Mark, IEC-60721-3-5 5M3) and well-developed vehicle software SDK and APIs for in-vehicle applications. They also provided extension capability and wireless communication (GPS/G-sensor/Wi-Fi/3G/CANBus) for excellent connectivity, high graphic power (Up to 1080p @120fps) for video preview, and integrated software for manageability and security.

ARK-2151V-S6A1E I/O Overview

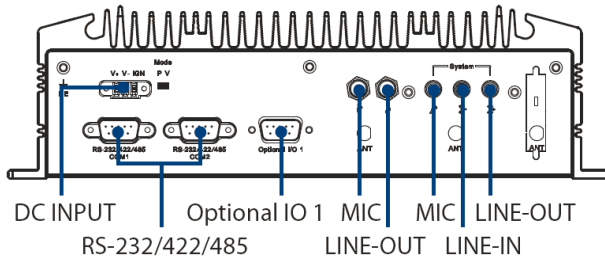
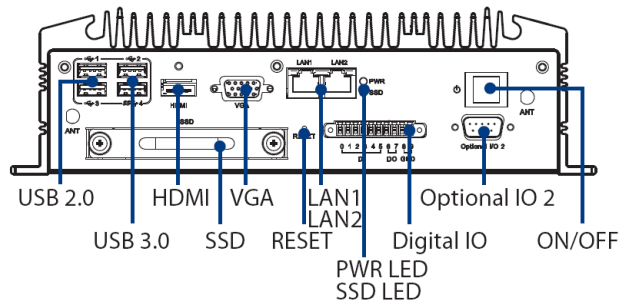

ARK-2151V-S9A1E I/O Overview

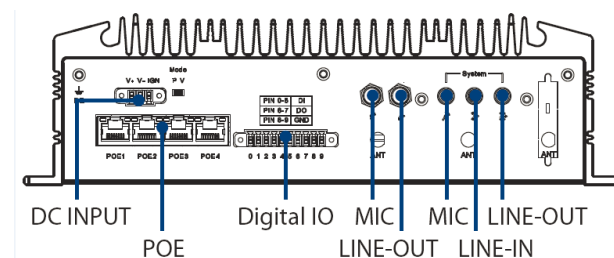
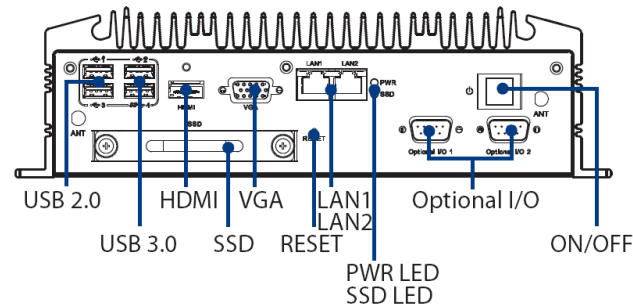

1.2 Features

- Intel® Celeron 2980U 1.6 GHz / Core i5-4300U 1.9 GHz SoC
- 4 PoE Ports to Support Mainstream IP Cameras
- Diversity Communication Abilities, ex. WWAN, WLAN
- Built-in GPS and G-Sensor for GIS application
- Intelligent Vehicle Power Ignition
- 9 ~ 36 Vdc* Wide Power Input w/isolation
(*: Power input constraint at low power 9 ~ 10.9 V.)
- Dual storage: 1 x removable 2.5" drive bay & 1 x F/S mSATA
- Supports iManager, SUSIAccess and Embedded Software APIs

1.3 Specifications

- **CPU:**
 - ARK-2151V-S6A1E: Intel Celeron 2980U DC 1.6 GHz
 - ARK-2151V-S9A1E: Intel Core i5 4300U DC 1.9 GHz
- **Chipset:**
 - ARK-2151V-S6A1E: HD graphics
 - ARK-2151V-S9A1E: GT2-4400 graphics
- **BIOS:** AMI EFI 128 Mbit
- **System memory:**
 - ARK-2151V-S6A1E: 1 x 204pin SODIMM, DDR3L 1333 MHz, up to 8 GB
 - ARK-2151V-S9A1E: 1 x 204pin SODIMM, DDR3L 1600 MHz, up to 8 GB
- **Storage:**
 - 2.5" drive bay: 1 x removable 2.5" drive bay (Max 9.5 mm height)
 - mSATA: 1x full size mSATA storage
- **Serial ports:**
 - ARK-2151V-S6A1E: 2 x RS-232/422/485 ports w/ 3 KV isolation (support auto flow control, jumper selectable)
- **Optional I/O:**
 - ARK-2151V-S6A1E: 2 x CANBus 2.0 A/B or 2 x RS-232/422/485
 - ARK-2151V-S9A1E: 2 x CANBus 2.0 A/B or 2 x RS-232/422/485
- **Universal serial bus (USB) port:** 2 x USB 2.0 & 2 x USB3.0
- **LAN port:** 2 x Giga LAN 10/100/1000 Mbps, support wake on LAN
- **Power over Ethernet, POE (ARK-2151V-S9A1E only):** Support 4 x 10/100 Mbps
 - 4ports full-load, IEEE802.3af Class 2 (7 Watt)
 - 2ports full-load, IEEE802.3af Class 3 (15.4 Watt)
- **LED:** Power LED, SSD LED
- **Graphic output:**
 - 1 x VGA, up to 1920 x 1200 with 60 Hz, 154 MHz pixel clock rate
 - 1 x lockable HDMI connector, up to 4K at 24 Hz
- **Mini PCI express bus expansion slot:**
 - 1 x full size mini PCIe slot, support mSATA storage
 - 1 x half size mini PCIe slot, support WLAN module
 - 2 x full size mini PCIe slots w/SIM holder, support WWAN module (USB interface)
- **Watchdog timer:** 255-level timer interval, setup by software

- **RTC Battery:** 3.0 V @ 200 mAH lithium battery.
- **Digital I/O:** 6 x DI & 2 x DO w/ 3KV isolation
 - Input Voltage: 0 to 30 VDC at 25 Hz,
 - Output Current: Max. 500 mA per channel
 - On-state Voltage: 24 VDC nominal, open collector to 30 VDC
- **Audio:**
 - Main system: Realtek ALC888S, High Definition Audio (HD), Line-in, Line out, Mic-in
 - Cellular Voice*: Support WWAN voice function, Line-out, Mic-in
(*: Enable cellular voice function should set up AT command which follow module design.)
- **GPS:** On board standalone GPS, support GPS, GLONASS and QZSS signals
- **G-sensor:** On board high resolution G-Sensor, up to 13-bit resolution at ±16g
- **Power Requirement:**
 - Power type: ATX/AT
 - Input voltage:
Support: 9 ~ 36 VDC*

Table 1.1: Power Input / Output Support Information

	Output: 12V (for M/B)	Output: 48 V (for PoE)
Input 11 V ~ 36 V	5 A	0.75 A
Input 10.0 V ~ 10.9 V	4 A	0.5 A
Input 9.0 ~ 9.9 V	3.5 A	N/A

- Vehicle Power Ignition: Selectable boot-up & shut-down voltage, on/off delay time
- Isolation: 1.5 KV Isolated
- **Dimensions: (W x H x D):** 264.5 x 75.1 x 133.0 mm (10.41" x 2.96" x 5.24")
- **Enclosure:** Ruggedized aluminum housing.
- **Operating temperature:**
 - With extended temperature peripherals:-20 ~ 60° C with 0.7m/s air flow
 - With standard temperature peripherals:0 ~ 45° C with 0.7m/s air flow
- **Storage temperature:** -40 ~ 85° C (-40 ~ 185° F)
- **Relative humidity:** 95% @ 40° C (non-condensing)
- **Vibration / Shock:** With mSATA/SSD: IEC 60721-3-5 Class 5M3
- **Certifications:**
 - EMC: CE/FCC Class A, CCC, BSMI
 - Safety: UL, CCC, BSMI, E-Mark (E13)
 - In-Vehicle Power: ISO7637-2 Lev.4

1.4 Dimensions

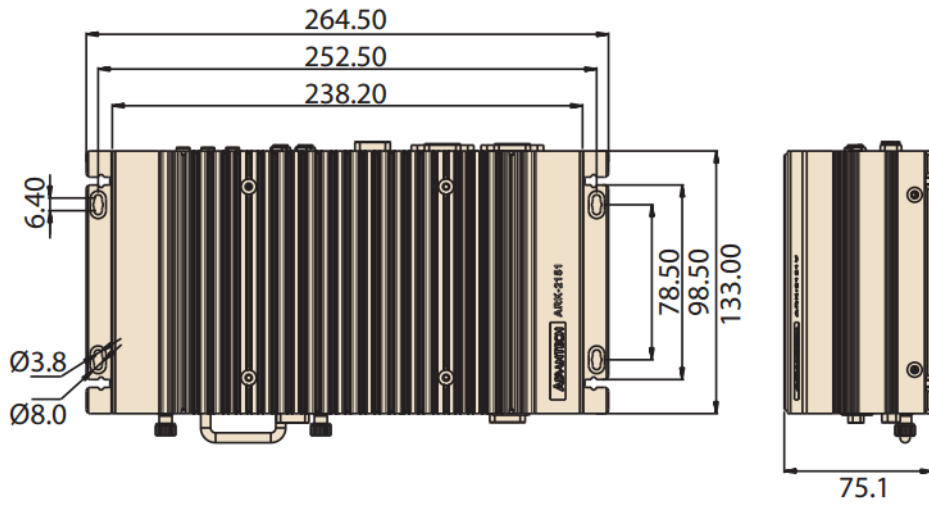

Figure 1.1 ARK-2151V dimensions

Chapter 2

Hardware installation

This chapter introduces the installation of ARK-2151V Hardware.

2.1 Overview of Hardware Installation & Upgrading

Warning! Do not remove the ruggedized aluminum covers until verifying that no power is flowing within the computer. Power must be switched off and the power cord must be unplugged. Take care in order to avoid injury or damage to the equipment.



2.2 Installing Memory

Need to remove total 9pcs screws and can install memory on the top side of board. (4pcs on top and 5pcs on side of top cover)

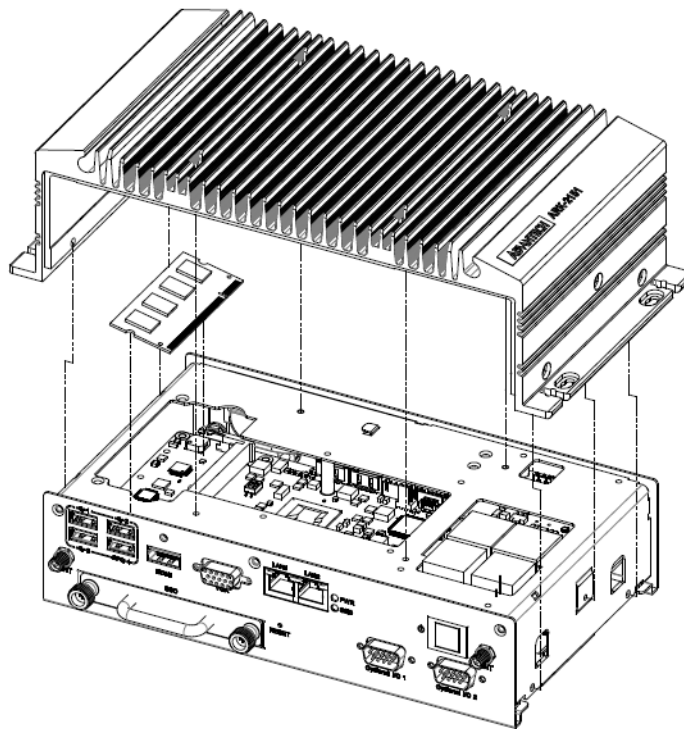

2.3 Installing storage

2.3.1 Installing 2.5" SSD or HDD

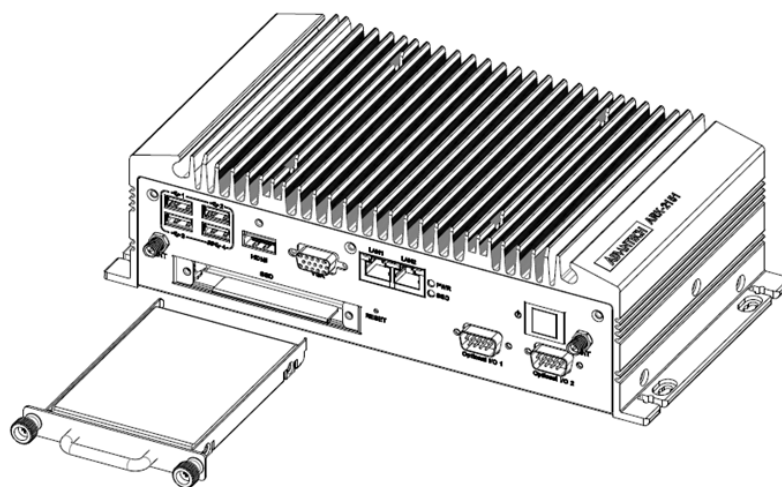

2.3.2 Installing mSATA Storage

1. Remove 6pcs screws on bottom cover.

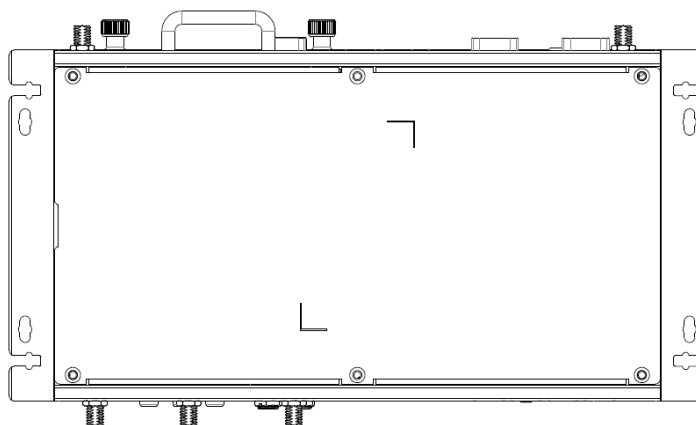

2. Remove 2.5" drive bay and Insert full size mSATA storage in marked place.

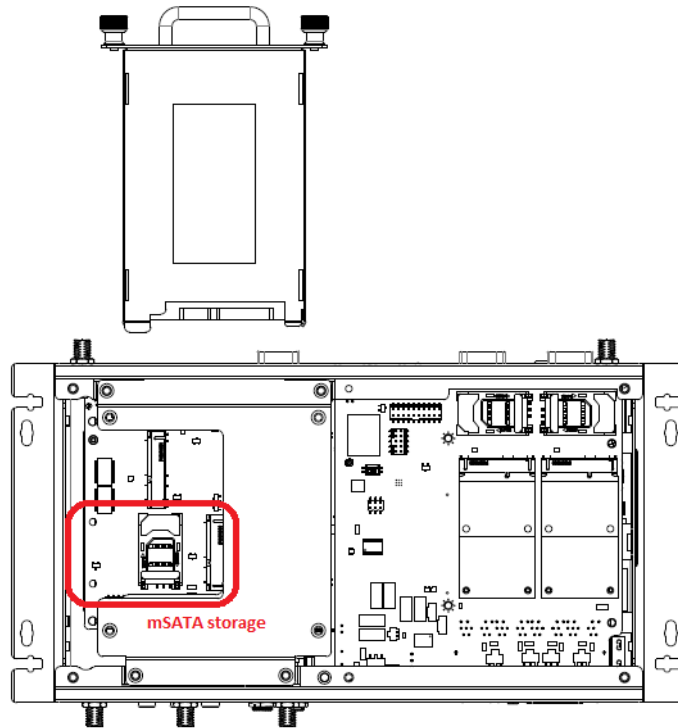

2.4 Installing Optional Modules

2.4.1 Installing WLAN module

1. Remove 6pcs screws on bottom cover.

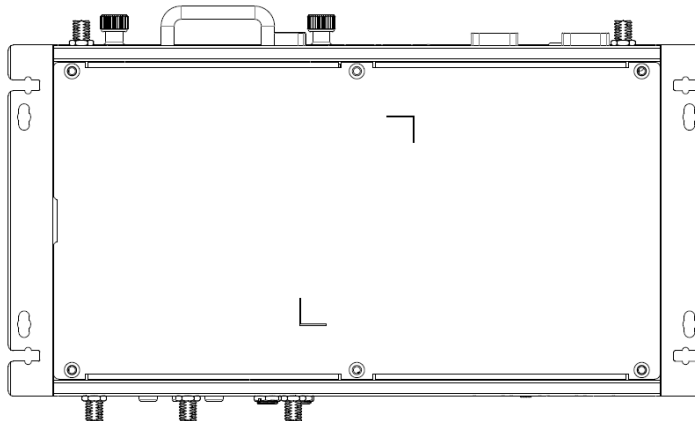

2. Remove 2.5" drive bay and Insert half size WLAN module in marked place.

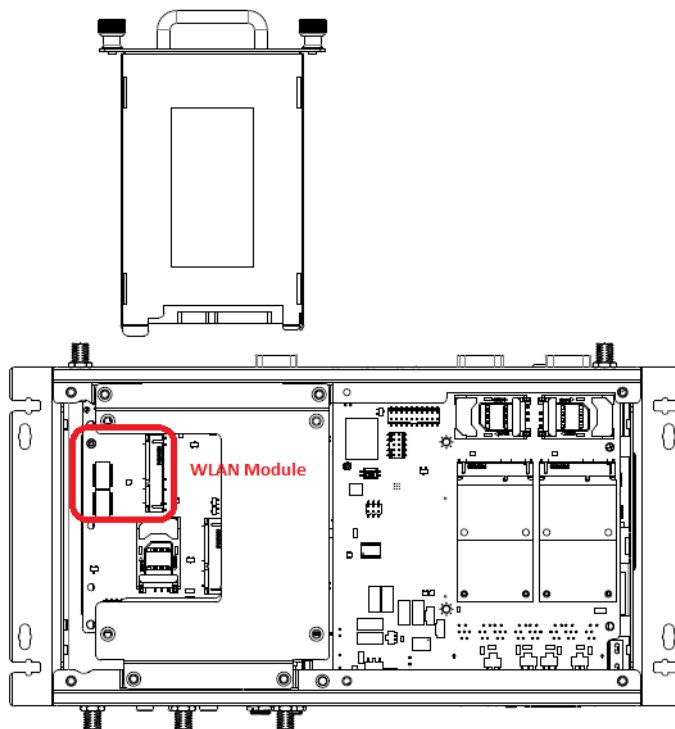

2.4.2 Installing WWAN module

1. Remove 6pcs screws on bottom cover.

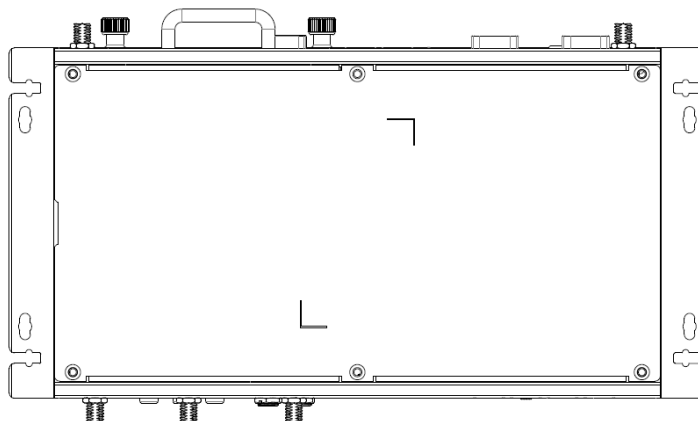

2. Insert full size WWAN module in marked place.

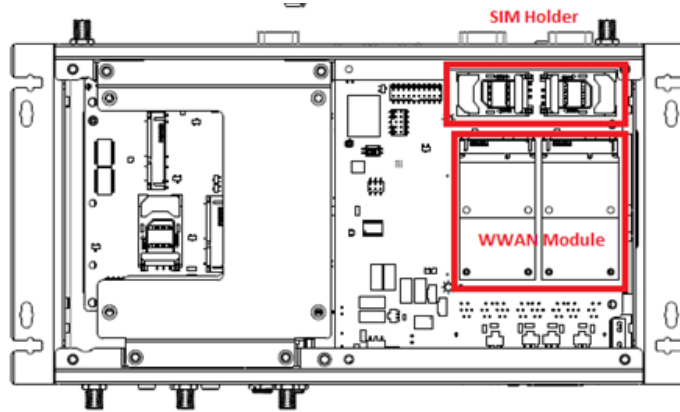

Chapter 3

Jumper and Switch Settings

This chapter explains how to set up ARK-2151V Series hardware, including instructions on setting jumpers and connecting peripherals, and how to set switches and read indicators.

Be sure to read all the safety precautions before beginning the installation procedure.

3.1 Setting Jumpers and Switches

It is possible to configure the In-Vehicle Computing Box to match the needs of the application by resetting the jumpers. A jumper is the simplest kind of electrical switch. It consists of two metal pins and a small metal clip, often protected by a plastic cover that slides over the pins to connect them. To “close” a jumper, connect the pins with the clip. To “open” a jumper, remove the clip. Sometimes a jumper has three pins, labeled 1, 2, and 3. In this case, connect either pins 1 and 2, or pins 2 and 3.

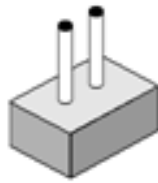

Open

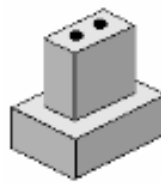

Closed

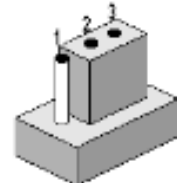

Closed 2-3

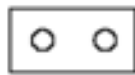

Open



Closed

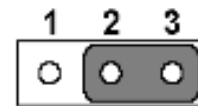

Closed 2-3

A pair of needle-nose pliers may be helpful when working with jumpers. If there are any doubts about the best hardware configuration for the application, contact the local distributor or sales representative before making any changes.

An arrow is used on the motherboard to indicate the first pin of each jumper.

3.1.1 Main Board

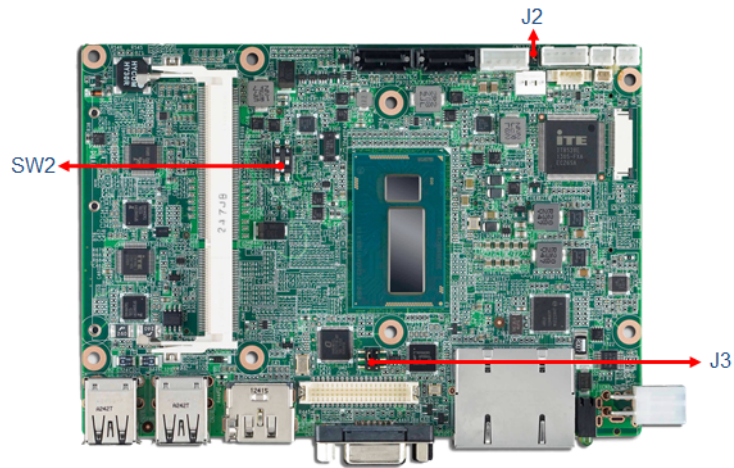

Figure 3.1 Top side of main board

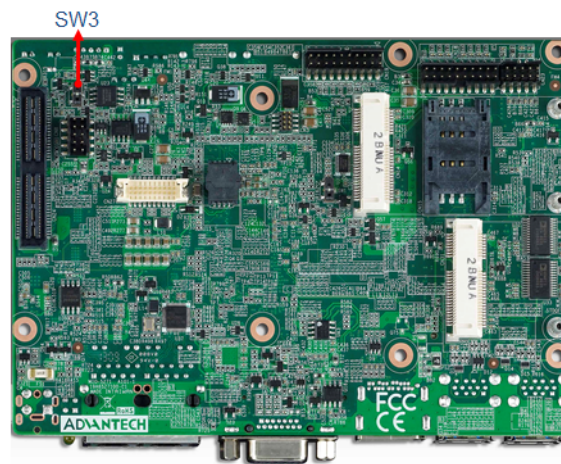

Figure 3.2 Bottom side of main board

3.1.2 I/O Board (ARK-2151V-S6A1E Only)

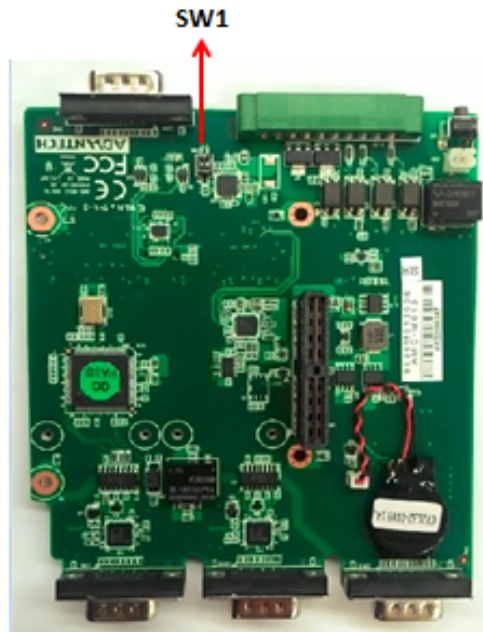

Figure 3.3 Top side of I/O board

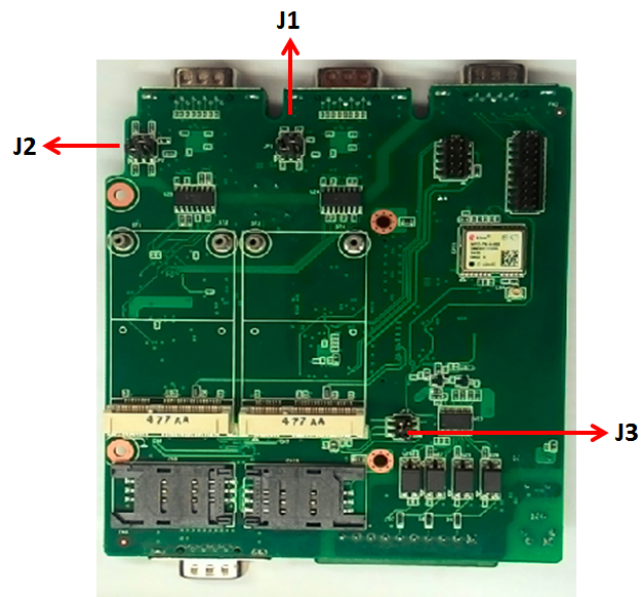

Figure 3.4 Bottom side of I/O board

3.1.3 I/O board (ARK-2151V-S9A1E Only)

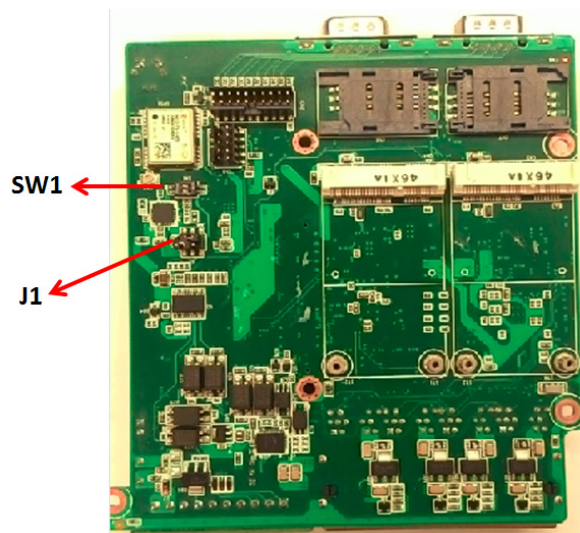

Figure 3.5 Bottom side of I/O board

3.1.4 Power Board

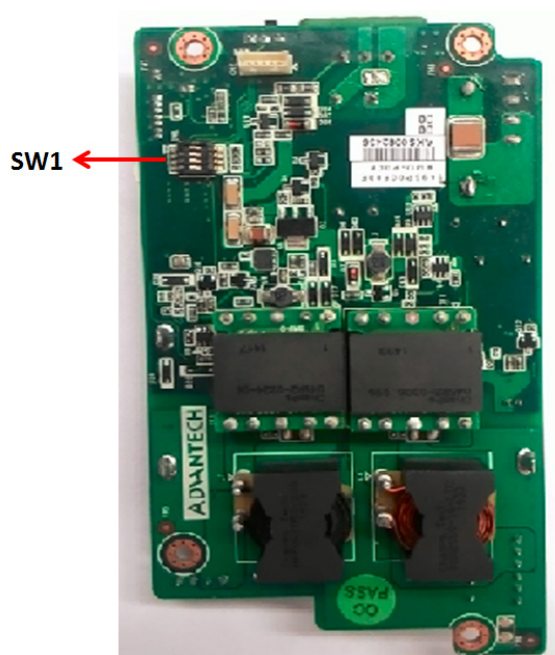

Figure 3.6 Top side of power board

3.2 Jumper Lists

3.2.1 Main Board

Jumpers & Switches

J2	Auto Power On Setting
J3	LCD Power
SW2	mPCIe & mSATA selection
SW3	Clear CMOS

3.2.2 I/O Board (ARK-2151V-S6A1E Only)

Jumper List

J1	RS232/422/485 Jumper Setting - COM2
J2	RS232/422/485 Jumper Setting - COM1
J3	3G Voice audio - PCM data in/out swap
SW1	3G/4G module Power Selection

3.2.3 I/O Board (ARK-2151V-S9A1E Only)

Jumper List

J1	WWAN voice audio - PCM data in/out swap
SW1	3G/4G module Power Selection

3.2.4 Power Board

Jumper List

SW1	Power Ignition HW Setting
-----	---------------------------

3.3 Jumper Settings

3.3.1 Main Board

3.3.1.1 Auto Power On Setting (J2)



Table 3.1: Auto Power On Setting (J2)

Setting	Function
NC	Power Button for Power On
(1-2)*	Auto Power On (default)

3.3.1.2 LCD Power (J3)

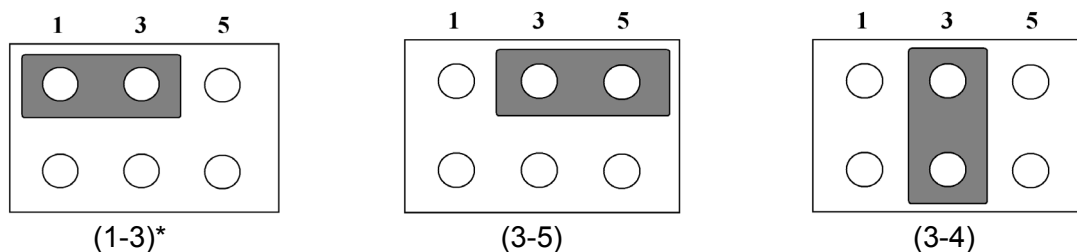

Table 3.2: LCD Power (J3)

Setting	Function
(1-3)*	+3.3 V (default)
(3-5)	+5 V
(3-4)	+12 V

3.3.1.3 PCIe & mSATA Selection (SW2)

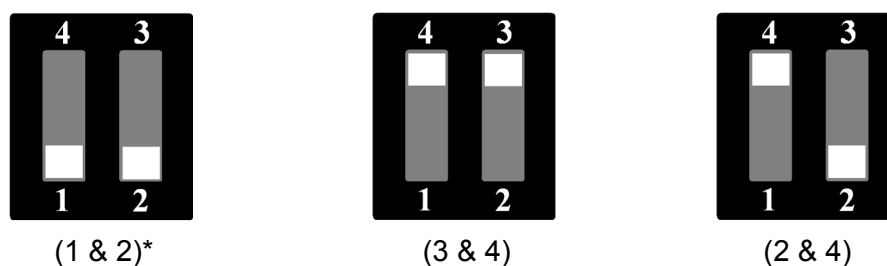

Table 3.3: mPCIe & mSATA Selection (SW2)

Setting	Function
(1 & 2)*	mSATA (default)
(3 & 4)	mPCIe
(2 & 4)	Auto Detect ¹

¹ Some of mSATA or mPCIe modules can't be recognized correctly through the Auto Detect setting. Suggest to use mSATA or mPCIe setting directly if meet any compatibility problem.

3.3.1.4 Clear CMOS (SW3)



Table 3.4: Clear CMOS (SW3)

Setting	Function
(1-2)*	Normal
(2-3)	Clear CMOS

3.3.2 I/O Board (ARK-2151V-S6A1E Only)

3.3.2.1 RS232/422/485 Jumper Setting - COM1 (J1)

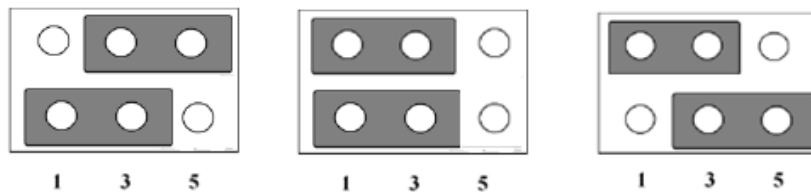

Table 3.5: RS232/422/485 Setting

Setting	Function
(1-3), (4-6) *	RS-232
(1-3), (2-4)	RS-422
(3-5), (2-4)	RS-485

3.3.2.2 RS232/422/485 Jumper Setting - COM2 (J2)

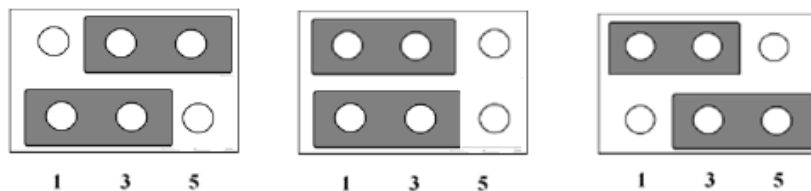

Table 3.6: RS232/422/485 Setting

Setting	Function
(1-3), (4-6) *	RS-232
(1-3), (2-4)	RS-422
(3-5), (2-4)	RS-485

3.3.2.3 WWAN voice audio - PCM data in/out swap (J3)

(1-3), (4-6) *

(1-3), (2-4)

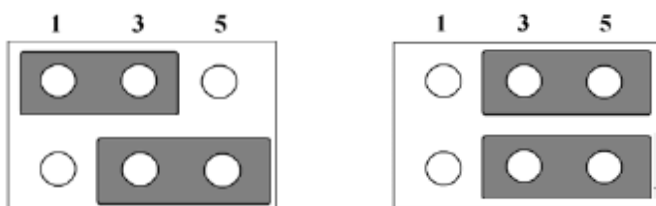

Table 3.7: WWAN Voice Audio -PCM Data In/Out Swap

Setting	Function
(1-3), (4-6) *	PCM_IN → PCMA_OUT; PCM_OUT → PCMA → IN
(3-5),(2-4)	PCM_IN → PCMA_IN; PCM_OUT → PCMA → Out

3.3.2.4 WWAN module Power Selection (SW1)

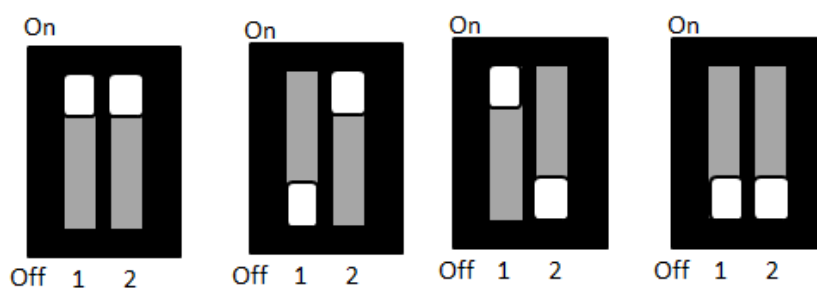

Table 3.8: WWAN Module Power Selection

Setting	Function
1(On), 2 (On)	3.6 V
1(Off), 2 (On)	3.5 V
1(On), 2 (Off)	3.4 V
1(Off),2 (Off)*	3.3 V

3.3.3 I/O Board (ARK-2151V-S9A1E Only)

3.3.3.1 WWAN voice audio - PCM data in/out swap (J1)

(1-3), (4-6) *

(1-3), (2-4)

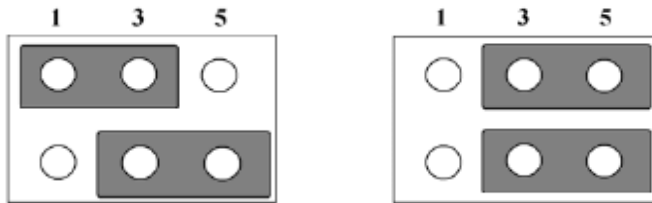

Table 3.9: 3G Voice Audio -PCM Data In/Out Swap

Setting	Function
(1-3), (4-6) *	PCM_IN → PCMA_OUT; PCM_OUT → PCMA → IN
(3-5),(2-4)	PCM_IN → PCMA_IN; PCM_OUT → PCMA → Out

3.3.3.2 3G/4G module Power Selection (SW1)

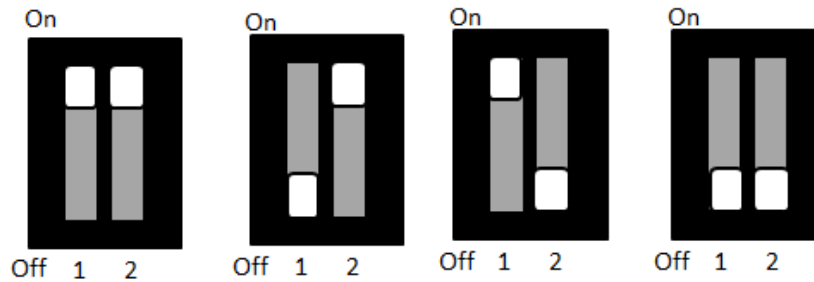

Table 3.10: 3G/4G Module Power Selection

Setting	Function
1(On), 2 (On)	3.6 V
1(Off), 2 (On)	3.5 V
1(On), 2 (Off)	3.4 V
1(Off),2 (Off)*	3.3 V

3.3.4 Power Board

3.3.4.1 Power Ignition HW Setting (SW1_1-3)

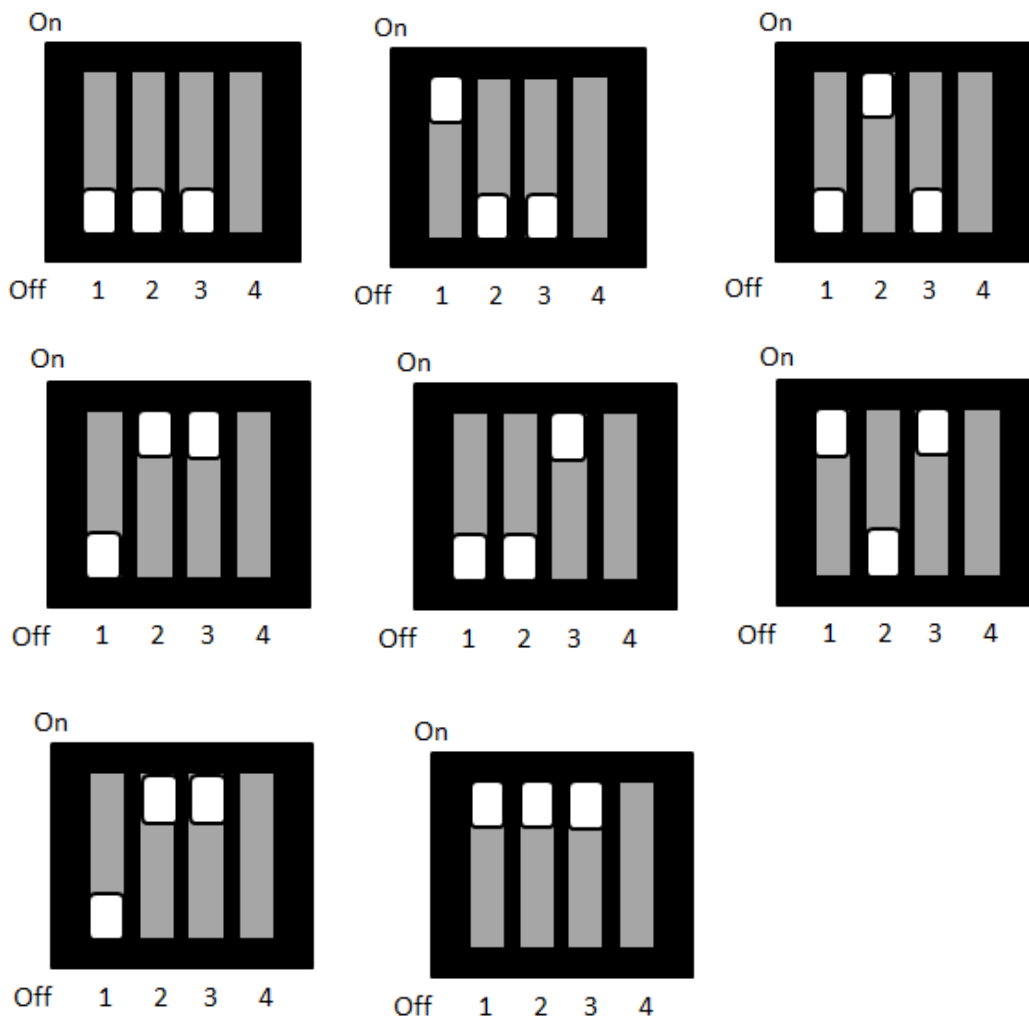

Table 3.11: Power Ignition HW Setting

Setting			Function		
1	2	3	Ignition on Timer	Ignition delay off timer	Ignition hard off timer
Off*	Off*	Off*	7	30	180
On	Off	Off	10	40	180
Off	On	Off	10	60	180
Off	On	On	30	60	180
Off	Off	On	60	120	180
On	Off	On	120	180	180
Off	On	On	180	240	180
On	On	On	7	0	180

3.3.4.2 Power Ignition SW/HW Setting (SW1_4)

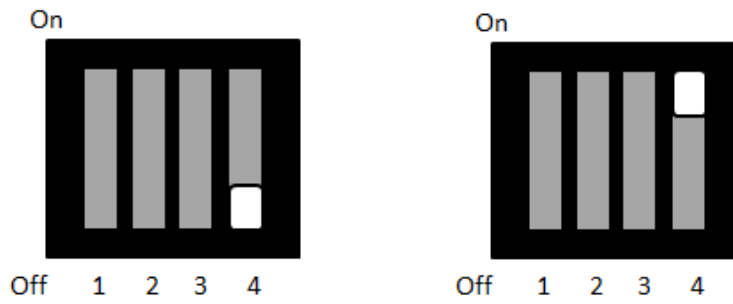

Table 3.12: Power Ignition SW/HW Setting Selection

Setting	Function
Off*	Power Ignition SW setting
On	Power Ignition HW setting

Chapter 4

Pin Assignments

This chapter explains Pin Assignments of ARK-2151V Series.

4.1 ARK-2151V-S6A1E I/O Connectors

4.1.1 ARK-2151V-S6A1E Front I/O View

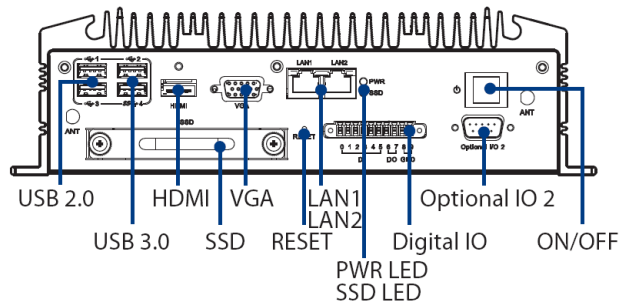

4.1.2 ARK-2151V-S6A1E Rear I/O View

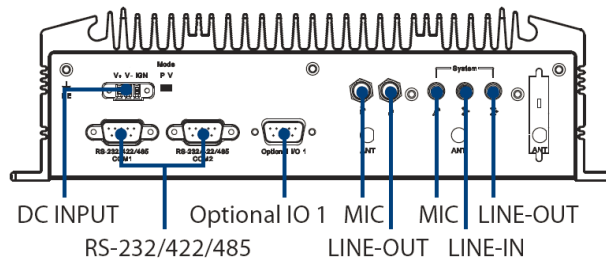

4.2 ARK-2151V-S6A1E I/O Pin Definition

4.2.1 VGA Connector

The ARK-2151V provides a high resolution VGA interface connected by a D-sub 15-pin connector to support a VGA CRT monitor. It supports display resolution of up to 1920 x 1200 with 60 Hz.

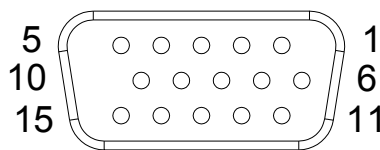

Figure 4.1 VGA Connector

Table 4.1: VGA Connector Pin Assignments

Pin	Signal Name	Pin	Signal Name
1	Red	2	Green
3	Blue	4	NC
5	GND	6	GND
7	GND	8	GND
9	NC	10	GND
11	NC	12	DDC Date
13	H-SYNC	14	V-SYNC
15	DDC Clock		

4.2.2 USB Connector

The ARK-2151V provides up to four USB interface connectors - 2 x USB 2.0 & 2 x USB 3.0, which give complete Plug & Play. The USB interface is compliant with USB UHCI, Rev. 2.0 & 3.0. The USB interface supports Plug and Play, which enables you to connect or disconnect a device whenever you want, without turning off the computer.

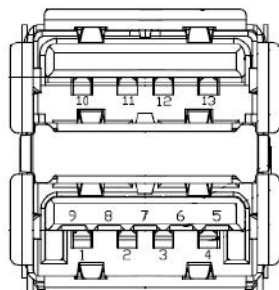

Figure 4.2 USB Connector [Upper (black): USB2.0 / Down (blue): USB 3.0]

Table 4.2: USB Connector Pin Assignments

Pin	Signal Name	Pin	Signal Name
1	+5V	2	D-
3	D+	4	GND
5	SSRX-	6	SSRX+
7	GND	8	SSTX-
9	SSTX+	10	+5V
11	D-	12	D+
13	GND		

4.2.3 Ethernet Connector

ARK-2151V provides two RJ45 LAN interface connectors, which are fully compliant with IEEE 802.3u 10/100/1000 Base-T CSMA/CD standards. LAN1 is equipped with Intel I218 GbE and LAN2 is equipped with Intel I210 GbE. The Ethernet ports use standard RJ-45 jack connectors with LED indicators on the front side to show Active/Link status and Speed status.

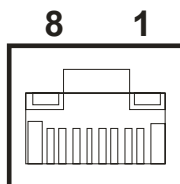

Figure 4.3 Ethernet Connector

Table 4.3: Ethernet Connector Pin Assignments

Pin	Signal Name	Pin	Signal Name
1	TX+(10/100),BI_DA+(GHz)	5	BI_DC-(GHz)
2	TX-(10/100),BI_DA-(GHz)	6	RX-(10/100),BI_DB-(GHz)
3	RX+(10/100),BI_DB+(GHz)	7	BI_DD+(GHz)
4	BI_DC+(GHz)	8	BI_DD-(GHz)

4.2.4 HDMI Connector

ARK-2151V provides 1 x lockable HDMI port which resolution can support up to 4K at 24 Hz.

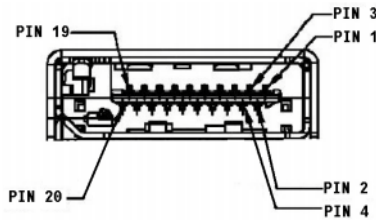

Figure 4.4 HDMI Connector

Table 4.4: HDMI / Display Port Connector Pin Assignments

Pin	Signal Name	Pin	Signal Name
1	TMDS_Data2+/ DP_Data0+	2	GND
3	TMDS_Data2-/ DP_Data0-	4	TMDS_Data1+/ DP_Data1+
5	GND	6	TMDS_Data1-/ DP_Data1-
7	TMDS_Data0+/ DP_Data2+	8	GND
9	TMDS_Data0-/ DP_Data2-	10	TMDS_Clock+/ DP_Data3+
11	GND	12	TMDS_Clock-/ DP_Data3-
13	NC	14	NC
15	SCL/ AUX_CH+	16	SDA/ GND
17	DDC GND/ AUX_CH-	18	+5V/ Hot plug detect
19	Hot plug detect/ Return	20	DP_PWR

4.2.5 DIO Connector

ARK-2151V offers an 8-bit phoenix type DIO connector and two ground pin. 6 x DI & 2 x DO w/ 3 KV isolation.

- **Connector Type:** 10-pin screw terminal block (6 DI points, 2 DO points, GND)
- **Input Voltage:** 0 to 30 VDC at 25 Hz
- **Digital Input Levels for Dry Contacts:**
 - Logic level 0: Close to GND
 - Logic level 1: Open
- **Digital Input Levels for Wet Contacts:**
 - Logic level 0: +3 V max.
 - Logic level 1: +5 V to +30 V
- **Output Current:** Max. 500 mA per channel
- **On-state Voltage:** 24 VDC nominal, open collector to 30 VDC

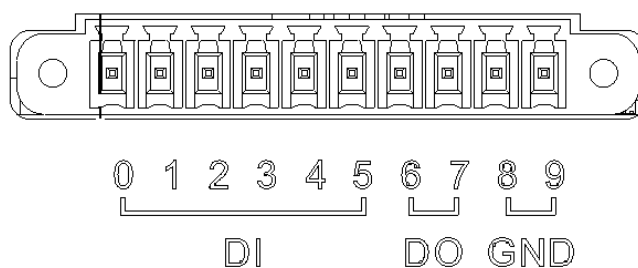

Figure 4.5 DIO Connector

4.2.6 Power Input Connector

ARK-2151V comes with 3-pin phenix type power input connector for 9 ~ 36 VDC input.

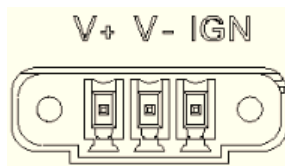

Figure 4.6 Power Input Connector

4.2.7 COM Connector

ARK-2151V-S6A1E provides two D-sub 9-pin connectors, which offers 2 x RS-232/422/485 serial communication ports w/ 3 KV isolation. (Jumper setting selectable)

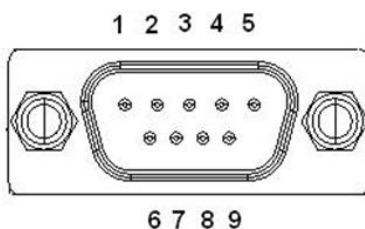

Figure 4.7 COM Port Connector

Table 4.5: COM Connector Pin Assignments

Pin	RS-232	RS-422	RS-485
	Signal Name	Signal Name	Signal Name
1	DCD	Tx-	DATA-
2	RxD	Tx+	DATA+
3	TxD	Rx+	NC
4	DTR	Rx-	NC
5	GND	GND	GND
6	DSR	NC	NC
7	RTS	NC	NC
8	CTS	NC	NC
9	RI	NC	NC

4.2.8 System Audio Connector

ARK-2151V offers stereo audio ports by a phone jack connector of Line-out, Mic-in & Line-in. The audio chip controller is by Realtek ALC888, High Definition Audio.

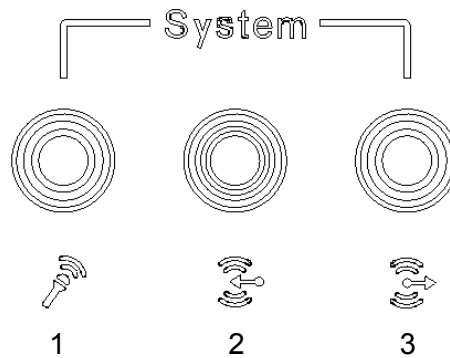

Figure 4.8 System Audio Connector

Table 4.6: Audio Connector Pin Assignments

Pin	Audio Signal Name
1	MIC
2	Line-In
3	Line-Out

4.2.9 Cellular Voice Connector

ARK-2151V offers stereo audio ports by a phone jack connector of Line-out & Mic-in.

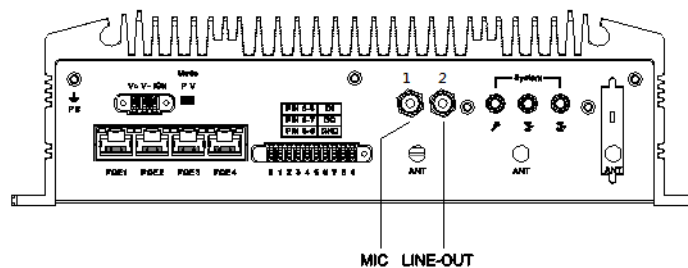

Figure 4.9 Cellular Voice Connector

Table 4.7: Cellular Voice Connector Pin Assignments

Pin	Cellular Signal Name
1	MIC
2	Line Out

4.2.10 Optional I/O

ARK-2151V-S6A1E provides two optional DB9 connectors which can have possible combination as below.

- 2 x DB9 connectors for RS-232/422/485 signal (Default)
- CANBus 2.0A/B (Module option)

DB9_1	DB9_2
COM	COM
1 x CANBus	1 x CANBus
COM	2 x CANBus
2 x CANBus	COM

4.2.11 Power Input Mode

ARK-2151V provides two power input mode. One is P and the other one is V. P means for power adapter; V means for in-vehicle purpose.



Figure 4.10 Power Input Mode

4.2.12 Power On/Off Button

ARK-2151V comes with a Power On/Off button, that support dual function of Soft Power -On/Off (Instant off or Delay 4 Second), and Suspend.

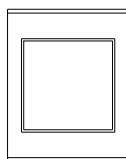

Figure 4.11 Power ON/OFF Button

4.2.13 Reset

ARK-2151V comes with reset function for users to reset the unit if necessary.



Figure 4.12 Reset

4.2.14 LED Indicator

There are two LEDs on ARK-2151V front metal face plate for indicating system status: PWR LED is for power status; and SSD LED is for SSD flash disk status.



Figure 4.13 LED Indicator

4.3 ARK-2151V-S9A1E I/O Connectors

4.3.1 ARK-2151V-S9A1E Front I/O View

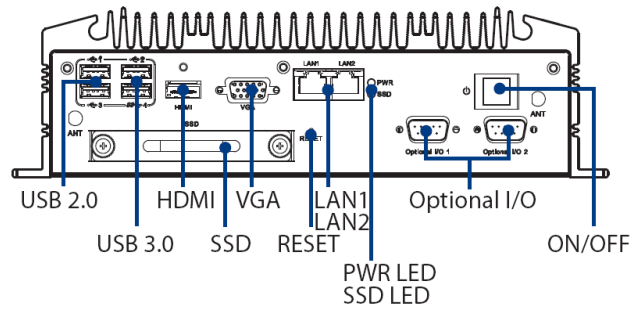

4.3.2 ARK-2151V-S9A1E Rear I/O View

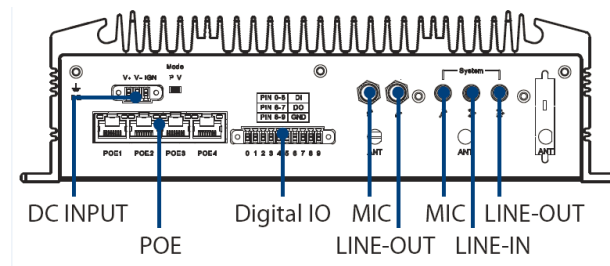

4.4 ARK-2151V-S9A1E I/O Pin Definition

4.4.1 VGA Connector

The ARK-2151V provides a high resolution VGA interface connected by a D-sub 15-pin connector to support a VGA CRT monitor. It supports display resolution of up to 1920 x 1200 with 60 Hz.

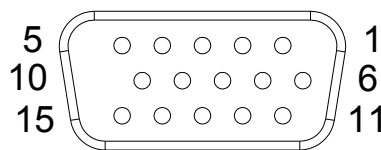

Figure 4.14 VGA Connector

Table 4.8: VGA Connector Pin Assignments

Pin	Signal Name	Pin	Signal Name
1	Red	2	Green
3	Blue	4	NC
5	GND	6	GND
7	GND	8	GND
9	NC	10	GND
11	NC	12	DDC Date
13	H-SYNC	14	V-SYNC
15	DDC Clock		

4.4.2 USB Connector

The ARK-2151V provides up to four USB interface connectors - 2 x USB 2.0 & 2 x USB 3.0, which give complete Plug & Play. The USB interface is compliant with USB UHCI, Rev. 2.0 & 3.0. The USB interface supports Plug and Play, which enables you to connect or disconnect a device whenever you want, without turning off the computer.

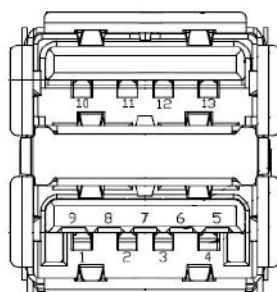

Figure 4.15 USB Connector [Upper (black): USB2.0 / Down (blue): USB 3.0]

Table 4.9: USB Connector Pin Assignments

Pin	Signal Name	Pin	Signal Name
1	+5V	2	D-
3	D+	4	GND
5	SSRX-	6	SSRX+
7	GND	8	SSTX-
9	SSTX+	10	+5V
11	D-	12	D+
13	GND		

4.4.3 Ethernet Connector

ARK-2151V provides two RJ45 LAN interface connectors, which are fully compliant with IEEE 802.3u 10/100/1000 Base-T CSMA/CD standards. LAN1 is equipped with Intel I218 GbE and LAN2 is equipped with Intel I210 GbE. The Ethernet ports use standard RJ-45 jack connectors with LED indicators on the front side to show Active/Link status and Speed status.

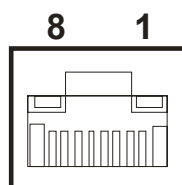

Figure 4.16 Ethernet Connector

Table 4.10: Ethernet Connector Pin Assignments

Pin	Signal Name	Pin	Signal Name
1	TX+(10/100),BI_DA+(GHz)	5	BI_DC-(GHz)
2	TX-(10/100),BI_DA-(GHz)	6	RX-(10/100),BI_DB-(GHz)
3	RX+(10/100),BI_DB+(GHz)	7	BI_DD+(GHz)
4	BI_DC+(GHz)	8	BI_DD-(GHz)

4.4.4 HDMI Connector

ARK-2151V provides 1 x lockable HDMI port which resolution can support up to 4K at 24 Hz.

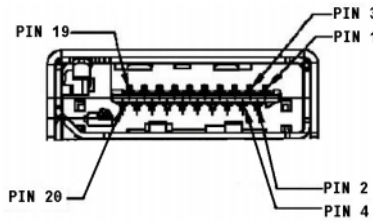

Figure 4.17 HDMI Connector

Table 4.11: HDMI / Display Port Connector Pin Assignments

Pin	Signal Name	Pin	Signal Name
1	TMDS_Data2+/ DP_Data0+	2	GND
3	TMDS_Data2-/ DP_Data0-	4	TMDS_Data1+/ DP_Data1+
5	GND	6	TMDS_Data1-/ DP_Data1-
7	TMDS_Data0+/ DP_Data2+	8	GND
9	TMDS_Data0-/ DP_Data2-	10	TMDS_Clock+/ DP_Data3+
11	GND	12	TMDS_Clock-/ DP_Data3-
13	NC	14	NC
15	SCL/ AUX_CH+	16	SDA/ GND
17	DDC GND/ AUX_CH-	18	+5V/ Hot plug detect
19	Hot plug detect/ Return	20	DP_PWR

4.4.5 DIO Connector

ARK-2151V offers an 8-bit phenix type DIO connector and two ground pin. 6 x DI & 2 x DO w/ 3 KV isolation.

- **Connector Type:** 10-pin screw terminal block (6 DI points, 2 DO points, GND)
- **Input Voltage:** 0 to 30 VDC at 25 Hz
- **Digital Input Levels for Dry Contacts:**
 - Logic level 0: Close to GND
 - Logic level 1: Open
- **Digital Input Levels for Wet Contacts:**
 - Logic level 0: +3 V max.
 - Logic level 1: +5 V to +30 V
- **Output Current:** Max. 500 mA per channel
- **On-state Voltage:** 24 VDC nominal, open collector to 30 VDC

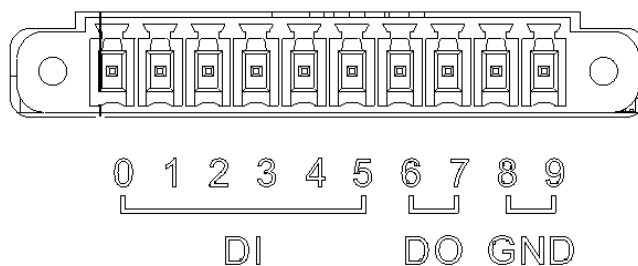

Figure 4.18 DIO Connector

4.4.6 Power Input Connector

ARK-2151V comes with 3-pin phoenix type power input connector for 9 ~ 36 VDC input.

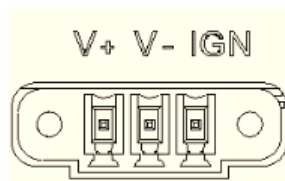

Figure 4.19 Power Input Connector

4.4.7 Power Over Ethernet

ARK-2151V-S9A1E provides 4 x 10/100 PoE ports.

- 4ports full-load, IEEE802.3af Class 2 (7 Watt)
- 2ports full-load, IEEE802.3af Class 3 (15.4 Watt)

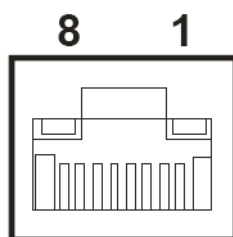

Figure 4.20 Power Over Ethernet Connector

Table 4.12: Power Over Ethernet (PoE) Pin Definition

Pin	Signal Name	Pin	Signal Name
1	Rx + / DC +	5	unused
2	RX - / DC +	6	Tx - / DC -
3	Tx + / DC -	7	Unused
4	Unused	8	Unused

4.4.8 System Audio Connector

ARK-2151V offers stereo audio ports by a phone jack connector of Line-out, Mic-in & Line-in. The audio chip controller is by Realtek ALC888, High Definition Audio.

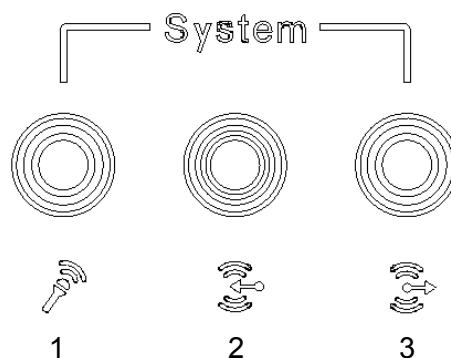

Figure 4.21 System Audio Connector

Table 4.13: Audio Connector Pin Assignments

Pin	Audio Signal Name
1	MIC
2	Line-In
3	Line-Out

4.4.9 Cellular Voice Connector

ARK-2151V offers stereo audio ports by a phone jack connector of Line-out & Mic-in.

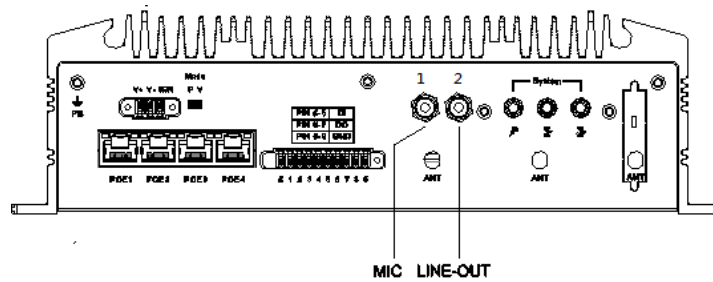

Figure 4.22 Cellular Voice Connector

Table 4.14: Cellular Voice Connector Pin Assignments

Pin	Cellular Signal Name
1	MIC
2	Line Out

4.4.10 Optional I/O

ARK-2151V-S9A1E provides two optional DB9 connectors which can have possible combination as below.

- 2 x DB9 connectors for RS-232/422/485 signal (Default)
- CANBus 2.0A/B (Module option)

DB9_1	DB9_2
COM	COM
1 x CANBus	1 x CANBus
COM	2 x CANBus
2 x CANBus	COM

4.4.11 Power Input Mode

ARK-2151V provides two power input mode. One is P and the other one is V. P means for power adapter; V means for in-vehicle purpose.

Mode

P V



Figure 4.23 Power Input Mode

4.4.12 Power On/Off Button

ARK-2151V comes with a Power On/Off button, that support dual function of Soft Power -On/Off (Instant off or Delay 4 Second), and Suspend.

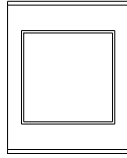

Figure 4.24 Power ON/OFF Button

4.4.13 Reset

ARK-2151V comes with reset function for users to reset the unit if necessary.



Figure 4.25 Reset

4.4.14 LED Indicator

There are two LEDs on ARK-2151V front metal face plate for indicating system status: PWR LED is for power status; and SSD LED is for SSD flash disk status.



Figure 4.26 LED Indicator

Chapter 5

BIOS settings

This chapter introduces how to set BIOS configuration data.

5.1 Introduction

AMIBIOS has been integrated into many motherboards for over a decade. With the AMIBIOS Setup program, you can modify BIOS settings and control the various system features. This chapter describes the basic navigation of the ARK-2151V BIOS setup screens.

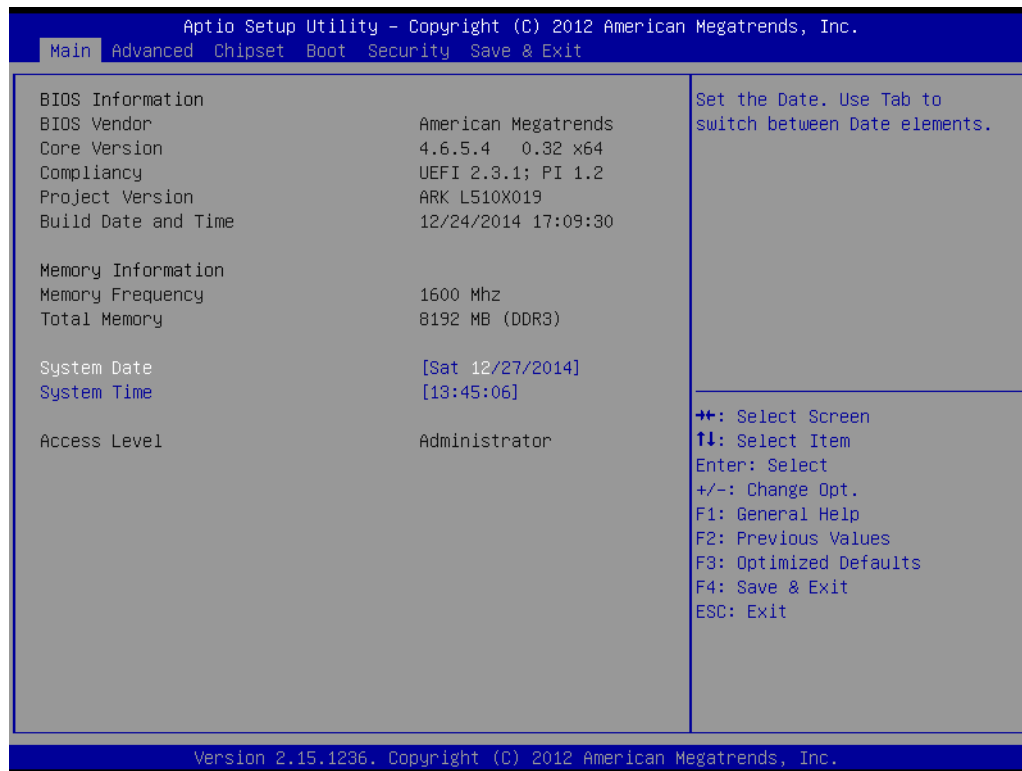

Figure 5.1 Setup program initial screen

AMI's BIOS ROM has a built-in setup program that allows users to modify the basic system configuration. This information is stored in battery-backed CMOS so it retains the setup information when the power is turned off.

5.2 Entering Setup

Turn on the computer and then press <F2> or to enter the Setup menu.

5.2.1 Main Setup

When you first enter the BIOS Setup Utility, you will enter the Main setup screen. You can always return to the Main setup screen by selecting the Main tab. There are two Main Setup options. They are described in this section. The Main BIOS Setup screen is shown below.

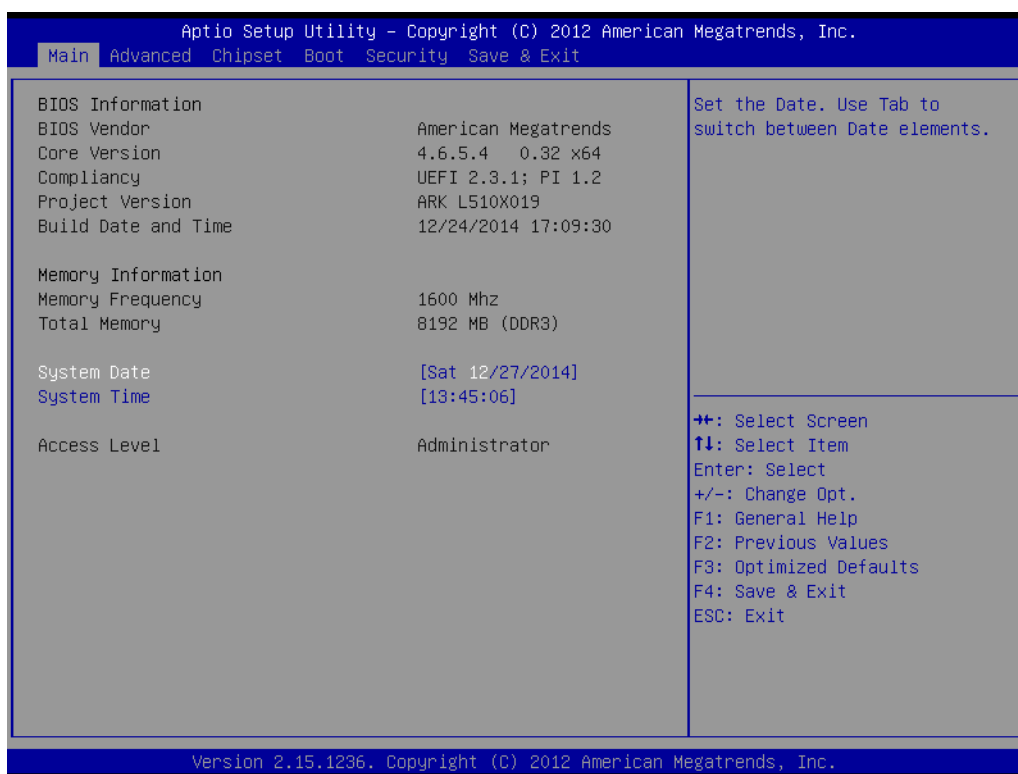

Figure 5.2 Main setup screen

The Main BIOS setup screen has two main frames. The left frame displays all the options that can be configured. Grayed-out options cannot be configured; options in blue can. The right frame displays the key legend.

Above the key legend is an area reserved for a text message. When an option is selected in the left frame, it is highlighted in white. Often a text message will accompany it.

■ System Time / System Date

Use this option to change the system time and date. Highlight System Time or System Date using the <Arrow> keys. Enter new values through the keyboard. Press the <Tab> key or the <Arrow> keys to move between fields. The date must be entered in MM/DD/YY format. The time must be entered in HH:MM:SS format.

5.2.2 Advanced BIOS Features Setup

Select the Advanced tab from the ARK-2151V setup screen to enter the Advanced BIOS Setup screen. You can select any of the items in the left frame of the screen, such as CPU Configuration, to go to the sub menu for that item. You can display an Advanced BIOS Setup option by highlighting it using the <Arrow> keys. All Advanced BIOS Setup options are described in this section. The Advanced BIOS Setup screens are shown below. The sub menus are described on the following pages.

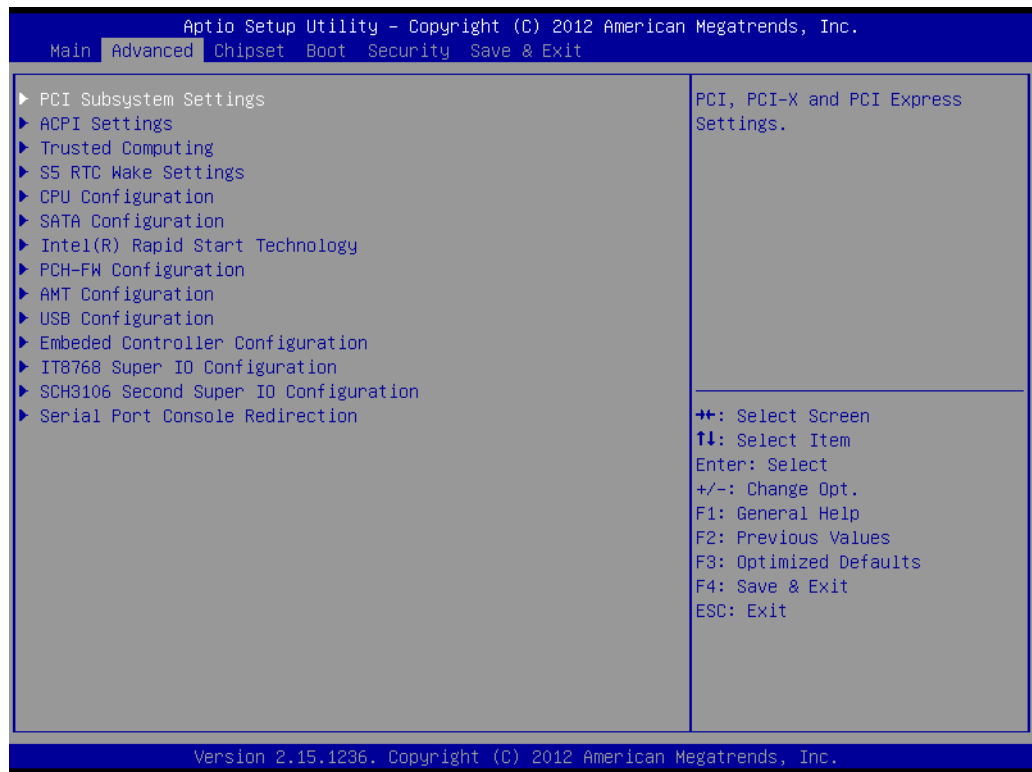

Figure 5.3 Advanced BIOS features setup screen

5.2.2.1 PCI Subsystem Settings

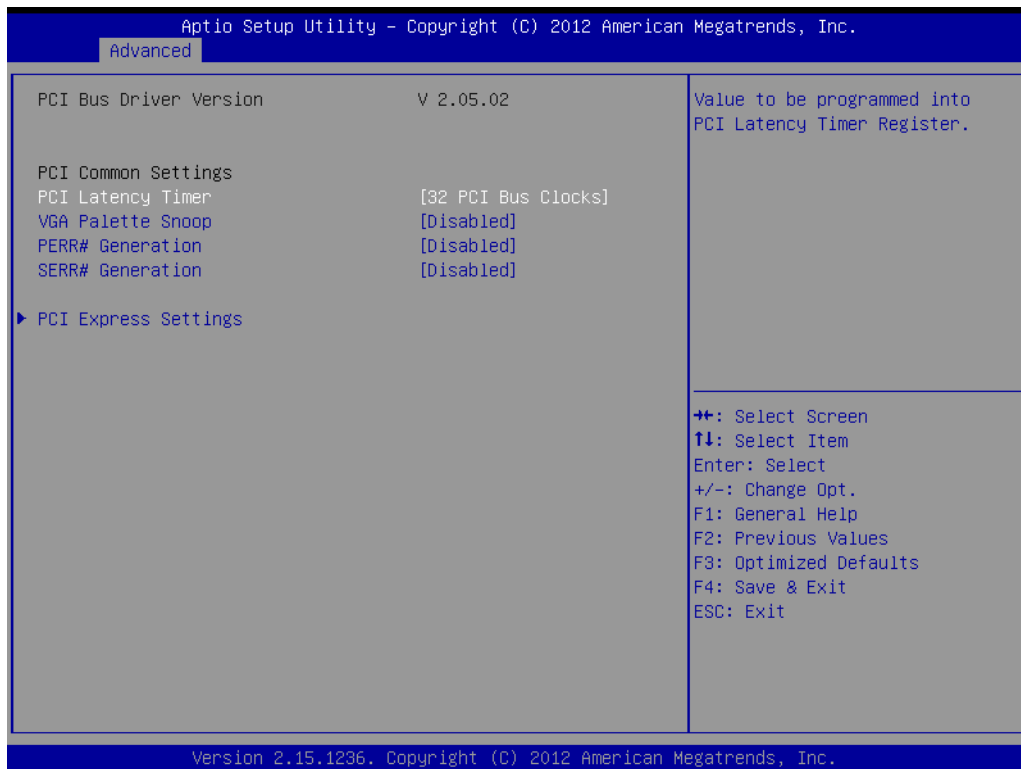

Figure 5.4 PCI Subsystem Settings

- **PCI Latency Timer**
This item allows users to program the PCI Latency timer.
- **VGA Palette Snoop**
This item allows users to enable or disable VGA Palette Snoop.
- **PERR# Generation**
This item allows users to enable or disable PERR# Generation.
- **SERR# Generation**
This item allows users to enable or disable SERR# Generation

5.2.2.2 PCI Express Device Register Settings

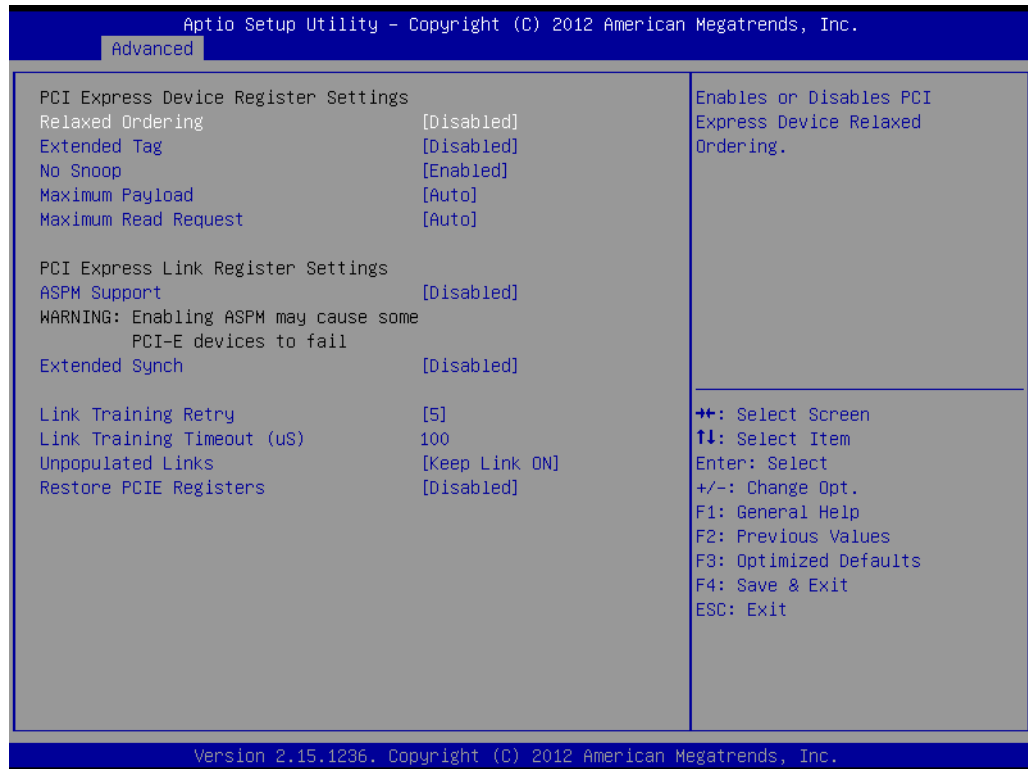

Figure 5.5 PCI Express Device Register Settings

- **Relaxed Ordering**
Enable or disable Relaxed Ordering.
- **Extended Tag**
Enable or disable Extended Tag.
- **No Snoop**
Enable or disable No Snoop.
- **Maximum Payload**
This item allows users to set the Maximum Payload.
- **Maximum Read Request**
This item allows users to set the Maximum Read Request.
- **ASPM Support**
Enable or disable ASPM Support.
- **Extended Synch**
Enable or disable Extended Synch.
- **Link Training Retry**
This item allows users to set the Link Training Retry.
- **Link Training Timeout (uS)**
This item allows users to set the Link Training Timeout (uS).
- **Unpopulated Links**
This item allows users to set the Unpopulated Links.
- **Restore PCIE Registers**
Enable or disable Restore PCIE Registers.

5.2.2.3 ACPI Settings

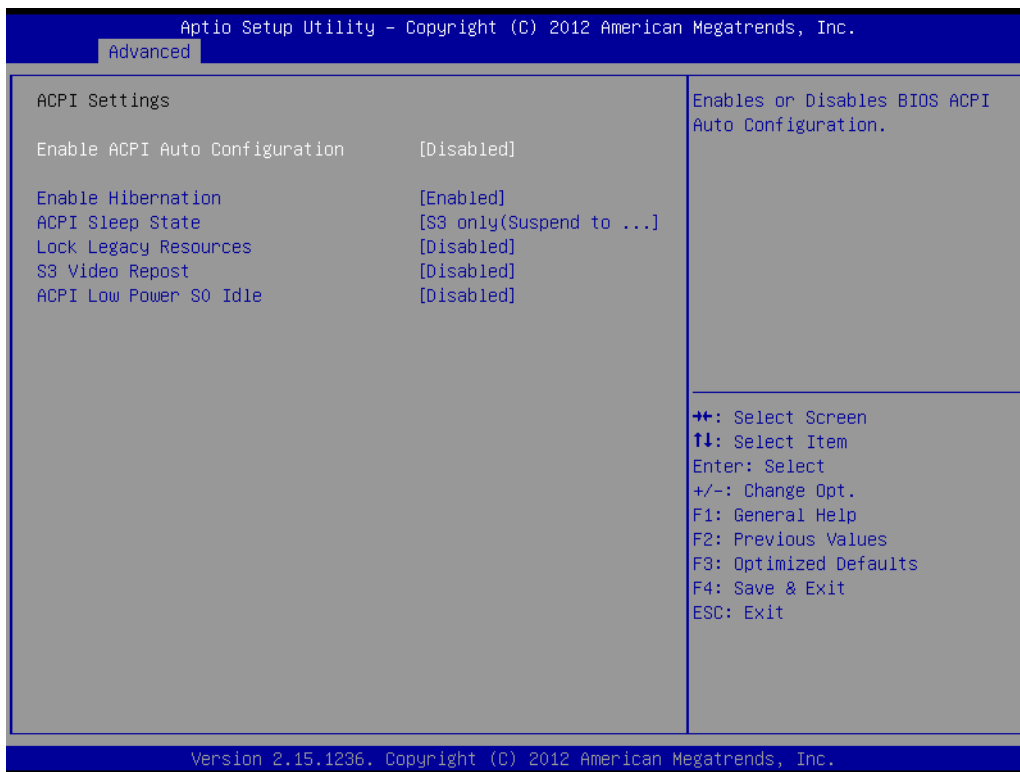

Figure 5.6 ACPI Setting

- **Enable ACPI Auto Configuration**
This item allows users to enable or disable BIOS ACPI auto configuration.
- **Enable Hibernation**
This item allows users to enable or disable hibernation.
- **ACPI Sleep State**
This item allows users to set the ACPI sleep state.
- **Lock Legacy Resources**
This item allows users to lock legacy devices' resources.
- **S3 Video Repost**
This item allows users to enable or disable VBIOS run after S3 resume.
- **ACPI Low Power S0 Idle**
This item allows users to enable or disable system wake on alarm event by Items setting.

5.2.2.4 Trusted Computing

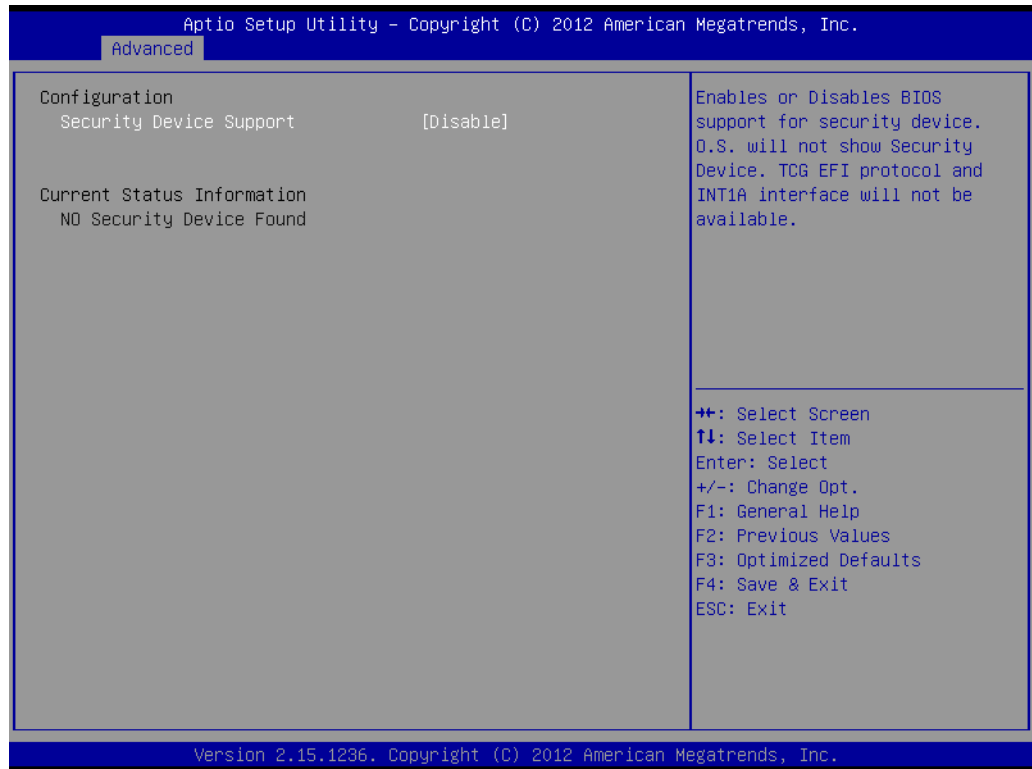

Figure 5.7 Trusted Computing Configuration

- **Security Device Support**
Enable or disable BIOS support for security device.

5.2.2.5 S5 RTC Wake Settings



Figure 5.8 S5 RTC Wake Settings

- **Wake system with fixed time**
Enable or disable system wake on alarm event.

5.2.2.6 CPU Configuration

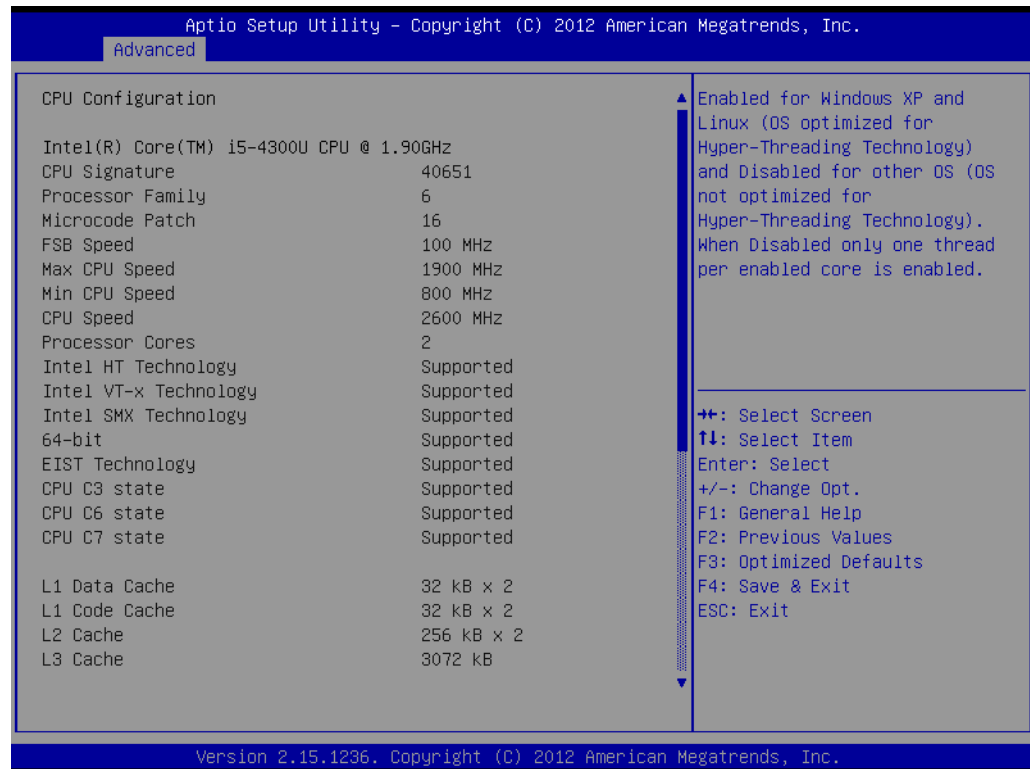

Figure 5.9 CPU Configuration Setting

- **Hyper Threading Technology**
This item allows users to enable or disable Intel Hyper Threading technology.
- **Active Processor Cores**
This item allows users to set how many processor cores should be active.
- **Limit CPUID Maximum**
This item allows users to limit the maximum value of CPUID.
- **Execute Disable Bit**
This item allows users to enable or disable the No-Execution page protection technology.
- **Intel Virtualization Technology**
This item allows users to enable or disable intel's virtualization technology.
- **Hardware Prefetcher**
This item allows users to enable or disable the hardware prefetcher feature.
- **Adjacent Cache Line Prefetch**
This item allows users to enable or disable the adjacent cache line prefetch feature.

5.2.2.7 SATA Configuration

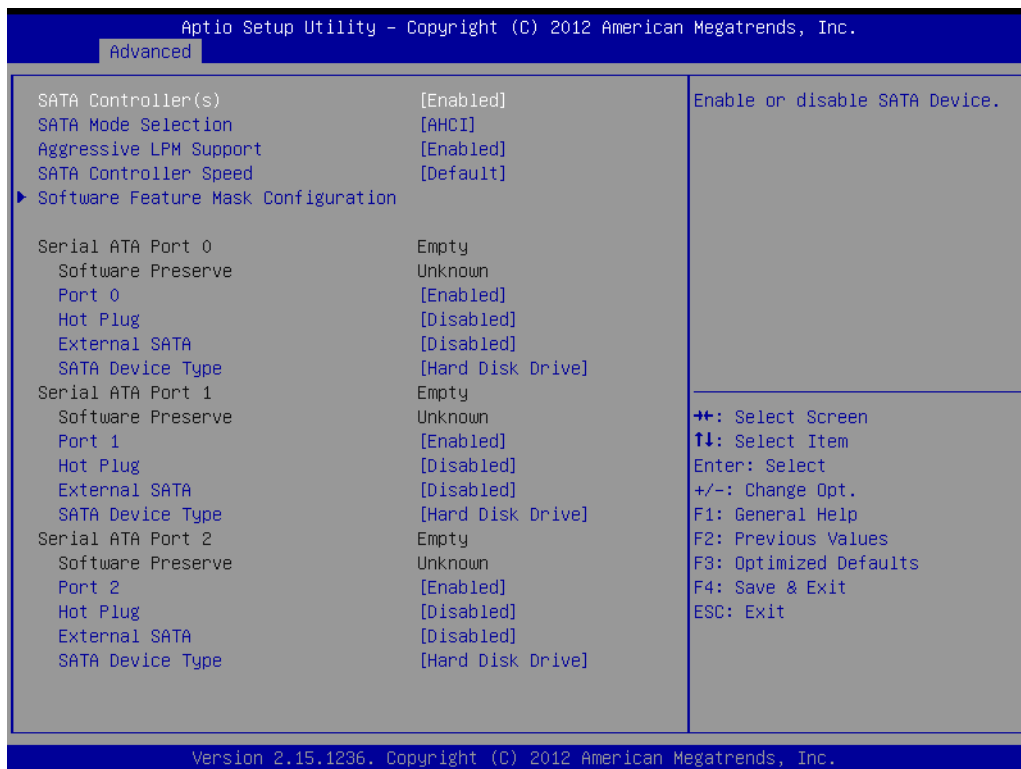

Figure 5.10 SATA Configuration

- **SATA Controller(s)**
This item allows users to enable or disable the SATA controller(s).
- **SATA Mode Selection**
This item allows users to select mode of SATA controller(s).
- **SATA Controller(s)**
This item allows users to enable or disable the SATA controller(s).
- **SATA Mode Selection**
This item allows users to select mode of SATA controller(s).
- **Aggressive LPM Support**
This item allows users to enable or disable the Aggressive LPM Support.
- **SATA Controller Speed**
This item allows users to select mode of SATA Controller Speed.
- **Serial ATA Port 1/2/3**
This item allows users to enable or disable the SATA Port.
- **Hot Plug**
This item allows users to enable or disable the Hot Plug.
- **External SATA**
This item allows users to enable or disable the External SATA.
- **SATA Device type**
This item allows users to select mode of SATA Device type.

5.2.2.8 Intel® Rapid Start Technology

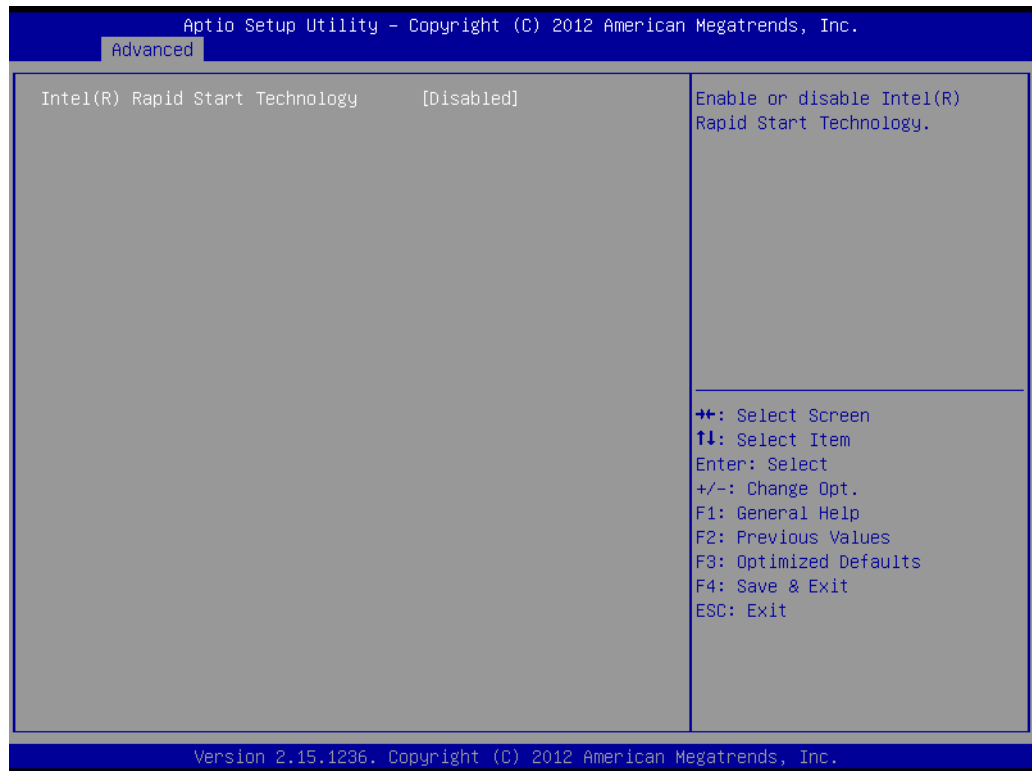

Figure 5.11 Intel® Rapid Technology

- **Intel® Rapid Start Technology**
This item allows users to enable or disable Rapid Start Technology, if supported.

5.2.2.9 AMT Configuration

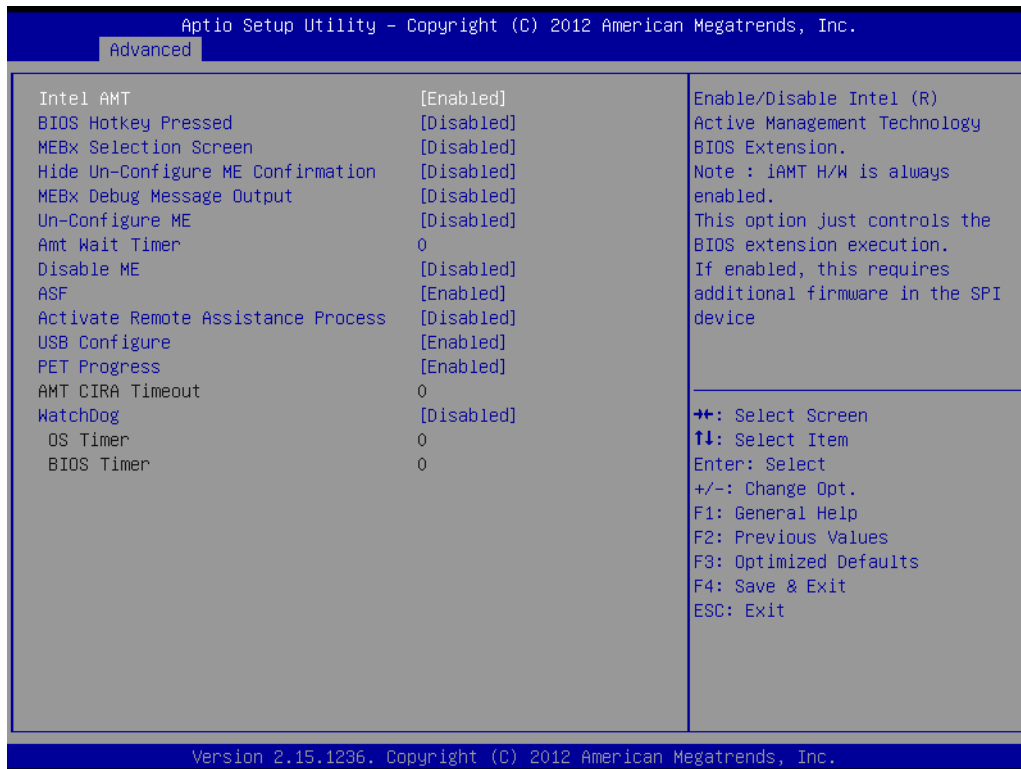

Figure 5.12 AMT Configuration

- **Intel AMT**
This item allows users to enable or disable Intel AMT BIOS extension.
- **BIOS Hotkey Pressed**
This item allows users to enable or disable BIOS hotkey press.
- **MEBx Selection Screen**
This item allows users to enable or disable MEBx selection screen.
- **Hide Un-Configuration ME Confirmation**
This item allows users to hide un-configure ME without password confirmation prompt.
- **MEBx Debug Message Output**
This item allows users to enable or disable MEBx debug message.
- **Un-Configure ME**
This item allows users to un-configure ME without password.
- **Amt Wait Timer**
Set timer to wait before sending ASF_GET_BOOT_OPTIONS.
- **Disable ME**
This item allows users to enable or disable Intel ME.
- **ASF**
This item allows users to enable or disable Alert Specification Format.
- **Activate Remote Assistance Process**
This item allows users to enable or disable trigger CIRA boot.
- **USB Configure**
This item allows users to enable or disable USB configure function.

- **PET Progress**
This item allows users to enable or disable PET events progress to receive PET events or not.
- **AMT CIRA Timeout**
OEM defined timeout for MPS connection to be established.
- **WatchDog**
This item allows users to enable or disable WatchDog Timer.
- **OS Timer**
Set OS watchdog timer.
- **BIOS Timer**
Set BIOS watchdog timer.

5.2.2.10 PCH-FW Configuration

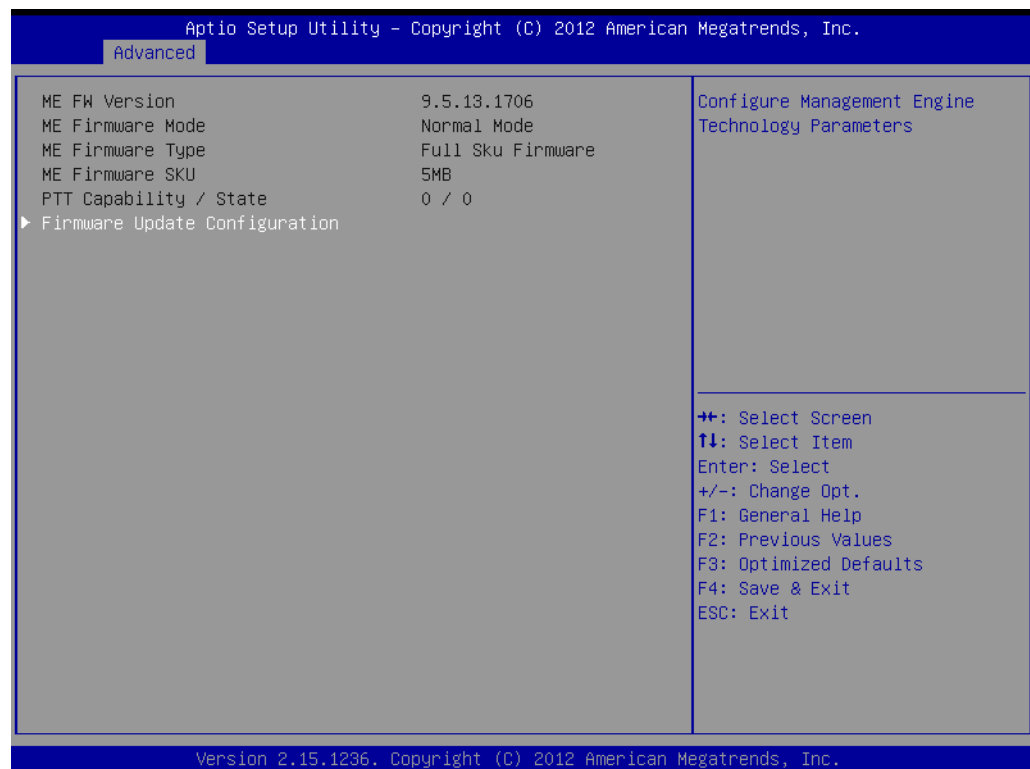

Figure 5.13 PCH-FW Configuration

- **Firmware Update Configuration**
This item allows users to enable or disable ME FW image re-flash function.

5.2.2.11 USB Configuration

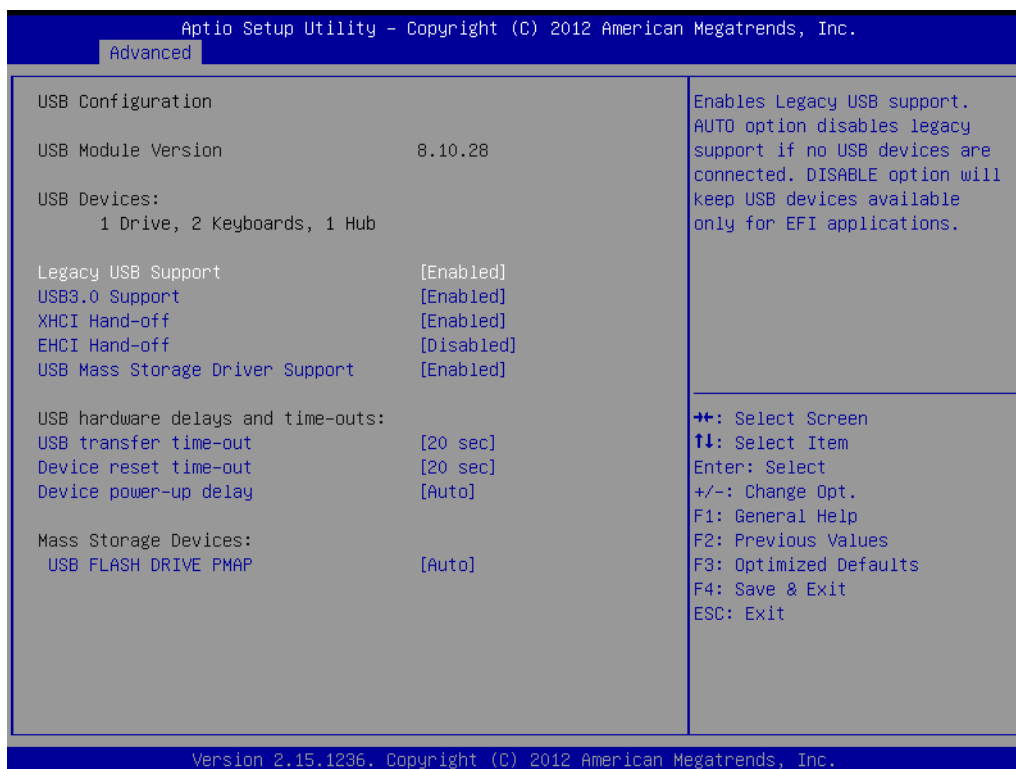

Figure 5.14 USB Configuration

- **Legacy USB Support**
Enable support for legacy USB. Auto option disables legacy support if no USB devices are connected.
- **USB3.0 Support**
This item allows users to enable or disable USB 3.0 support.
- **XHCI Hand-Off**
This is a workaround for the OS without XHCI hand-off support. The XHCI ownership change should claim by XHCI driver.
- **EHCI Hand-Off**
This is a workaround for the OS without EHCI hand-off support. The EHCI ownership change should claim by EHCI driver.
- **USB transfer time-out**
Set the time-out value for Control, Bulk, and Interrupt transfers.
- **Device reset time-out**
Set USB mass storage device Start Unit command time-out value.
- **Device power-up delay**
Set the maximum time of the device will take before it properly reports itself to the Host Controller. 'Auto' uses default value: for a Root port it is 100 ms, for a Hub port the delay is taken from Hub descriptor.

5.2.2.12 Embedded Controller Configuration



Figure 5.15 Embedded Controller Configuration

- **EC iManager WatchDog IRQ**
This item allows users to set the IRQ number of EC watchdog.
- **EC Power Saving Mode**
This item allows users to set board's power saving mode when off.
- **Backlight Mode**
This item allows users to set backlight Function.
- **EC Watchdog Function**
This item allows users to select EC watchdog timer.

5.2.2.13 Super IO Configuration

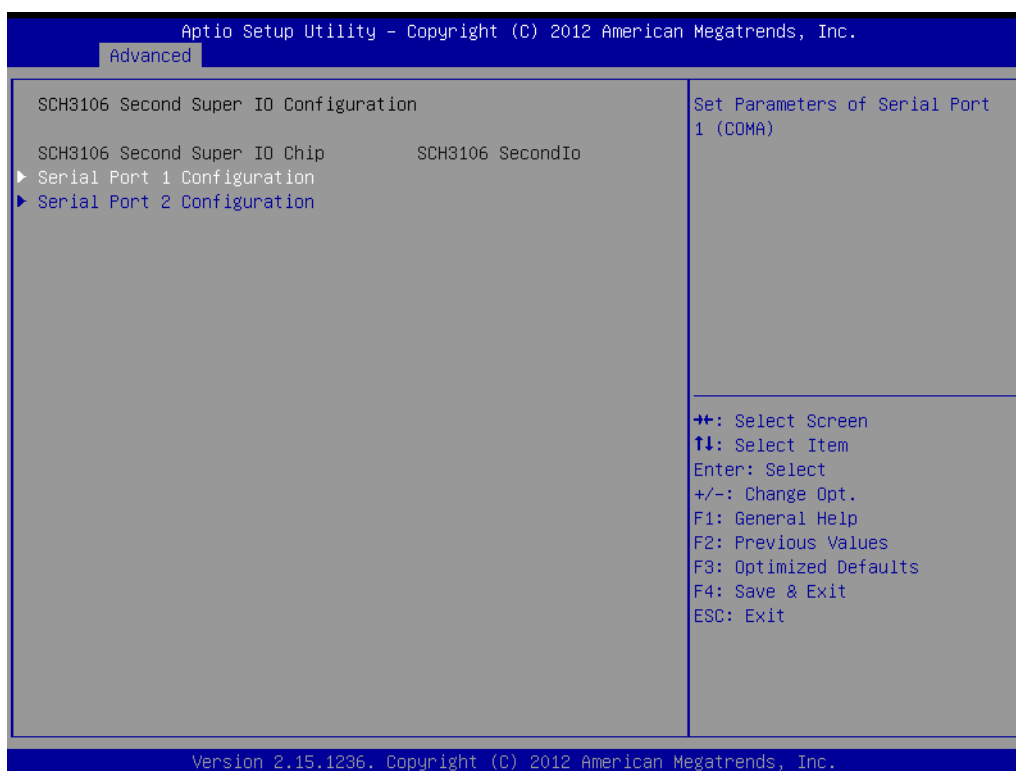
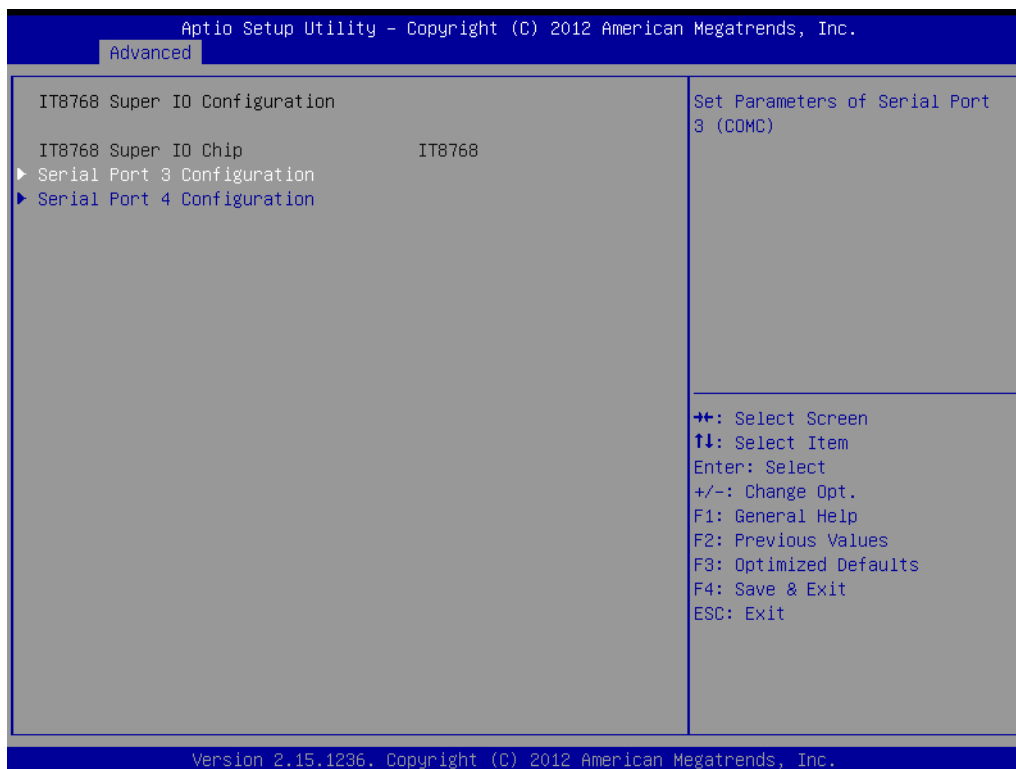

Figure 5.16 Super IO Configuration

- **Serial Port 1 Configuration**
This item allows users to configure serial port 1.
- **Serial Port 2 Configuration**
This item allows users to configure serial port 2.

- **Serial Port 3 Configuration**
This item allows users to configure serial port 3.
- **Serial Port 4 Configuration**
This item allows users to configure serial port 4.

5.2.2.14 Serial Port Console Redirection

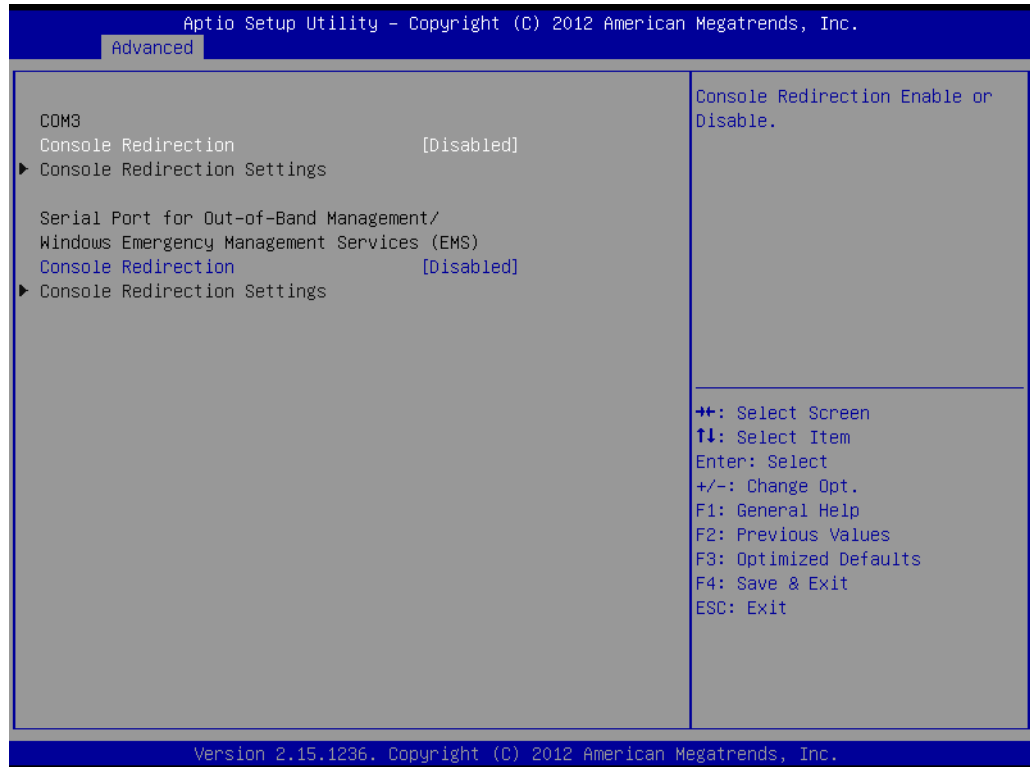

Figure 5.17 Serial Port Console Redirection

- **Console Redirection**
This item allows users to enable or disable console redirection for Microsoft Windows Emergency Management Services (EMS).
- **Console Redirection**
This item allows users to configuration console redirection detail settings.

5.2.3 Chipset

Select the Chipset tab from the ARK-2151V setup screen to enter the Chipset BIOS Setup screen. You can display a Chipset BIOS Setup option by highlighting it using the <Arrow> keys. All Plug and Play BIOS Setup options are described in this section. The Plug and Play BIOS Setup screen is shown below.

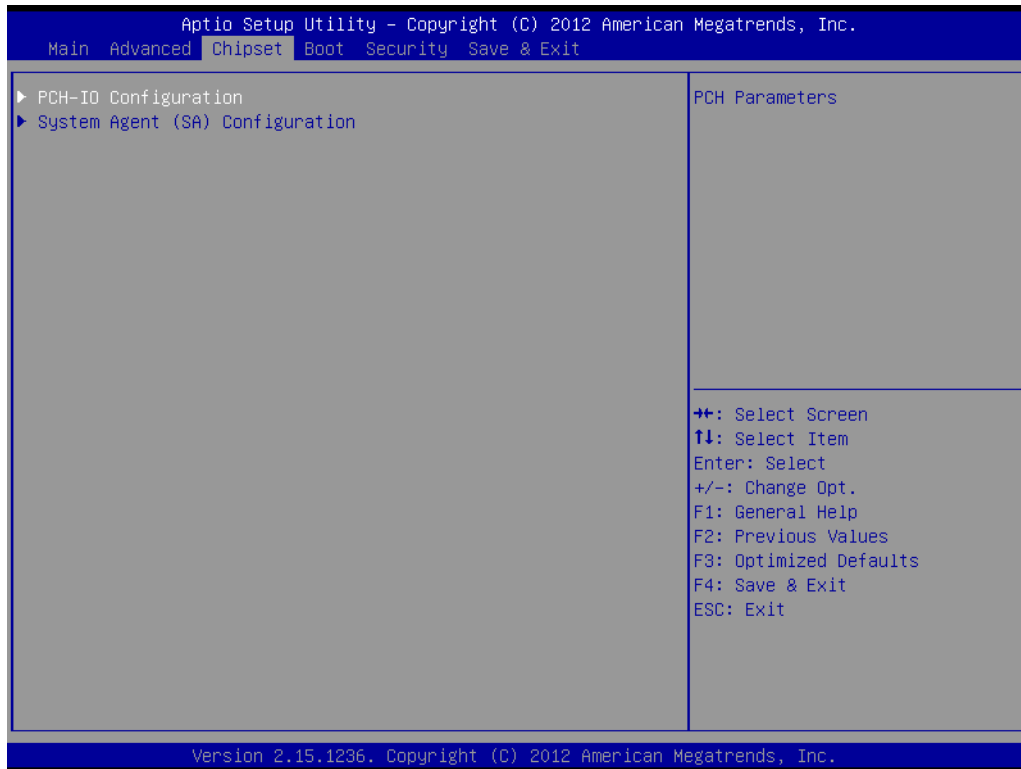

Figure 5.18 Chipset Setup

5.2.3.1 System Agent (SA) Configuration

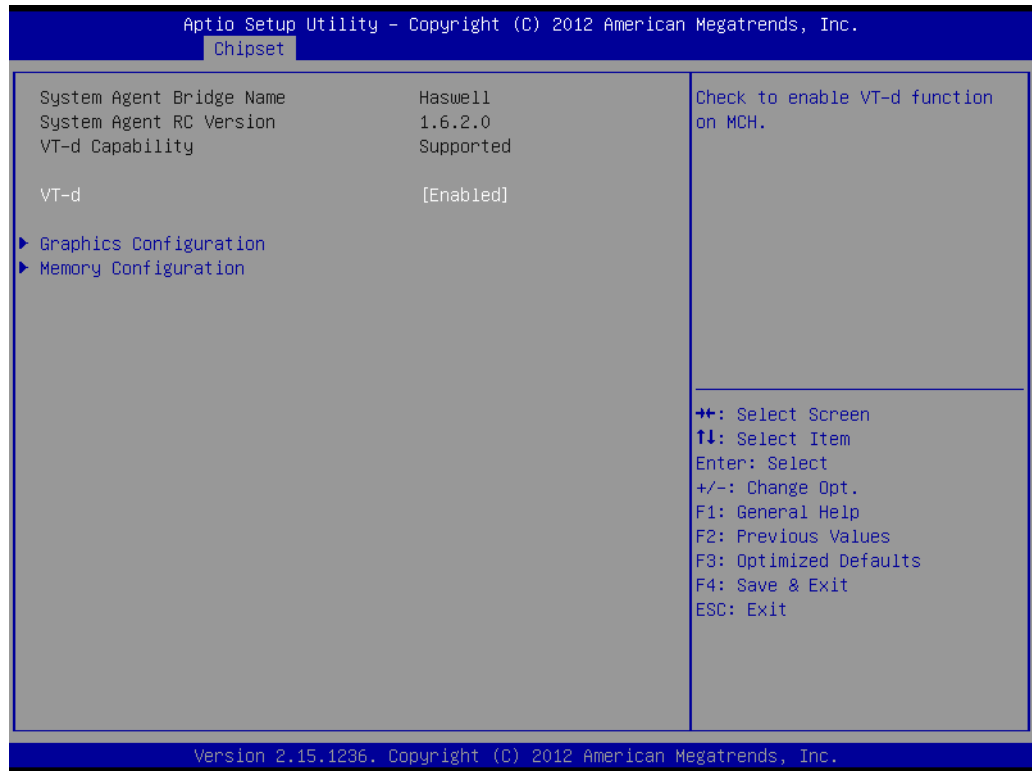

Figure 5.19 System Agent (SA) Configuration

- **VT-d**
This item allows users to enable or disable VT-d.

■ Intel IGFX Configuration

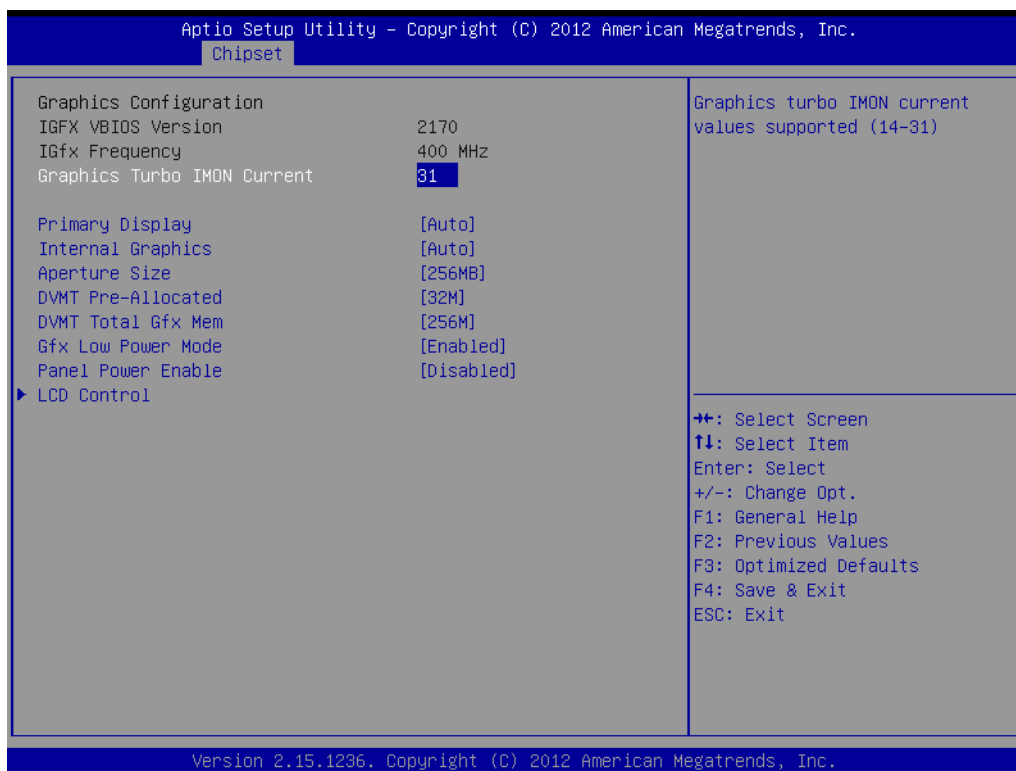

Figure 5.20 Intel IGFX Configuration

- **Graphics Turbo IMON Current**
This item allows users to select which Graphics Turbo IMON Current.
- **Primary Display**
This item allows users to select Primary Display.
- **Internal Graphics**
This item allows users to enable or disable IGD.
- **Aperture Size**
This item allows users to select aperture size.
- **DVMT Pre-Allocated**
This item allows users to select DVMT pre-allocated memory size.
- **DVMT Total Gfx Mem**
This item allows users to select DVMT total memory size.
- **Panel Power Enable**
This item allows users to enable or disable Panel Power. Graphics Performance.
- **Analyzers**
This item allows users to enable or disable Graphics Performance Analyzers.

– LCD Control

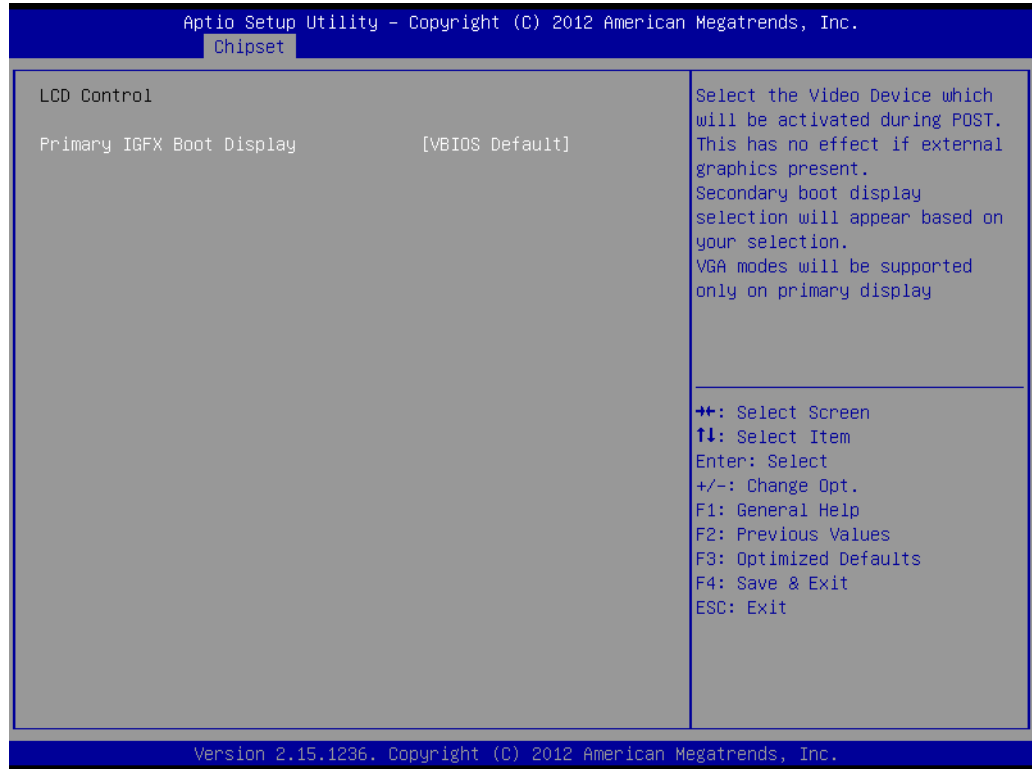

Figure 5.21 LCD Control

Primary IGFX Boot Display

Select boot display device at post stage.

LVDS

This item allows user to enable or disable LVDS.

LCD Panel Type

This item allows users to select panel resolution.

■ Memory Configuration

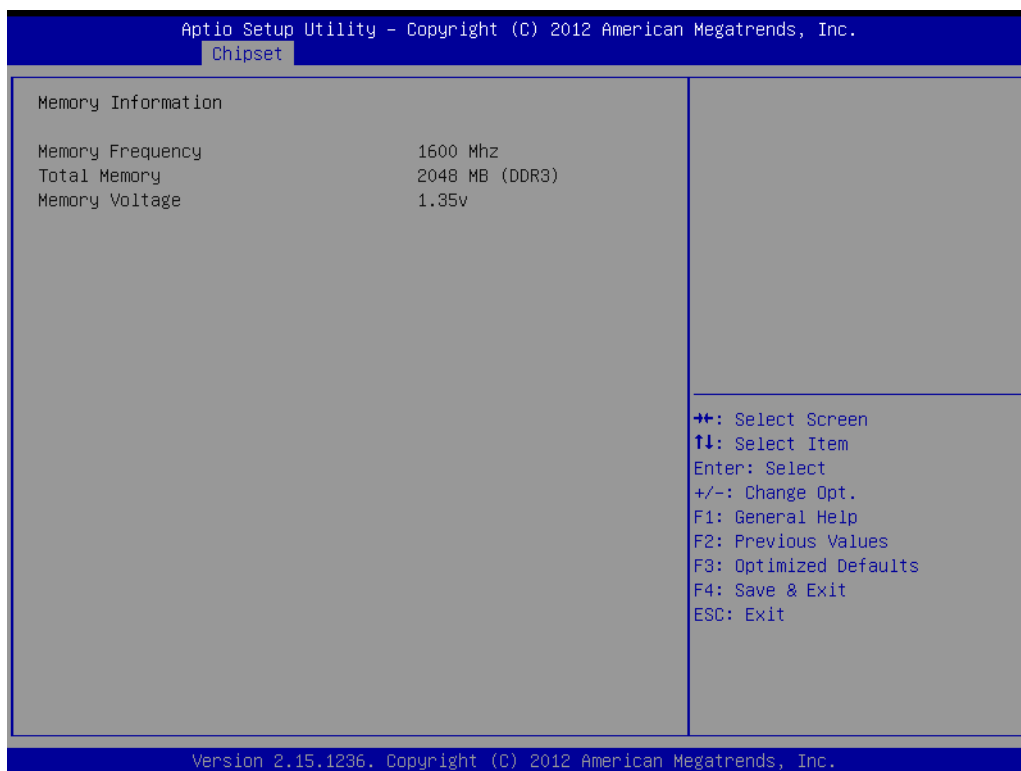

Figure 5.22 Memory Configuration

– Memory Information

This item shows memory configuration parameters.

5.2.3.2 PCH-IO Configuration

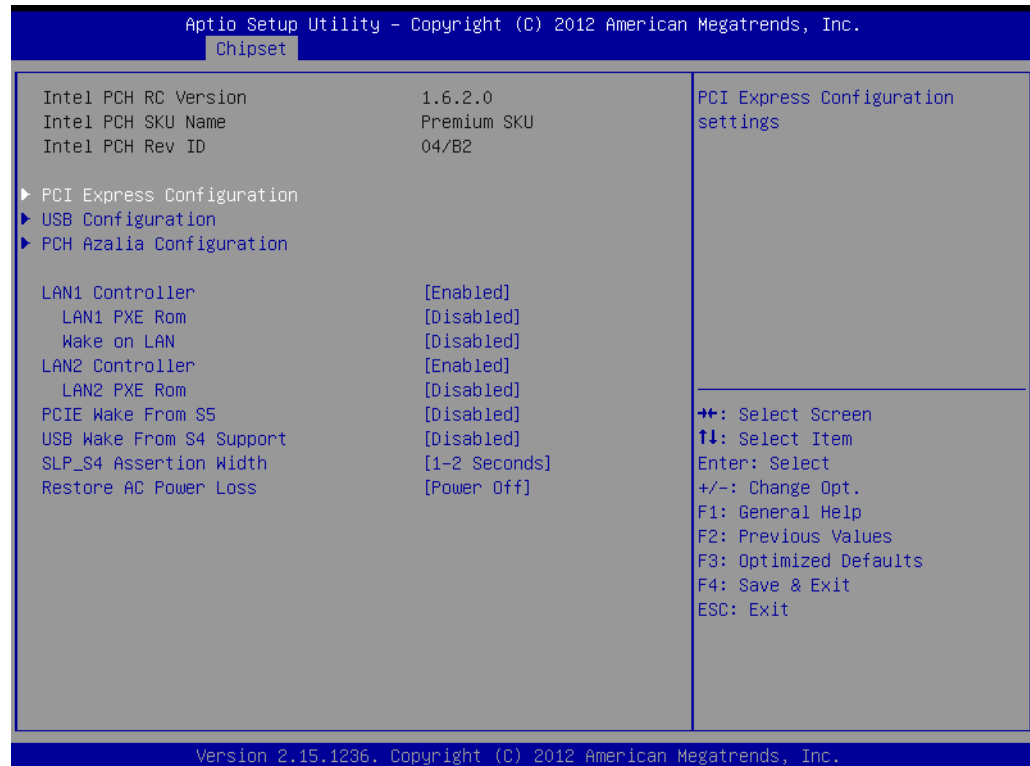

Figure 5.23 PCH-IO Configuration

- **PCI Express Clock Gating**
This item allows users to enable or disable PCI Express Clock Gating for each root port.
- **PCI Express Configuration**
This item allows users to configuration PCIE1~PCIE8 root port detail settings.
- **USB Configuration**
This item allows users to configuration detail of USB functions.
- **PCH Azalia Configuration**
This item allows users to configuration detail of azalia functions.
- **LAN 1/2 controller**
Enables or disables the LAN 1/2 controller.
- **Wake on LAN**
Enables or disables LAN1 wake up from sleep state.
- **LAN 1/2 PXE Rom**
This item allows users to enable or disable PXE Rom for LAN 1/2.
- **PCIE Wake from S5**
Enables or disables PCIE device wake up from S5.
- **USB Wake From S4 Support**
Enable or disable USB to wake the system from S4.
- **SLP_S4 Assertion Width**
This item allows users to set a delay of sorts.
- **Restore AC Power Loss**
This item allows users to select off, on and last state.

■ PCI Express Configuration

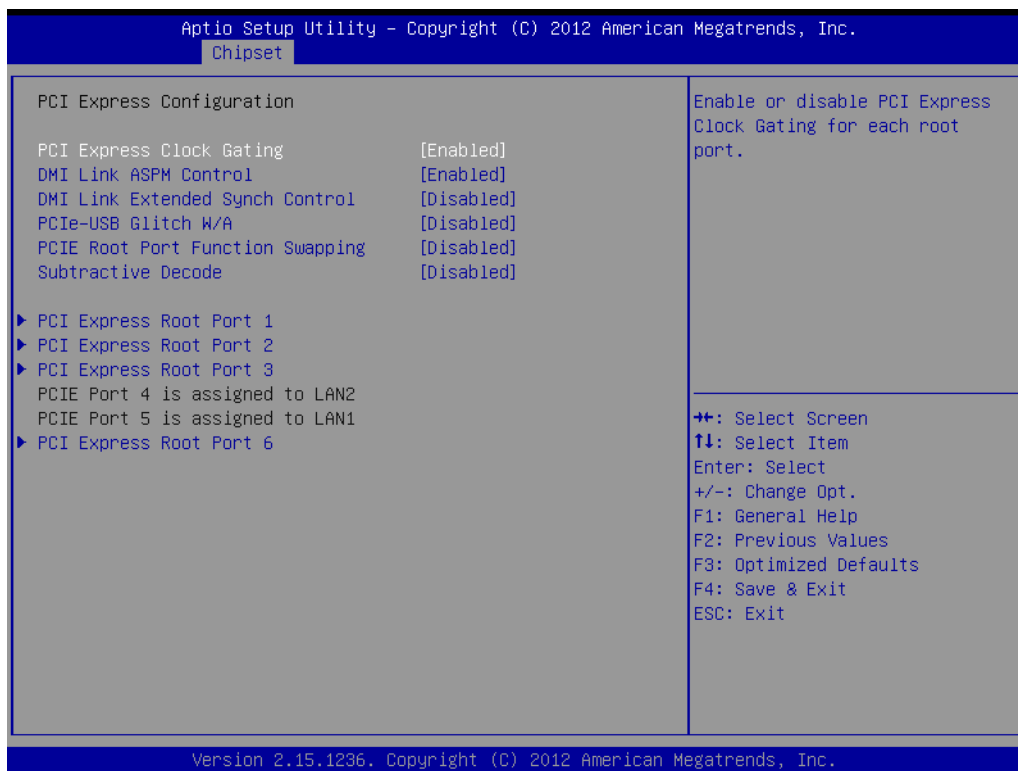

Figure 5.24 PCI Express Configuration

- **PCI Express Clock Gating**
This item allows users to enable or disable PCI Express Clock Gating for each root port.
- **DMI Link ASPM Control**
This item allows users to enable or disable the DMI Link ASPM Control.
- **DMI Link Extended Synch Control**
This item allows users to configure Mini PCI Express setting.
- **PCIe-USB Glitch W/A**
This item allows users to enable or disable PCIe-USB Glitch W/A. PCIe-USB Glitch W/A for bad USB device(s) connected behind PCIe/PEG Port.
- **Subtractive Decode**
This item allows users to enable or disable Subtractive Decode.
- **PCI Express Root Port 1/2/3/6**
This item allows users to configure PCI Express Root port 1/2/3/6 setting.

■ USB Configuration



Figure 5.25 USB Configuration

– **USB Precondition**

This item allows users to enable or disable USB Precondition. Precondition work on the USB host controller and root ports for faster enumeration.

– **XHCI Mode**

This item allows users to select mode of operation of XHCI mode.

– **XHCI Idle L1**

This item allows users to enable or disable XHCI Idle L1. XHCIIDLE L1 can be set to disable for LPT-LP Ax stepping to workaround USB3 hot plug will fail after 1 hot plug removal.

– **BTCG**

This item allows users to enable or disable trunk clock gating.

– **USB Ports Per-Port Disable Control**

This item allows users to enable or disable USB Ports Per-Port Disable Control. Control each of the USB ports (0~13) disabling.

■ PCH Azalia Configuration



Figure 5.26 PCH Azalia Configuration

- **Azalia**
This item allows users to change Azalia settings.
- **Control detection of the Azalia device**
 Disable- Azalia will be unconditionally Disabled.
 Enabled- Azalia will be unconditionally Enabled.
 Auto- Azalia will be enabled if present, disabled otherwise.

5.2.4 Boot Settings

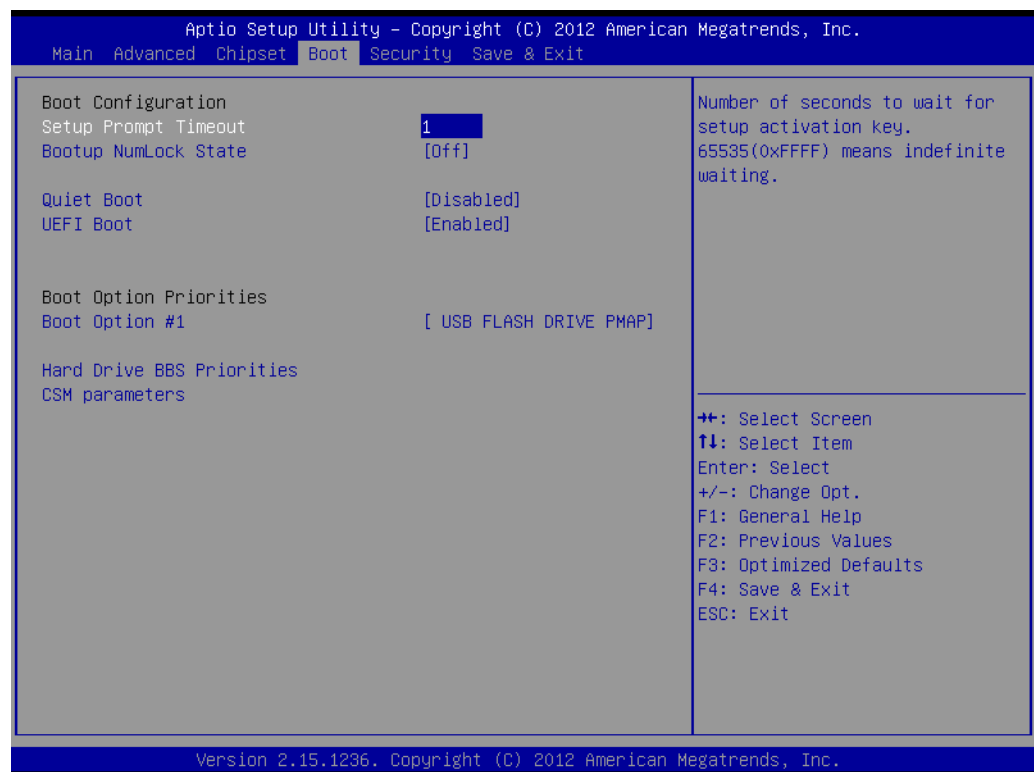

Figure 5.27 Boot Setup Utility

- **Setup Prompt Timeout**
This item allows users to select the number of seconds to wait for setup activation key.
- **Bootup NumLock State**
Select the Power-on state for Numlock.
- **Quiet Boot**
If this option is set to Disabled, the BIOS displays normal POST messages. If Enabled, an OEM Logo is shown instead of POST messages.
- **Boot Option #1**
This item allows users to set the system boot order.
- **Hard Drive BBS Priorities**
This item allows users to set the order of the legacy devices in this group.
- **CSM Support**
This item allows users to enable or disable CSM support.

5.2.5 Security Setup



Figure 5.28 Password Configuration

Select Security Setup from the MIO-5271 Setup main BIOS setup menu. All Security Setup options, such as password protection and virus protection are described in this section. To access the sub menu for the following items, select the item and press <Enter>:

Change Administrator / User Password: Select this option and press <ENTER> to access the sub menu, and then type in the password.

5.2.6 Save & Exit

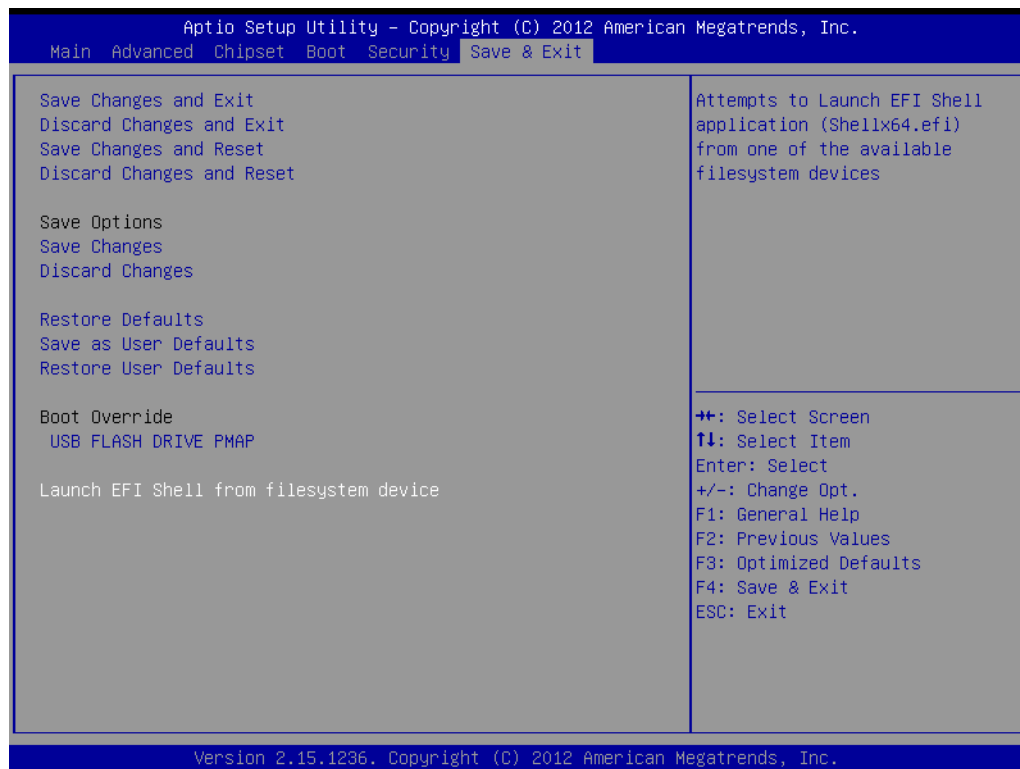

Figure 5.29 Save & Exit

- **Save Changes and Exit**

When users have completed system configuration, select this option to save changes, exit BIOS setup menu and reboot the computer if necessary to take effect of all system configuration parameters.
- **Discard Changes and Exit**

Select this option to quit Setup without making any permanent changes to the system configuration.
- **Save Changes and Reset**

When users have completed system configuration, select this option to save changes, exit BIOS setup menu and reboot the computer to take effect all system configuration parameters.
- **Discard Changes and Reset**

Select this option to quit Setup without making any permanent changes to the system configuration and reboot the computer.
- **Save Changes**

When users have completed system configuration, select this option to save changes without exit BIOS setup menu.
- **Discard Changes**

Select this option to discard any current changes and load previous system configuration.
- **Restore Defaults**

The ARK-2151V automatically configures all setup items to optimal settings when users select this option. Optimal Defaults are designed for maximum system performance, but may not work best for all computer applications. In particular, do not use the Optimal Defaults if the user's computer is experiencing system configuration problems.

- **Save as User Defaults**

When users have completed system configuration, select this option to save changes as user defaults without exit BIOS setup menu.

- **Restore User Defaults**

The users can select this option to restore user defaults.

- **Boot Override**

This item allows users to choose boot device.

Appendix **A**

WDT Sample Code

A.1 Watchdog Timer Sample Code

```
EC_Command_Port = 0x29Ah
EC_Data_Port = 0x299h
Write EC HW ram = 0x89
Watch dog event flag = 0x57
Watchdog reset delay time = 0x5E
Reset event = 0x04
Start WDT function = 0x28
=====
.model small
.486p
.stack 256
.data
.code
org 100h
.STARTup

mov dx, EC_Command_Port
mov al,89h ; Write EC HW ram.
out dx,al

mov dx, EC_Data_Port
mov al, 5Fh ; Watchdog reset delay time low byte (5Eh is high
byte) index.
out dx,al

mov dx, EC_Data_Port
mov al, 30h ;Set 3 seconds delay time.
out dx,al

mov dx, EC_Command_Port
mov al,89h ; Write EC HW ram.
out dx,al

mov dx, EC_ EC_Data_Port
mov al, 57h ; Watch dog event flag.
out dx,al

mov dx, EC_Data_Port
mov al, 04h ; Reset event.
out dx,al

mov dx, EC_Command_Port
mov al,28h ; start WDT function.
out dx,al
.exit
```

ADVANTECH

Enabling an Intelligent Planet

www.advantech.com

Please verify specifications before quoting. This guide is intended for reference purposes only.

All product specifications are subject to change without notice.

No part of this publication may be reproduced in any form or by any means, electronic, photocopying, recording or otherwise, without prior written permission of the publisher.

All brand and product names are trademarks or registered trademarks of their respective companies.

© Advantech Co., Ltd. 2015