

## HEIDI-RS

~8° spot beam

### SPECIFICATION:

Dimensions	Ø 21.6 mm
Height	11.7 mm
Fastening	tape, pin
ROHS compliant	yes ⓘ

### MATERIALS:

Component	Type	Material	Colour	Finish
HEIDI-RS	Single lens	PMMA	clear	
HEIDI-TAPE	Tape	Acrylic foam	black	

### ORDERING INFORMATION:

Component		Qty in box	MOQ	MPQ	Box weight (kg)
CA12537_HEIDI-RS	Single lens	3264	204	204	11.1
» Box size: 480 x 280 x 300 mm					



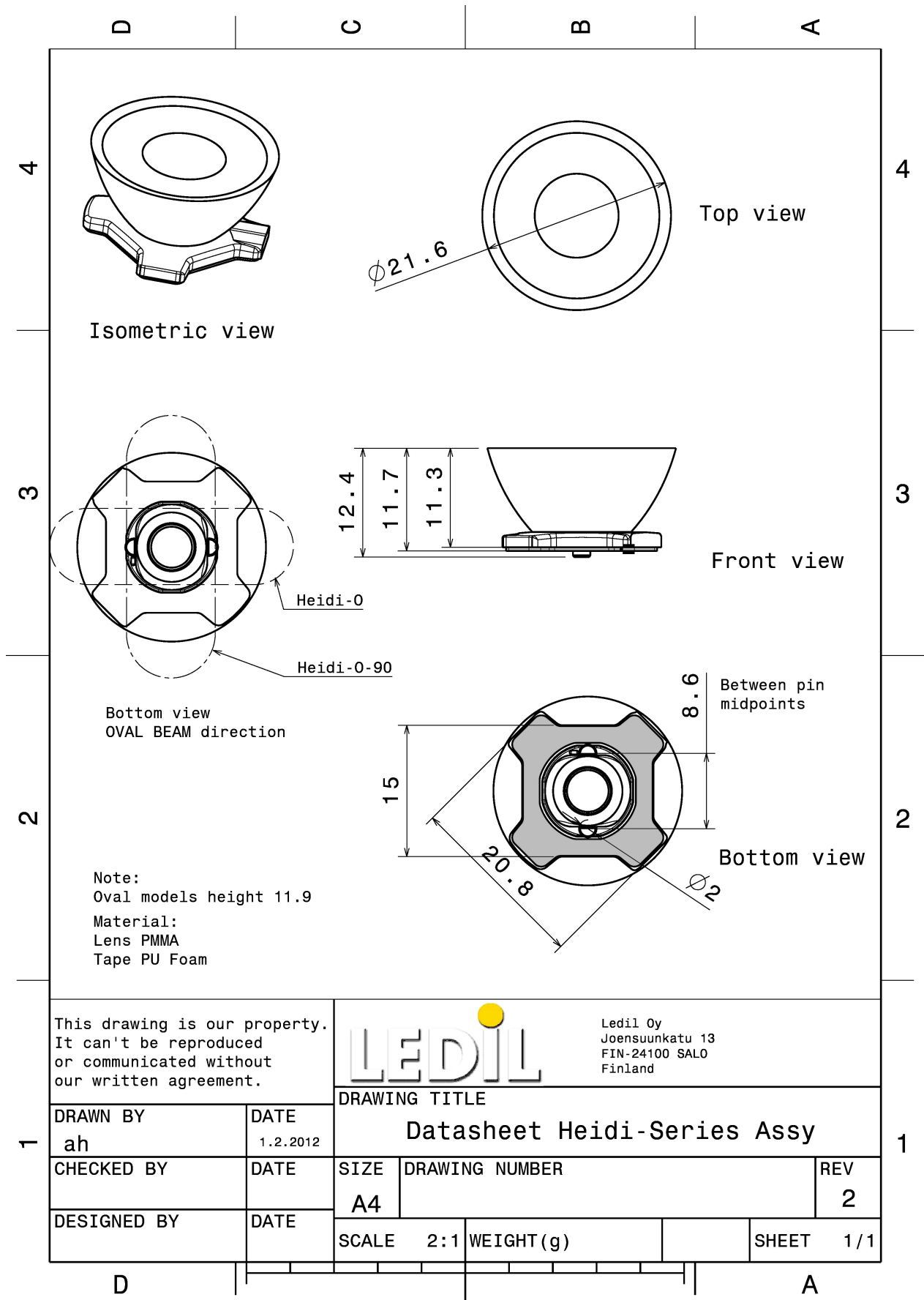

See also our general installation guide: [www.ledil.com/installation\\_guide](http://www.ledil.com/installation_guide)

### OPTICAL RESULTS (MEASURED):

#### CREE LED

LED XP-G2  
 FWHM / FWTM 10.0° / 18.0°  
 Efficiency 94 %  
 Peak intensity 20 cd/lm  
 LEDs/each optic 1  
 Light colour White  
 Required components:

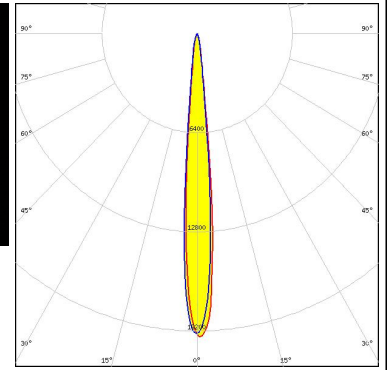

#### CREE LED

LED XP-G3  
 FWHM / FWTM 12.0° / 23.0°  
 Efficiency 94 %  
 Peak intensity 13 cd/lm  
 LEDs/each optic 1  
 Light colour White  
 Required components:

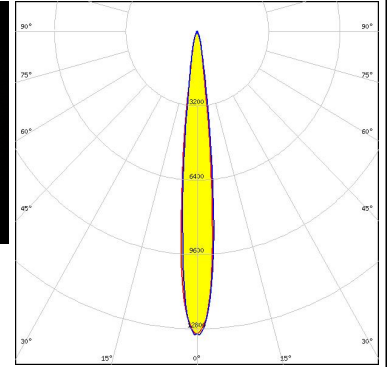

#### CREE LED

LED XP-L HD  
 FWHM / FWTM 15.0° / 29.0°  
 Efficiency 89 %  
 Peak intensity 8.3 cd/lm  
 LEDs/each optic 1  
 Light colour White  
 Required components:

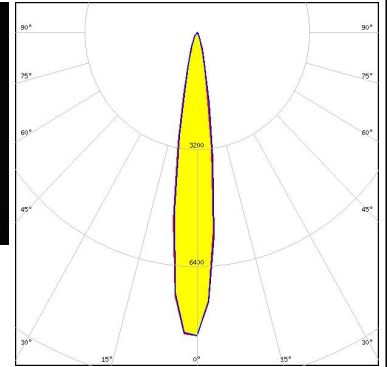

#### LUMILEDS

LED LUXEON A  
 FWHM / FWTM 11.0° / 20.0°  
 Efficiency 87 %  
 Peak intensity 15.6 cd/lm  
 LEDs/each optic 1  
 Light colour White  
 Required components:

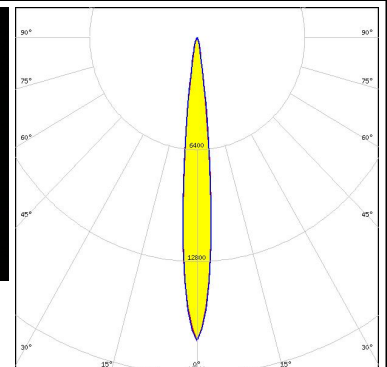

### OPTICAL RESULTS (MEASURED):

#### LUMILEDS

LED LUXEON Rebel  
 FWHM / FWTM 8.0° / 17.0°  
 Efficiency 88 %  
 Peak intensity 26 cd/lm  
 LEDs/each optic 1  
 Light colour White  
 Required components:



#### LUMILEDS

LED LUXEON Rebel ES  
 FWHM / FWTM 11.0° / 20.0°  
 Efficiency 86 %  
 Peak intensity 15.1 cd/lm  
 LEDs/each optic 1  
 Light colour White  
 Required components:

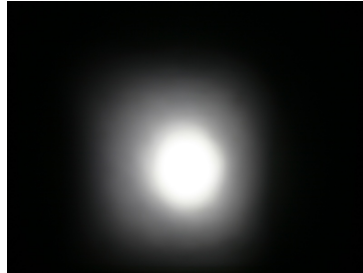

#### LUMINUS

LED SST-10-B130  
 FWHM / FWTM 8.0° / 16.0°  
 Efficiency 96 %  
 Peak intensity 27.9 cd/lm  
 LEDs/each optic 1  
 Light colour Blue  
 Required components:

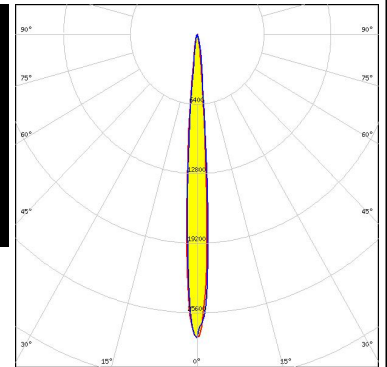
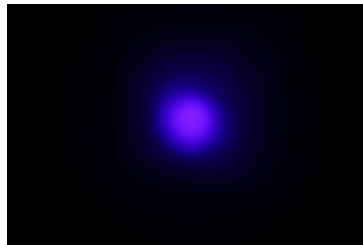





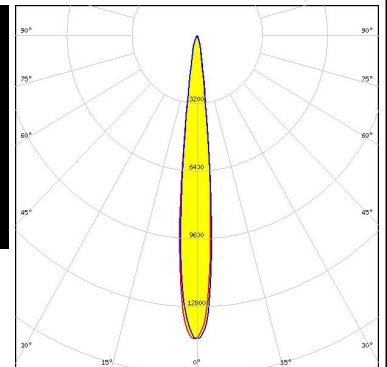

#### NICHIA

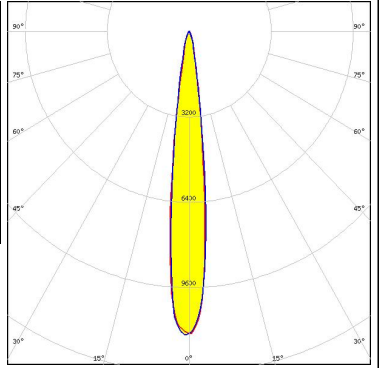
LED NVSW219D  
 FWHM / FWTM 11.0° / 21.0°  
 Efficiency 94 %  
 Peak intensity 14.3 cd/lm  
 LEDs/each optic 1  
 Light colour White  
 Required components:

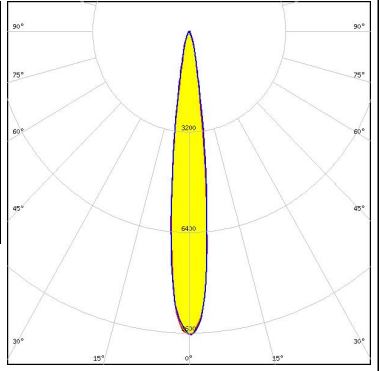

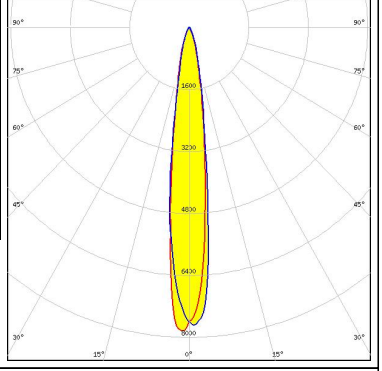
### OPTICAL RESULTS (MEASURED):

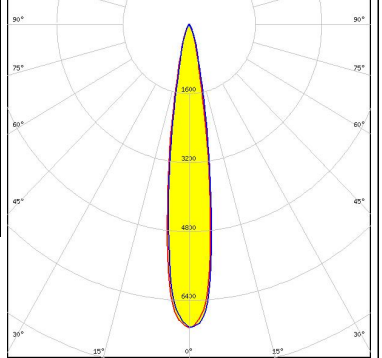
<p><b>NICHIA</b></p> <p>LED NVSW319B            FWHM / FWTM 13.0° / 25.0°            Efficiency 94 %            Peak intensity 11.4 cd/lm            LEDs/each optic 1            Light colour White            Required components:</p>		
<p><b>NICHIA</b></p> <p>LED NVSW3x9A            FWHM / FWTM 13.0° / 27.0°            Efficiency 92 %            Peak intensity 9.7 cd/lm            LEDs/each optic 1            Light colour White            Required components:</p>		
<p><b>NICHIA</b></p> <p>LED NVSW519A            FWHM / FWTM 14.0° / 33.0°            Efficiency 93 %            Peak intensity 8 cd/lm            LEDs/each optic 1            Light colour White            Required components:</p>		
<p><b>NICHIA</b></p> <p>LED NWSx229A            FWHM / FWTM 16.0° / 32.0°            Efficiency 87 %            Peak intensity 7 cd/lm            LEDs/each optic 1            Light colour White            Required components:</p>		

### OPTICAL RESULTS (MEASURED):

**OSRAM**  
Opto Semiconductors

LED OSLON SSL 150  
FWHM / FWTM 7.0° / 16.0°  
Efficiency 89 %  
Peak intensity 28.5 cd/lm  
LEDs/each optic 1  
Light colour White  
Required components:

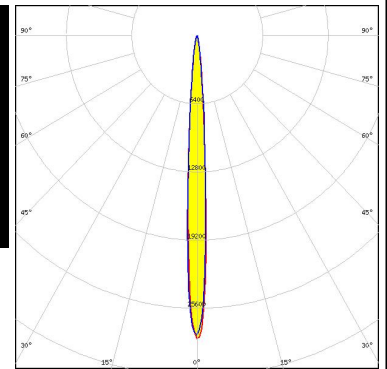

**OSRAM**  
Opto Semiconductors

LED PLPVEC2 850A  
FWHM / FWTM 6.0° / 16.0°  
Efficiency %  
LEDs/each optic 1  
Light colour IR  
Required components:

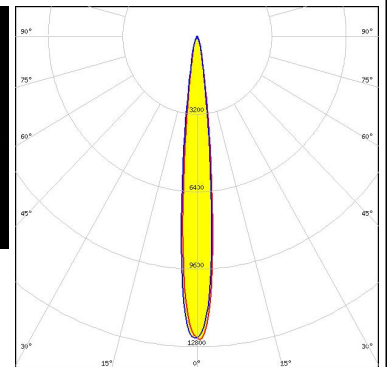

**SEOL**

SEOUL SEMICONDUCTOR

LED Z5M3  
FWHM / FWTM 11.0° / 23.0°  
Efficiency 94 %  
Peak intensity 12.5 cd/lm  
LEDs/each optic 1  
Light colour White  
Required components:

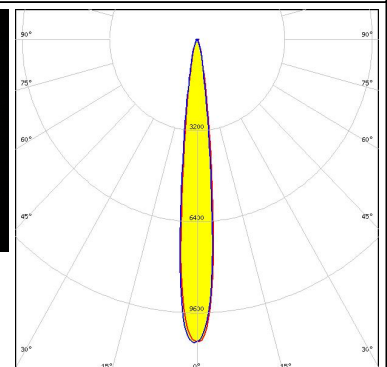
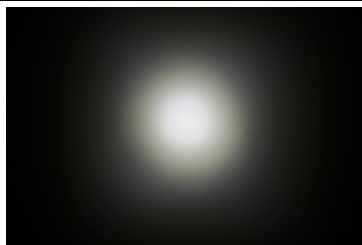

**SEOL**

SEOUL SEMICONDUCTOR

LED Z8Y22P  
FWHM / FWTM 12.0° / 25.0°  
Efficiency 94 %  
Peak intensity 10.7 cd/lm  
LEDs/each optic 1  
Light colour White  
Required components:



### OPTICAL RESULTS (SIMULATED):

<p><b>CREE</b> → <b>LED</b></p> <p>LED: XHP35 HD            FWHM / FWTM: 16.0° / 32.0°            Efficiency: 94 %            Peak intensity: 7.2 cd/lm            LEDs/each optic: 1            Light colour: White            Required components:</p>	
<p><b>CREE</b> → <b>LED</b></p> <p>LED: XHP35 HI            FWHM / FWTM: 12.0° / 22.0°            Efficiency: 96 %            Peak intensity: 14.2 cd/lm            LEDs/each optic: 1            Light colour: White            Required components:</p>	
<p><b>CREE</b> → <b>LED</b></p> <p>LED: XP-G2 HE            FWHM / FWTM: 12.0° / 26.0°            Efficiency: 95 %            Peak intensity: 12 cd/lm            LEDs/each optic: 1            Light colour: White            Required components:</p>	
<p><b>LUMILEDS</b></p> <p>LED: LUXEON CZ            FWHM / FWTM: 6.0° / 14.0°            Efficiency: 96 %            Peak intensity: 48.9 cd/lm            LEDs/each optic: 1            Light colour: White            Required components:</p>	

### OPTICAL RESULTS (SIMULATED):

#### LUMILEDS

LED LUXEON HL2X  
 FWHM / FWTM 14.0° / 26.0°  
 Efficiency 95 %  
 Peak intensity 11.6 cd/lm  
 LEDs/each optic 1  
 Light colour White  
 Required components:

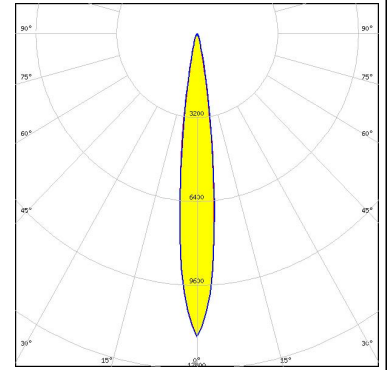

#### LUMILEDS

LED LUXEON HL2Z  
 FWHM / FWTM 10.0° / 20.0°  
 Efficiency 95 %  
 Peak intensity 19.4 cd/lm  
 LEDs/each optic 1  
 Light colour White  
 Required components:

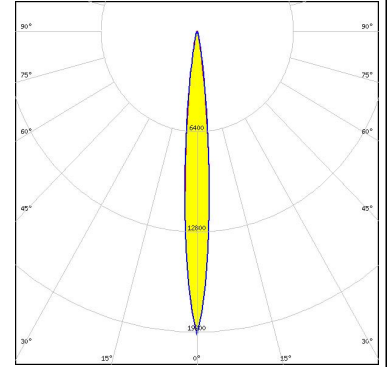

#### LUMILEDS

LED LUXEON IR Domed 150  
 FWHM / FWTM 11.0° / 22.0°  
 Efficiency 94 %  
 LEDs/each optic 1  
 Light colour White  
 Required components:

#### LUMILEDS

LED LUXEON IR Domed 90  
 FWHM / FWTM 11.0° / 23.0°  
 Efficiency 94 %  
 LEDs/each optic 1  
 Light colour White  
 Required components:



### OPTICAL RESULTS (SIMULATED):

#### LUMILEDS

LED LUXEON R  
 FWHM / FWTM 11.0° / 20.0°  
 Efficiency 92 %  
 Peak intensity 16.5 cd/lm  
 LEDs/each optic 1  
 Light colour White  
 Required components:

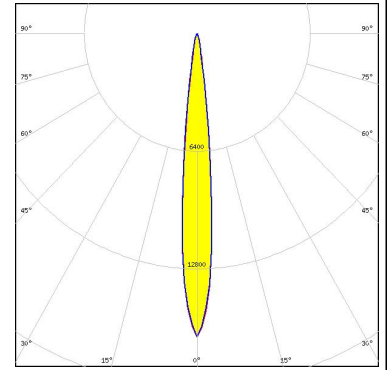

#### LUMILEDS

LED LUXEON SunPlus 20 Line (120 deg)  
 FWHM / FWTM 8.0° / 16.0°  
 Efficiency 96 %  
 Peak intensity 30.1 cd/lm  
 LEDs/each optic 1  
 Light colour White  
 Required components:

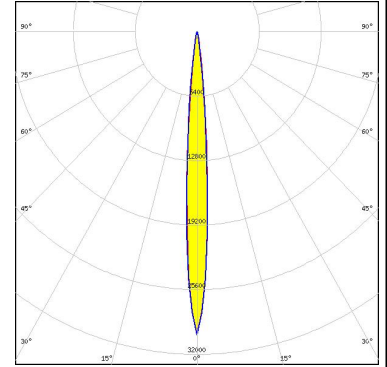

#### LUMILEDS

LED LUXEON SunPlus 20 Line (150 deg)  
 FWHM / FWTM 7.8° / 17.0°  
 Efficiency 93 %  
 Peak intensity 29.8 cd/lm  
 LEDs/each optic 1  
 Light colour White  
 Required components:

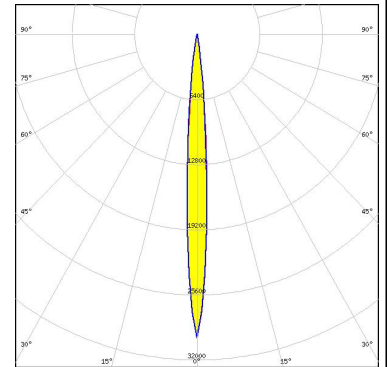

#### LUMILEDS

LED LUXEON SunPlus 20 Line (150 deg)  
 FWHM / FWTM 8.0° / 16.0°  
 Efficiency 92 %  
 Peak intensity 28.9 cd/lm  
 LEDs/each optic 1  
 Light colour White  
 Required components:

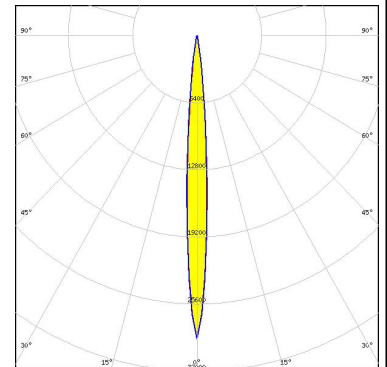

### OPTICAL RESULTS (SIMULATED):

<p><b>LUMILEDS</b></p> <p>LED: LUXEON SunPlus 35 Line</p> <p>FWHM / FWTM: 7.8° / 17.0°</p> <p>Efficiency: 94 %</p> <p>Peak intensity: 31.4 cd/lm</p> <p>LEDs/each optic: 1</p> <p>Light colour: White</p> <p>Required components:</p>	
<p><b>LUMILEDS</b></p> <p>LED: LUXEON TX</p> <p>FWHM / FWTM: 10.0° / 20.0°</p> <p>Efficiency: 96 %</p> <p>Peak intensity: 19.3 cd/lm</p> <p>LEDs/each optic: 1</p> <p>Light colour: White</p> <p>Required components:</p>	
<p><b>NICHIA</b></p> <p>LED: NV4WB35AM</p> <p>FWHM / FWTM: 16.0° / 30.0°</p> <p>Efficiency: 96 %</p> <p>Peak intensity: 8 cd/lm</p> <p>LEDs/each optic: 1</p> <p>Light colour: White</p> <p>Required components:</p>	
<p><b>NICHIA</b></p> <p>LED: NVSW719AC</p> <p>FWHM / FWTM: 12.0° / 20.0°</p> <p>Efficiency: 97 %</p> <p>Peak intensity: 19.2 cd/lm</p> <p>LEDs/each optic: 1</p> <p>Light colour: White</p> <p>Required components:</p>	

### OPTICAL RESULTS (SIMULATED):

<p><b>NICHIA</b></p> <p>LED NVSxE21A            FWHM / FWTM 10.0° / 20.0°            Efficiency 94 %            Peak intensity 19.4 cd/lm            LEDs/each optic 1            Light colour White            Required components:</p>	
<p><b>NICHIA</b></p> <p>LED NVSxx19B/NVSxx19C            FWHM / FWTM 12.0° / 22.0°            Efficiency 95 %            Peak intensity 15 cd/lm            LEDs/each optic 1            Light colour White            Required components:</p>	
<p><b>OSRAM</b>  <small>Opto Semiconductors</small></p> <p>LED OSCONIQ C 2424            FWHM / FWTM 8.0° / 18.0°            Efficiency 96 %            Peak intensity 26.6 cd/lm            LEDs/each optic 1            Light colour White            Required components:</p>	
<p><b>OSRAM</b>  <small>Opto Semiconductors</small></p> <p>LED OSCONIQ P 3737 Flat            FWHM / FWTM 10.0° / 22.0°            Efficiency 96 %            Peak intensity 16.5 cd/lm            LEDs/each optic 1            Light colour White            Required components:</p>	

### OPTICAL RESULTS (SIMULATED):

#### OSRAM

Opto Semiconductors

LED OSLON Black  
 FWHM / FWTM 11.0° / 22.0°  
 Efficiency 93 %  
 Peak intensity 16.8 cd/lm  
 LEDs/each optic 1  
 Light colour White  
 Required components:

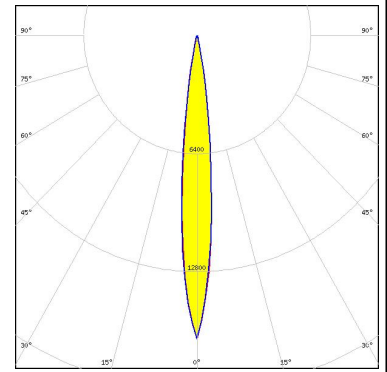

#### OSRAM

Opto Semiconductors

LED OSLON Black Flat  
 FWHM / FWTM 7.3° / 15.0°  
 Efficiency 94 %  
 Peak intensity 38.3 cd/lm  
 LEDs/each optic 1  
 Light colour White  
 Required components:

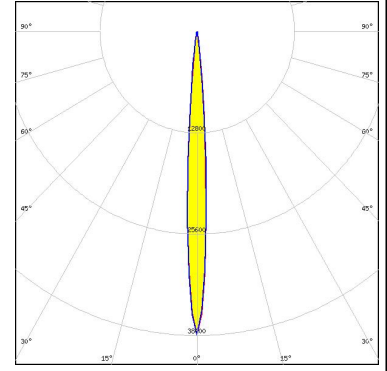

#### SAMSUNG

LED LH351D  
 FWHM / FWTM 16.0° / 29.0°  
 Efficiency 94 %  
 Peak intensity 8.2 cd/lm  
 LEDs/each optic 1  
 Light colour White  
 Required components:

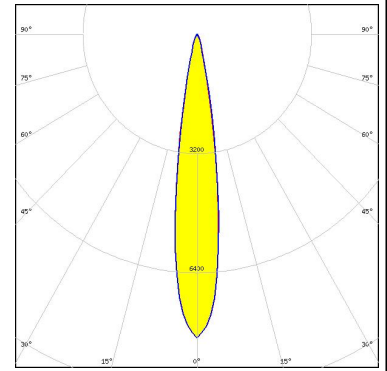

SEOUL SEMICONDUCTOR

LED Z5M4  
 FWHM / FWTM 12.0° / 25.0°  
 Efficiency 96 %  
 Peak intensity 13 cd/lm  
 LEDs/each optic 1  
 Light colour White  
 Required components:

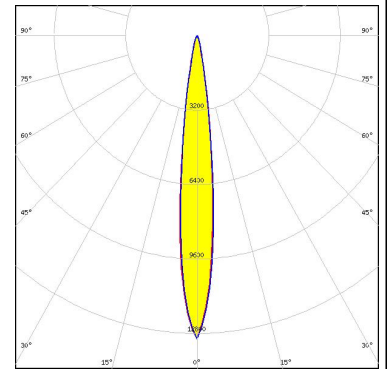

### GENERAL INFORMATION:

NOTE: The typical beam angle will be changed by different color, chip size and chip position tolerance. The typical total beam angle is the full angle measured where the luminous intensity is half of the peak value.

### MATERIALS:

As part of our continuous research and improvement processes, and to ensure the best possible quality and availability of our products, LEDiL reserves the right to change material grades without notice.

### PRODUCT DATA USER AGREEMENT AND DISCLAIMER:

The measured data in the provided downloadable LEDiL Product Datasheets and Mechanical 2D-Drawings is rounded and provided as reference for planning. LEDiL Oy's optical specifications have been verified by conducting performance testing of the products in accordance with the company's quality system. The reported data are averaged results of multiple measurements with typical variation. LEDiL Oy reserves the right to without prior notification make changes and improvements to its products.

LEDiL Oy assumes neither warranty, nor guarantee nor any other liability of any kind for the contents and correctness of the provided data. The provided data has been generated with highest diligence but the provided data may in reality not represent the complete possible variation range of all intrinsic parameters. Therefore, in certain cases a deviation from the provided data could occur.

LEDiL Oy reserves the right to undertake technical changes of its products without further notification which could lead to changes in the provided data. LEDiL Oy assumes no liability of any kind for the possible deviation from any provided data or any other damage resulting from the usage of the provided data.

The user agrees to this disclaimer and user agreement with the download or usage of the provided files.

#### LEDiL Oy

Joensuunkatu 13  
FI-24240 SALO  
Finland

#### LEDiL Inc.

228 West Page Street  
Suite D  
Sycamore IL 60178  
USA

#### Ledil Optics Technology (Shenzhen) Co., Ltd.

# 405 , Block B  
Casic Motor Building  
Shenzhen 518057  
P.R.CHINA

#### Local sales and technical support

[www.ledil.com/  
where\\_to\\_buy](http://www.ledil.com/where_to_buy)

#### Shipping locations

Salo, Finland  
Hong Kong, China

#### Distribution Partners

[www.ledil.com/  
where\\_to\\_buy](http://www.ledil.com/where_to_buy)