

Normally – OFF Silicon Carbide Junction Transistor

V_{DS}	=	1200 V
$R_{DS(ON)}$	=	470 mΩ
$I_D @ T_c=150^\circ\text{C}$	=	3 A
$h_{FE} T_c=25^\circ\text{C}$	=	54

Features

- 175 °C Maximum Operating Temperature
- Gate Oxide Free SiC Switch
- Exceptional Safe Operating Area
- Excellent Gain Linearity
- Temperature Independent Switching Performance
- Low Output Capacitance
- Positive Temperature Coefficient of $R_{DS,ON}$
- Suitable for Connecting an Anti-parallel Diode

Package

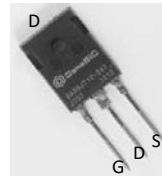
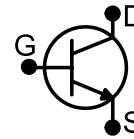
TO-247AB

Advantages

- Compatible with Si MOSFET/IGBT Gate Drive ICs
- > 20 μs Short-Circuit Withstand Capability
- Lowest-in-class Conduction Losses
- High Circuit Efficiency
- Minimal Input Signal Distortion
- High Amplifier Bandwidth

Applications

- Down Hole Oil Drilling, Geothermal Instrumentation
- Hybrid Electric Vehicles (HEV)
- Solar Inverters
- Switched-Mode Power Supply (SMPS)
- Power Factor Correction (PFC)
- Induction Heating
- Uninterruptible Power Supply (UPS)
- Motor Drives

Absolute Maximum Ratings

Parameter	Symbol	Conditions	Value	Unit	Notes
Drain – Source Voltage	V_{DS}	$V_{GS} = 0\text{ V}$	1200	V	Fig. 6
Continuous Drain Current	I_D	$T_c = 150^\circ\text{C}$	3	A	Fig. 19
Continuous Gate Current	I_{GM}		1	A	
Turn-Off Safe Operating Area	RBSOA	$T_{VJ} = 175^\circ\text{C}$, $I_G = 1\text{ A}$, Clamped Inductive Load	$I_{D,max} = 3$ @ $V_{DS} \leq V_{DSmax}$	A	Fig. 16
Short Circuit Safe Operating Area	SCSOA	$T_{VJ} = 175^\circ\text{C}$, $I_G = 1\text{ A}$, $V_{DS} = 800\text{ V}$, Non Repetitive	20	μs	
Reverse Gate – Source Voltage	V_{SG}		30	V	
Reverse Drain – Source Voltage	V_{SD}		25	V	
Power Dissipation	P_{tot}	$T_c = 150^\circ\text{C}$	15	W	Fig. 14
Storage Temperature	T_{stg}		-55 to 175	°C	

Electrical Characteristics

Parameter	Symbol	Conditions	Value			Unit	Notes
			Min.	Typical	Max.		
On State Characteristics							
Drain – Source On Resistance	$R_{DS(ON)}$	$I_D = 3\text{ A}$, $T_j = 25^\circ\text{C}$	470			mΩ	Fig. 5
		$I_D = 3\text{ A}$, $T_j = 125^\circ\text{C}$	530				
		$I_D = 3\text{ A}$, $T_j = 175^\circ\text{C}$	730				
Gate Forward Voltage	$V_{GS(FWD)}$	$I_G = 500\text{ mA}$, $T_j = 25^\circ\text{C}$	3.3			V	Fig. 4
		$I_G = 500\text{ mA}$, $T_j = 175^\circ\text{C}$	3.1				
DC Current Gain	h_{FE}	$V_{DS} = 5\text{ V}$, $I_D = 3\text{ A}$, $T_j = 25^\circ\text{C}$	54			–	Fig. 5
		$V_{DS} = 5\text{ V}$, $I_D = 3\text{ A}$, $T_j = 175^\circ\text{C}$	32				
Off State Characteristics							
Drain Leakage Current	I_{DSS}	$V_R = 1200\text{ V}$, $V_{GS} = 0\text{ V}$, $T_j = 25^\circ\text{C}$	0.1			μA	Fig. 6
		$V_R = 1200\text{ V}$, $V_{GS} = 0\text{ V}$, $T_j = 125^\circ\text{C}$	0.2				
		$V_R = 1200\text{ V}$, $V_{GS} = 0\text{ V}$, $T_j = 175^\circ\text{C}$	0.5				
Gate Leakage Current	I_{SG}	$V_{SG} = 20\text{ V}$, $T_j = 25^\circ\text{C}$	20			nA	

Electrical Characteristics

Parameter	Symbol	Conditions	Value			Unit	Notes
			Min.	Typical	Max.		
Capacitance Characteristics							
Input Capacitance	C_{iss}	$V_{GS} = 0\text{ V}, V_D = 800\text{ V}, f = 1\text{ MHz}$		315		pF	Fig. 7
Reverse Transfer/Output Capacitance	C_{rss}/C_{oss}	$V_D = 800\text{ V}, f = 1\text{ MHz}$		15		pF	Fig. 7
Output Capacitance Stored Energy	E_{OSS}	$V_{GS} = 0\text{ V}, V_D = 1000\text{ V}, f = 1\text{ MHz}$		6.1		μJ	Fig. 8
Switching Characteristics¹							
Internal Gate Resistance, Zero Bias	$R_{G(INT-ZERO)}$	$f = 1\text{ MHz}, V_{AC} = 25\text{ mV}, T_J = 175\text{ °C}$		18.0		Ω	
Internal Gate Resistance, On	$R_{G(INT-ON)}$	$V_{GS} > 2.5\text{ V}$		0.9		Ω	
Turn On Delay Time	$t_{d(on)}$	$T_J = 25\text{ °C}, V_{DS} = 800\text{ V}, I_D = 3\text{ A},$		17		ns	
Fall Time, V_{DS}	t_f	$R_{G(EXT)} = 40\text{ Ω}, C_G = 9\text{ nF},$		20		ns	Fig. 9, 11
Turn Off Delay Time	$t_{d(off)}$	$V_G = 25/-5\text{ V}, \text{Load} = 267\text{ Ω}$		29		ns	
Rise Time, V_{DS}	t_r	Refer to Fig. 20 for I_G Waveform		30		ns	Fig. 10, 12
Turn On Delay Time	$t_{d(on)}$	$T_J = 175\text{ °C}, V_{DS} = 800\text{ V}, I_D = 3\text{ A},$		14		ns	
Fall Time, V_{DS}	t_f	$R_{G(EXT)} = 40\text{ Ω}, C_G = 9\text{ nF},$		19		ns	Fig. 9
Turn Off Delay Time	$t_{d(off)}$	$V_G = 25/-5\text{ V}, \text{Load} = 267\text{ Ω}$		23		ns	
Rise Time, V_{DS}	t_r	Refer to Fig. 20 for I_G Waveform		33		ns	Fig. 10
Turn-On Energy Per Pulse	E_{on}	$T_J = 25\text{ °C}, V_{DS} = 800\text{ V}, I_D = 3\text{ A},$		84		μJ	Fig. 9, 11
Turn-Off Energy Per Pulse	E_{off}	$R_{G(EXT)} = 40\text{ Ω}, C_G = 9\text{ nF},$		9		μJ	Fig. 10, 12
Total Switching Energy	E_{tot}	$V_G = 25/-5\text{ V}, \text{Load} = 1.05\text{ mH}$		93		μJ	
Turn-On Energy Per Pulse	E_{on}	$T_J = 175\text{ °C}, V_{DS} = 800\text{ V}, I_D = 3\text{ A},$		79		μJ	Fig. 9
Turn-Off Energy Per Pulse	E_{off}	$R_{G(EXT)} = 40\text{ Ω}, C_G = 9\text{ nF},$		10		μJ	Fig. 10
Total Switching Energy	E_{tot}	$V_G = 25/-5\text{ V}, \text{Load} = 1.05\text{ mH}$		89		μJ	

¹ – All times are relative to the Drain-Source Voltage V_{DS}
Thermal Characteristics

Thermal resistance, junction - case	R_{thJC}		1.64	°C/W	Fig. 17
-------------------------------------	------------	--	------	------	---------

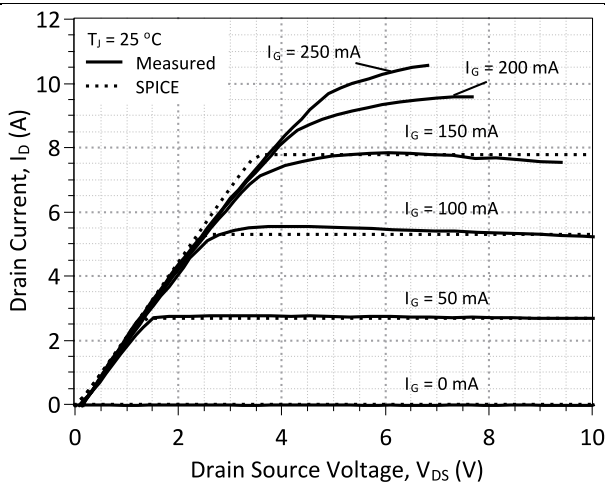
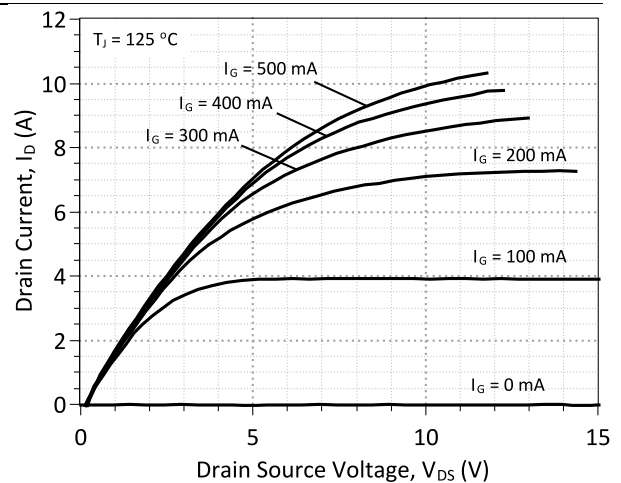
Figures

Figure 1: Typical Output Characteristics at 25 °C

Figure 2: Typical Output Characteristics at 125 °C

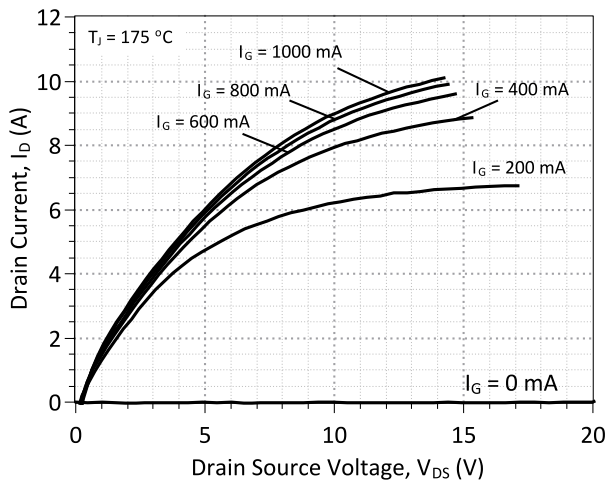

Figure 3: Typical Output Characteristics at 175 °C

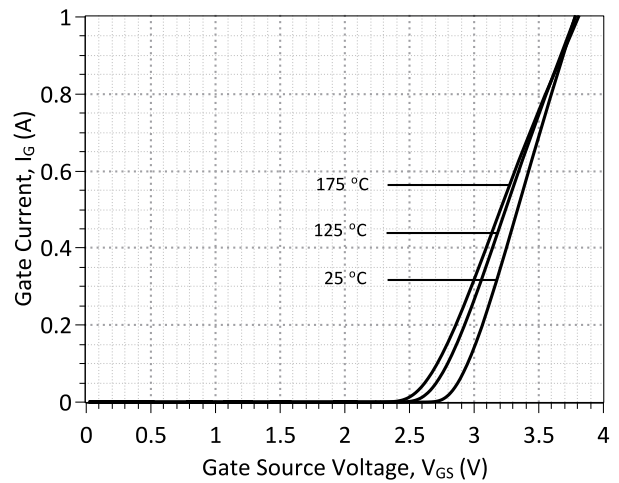

Figure 4: Typical Gate Source I-V Characteristics vs. Temperature

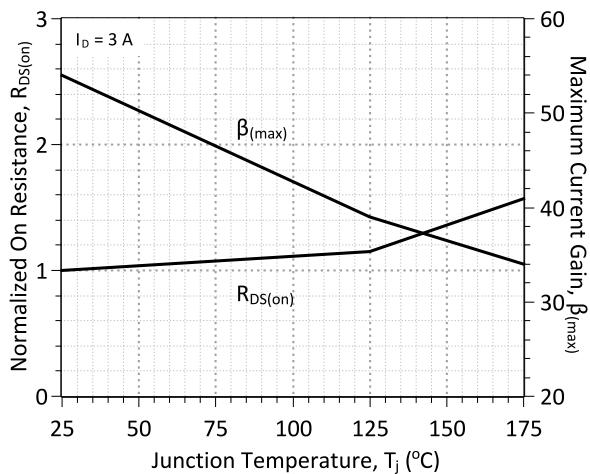

Figure 5: Normalized On-Resistance and Current Gain vs. Temperature

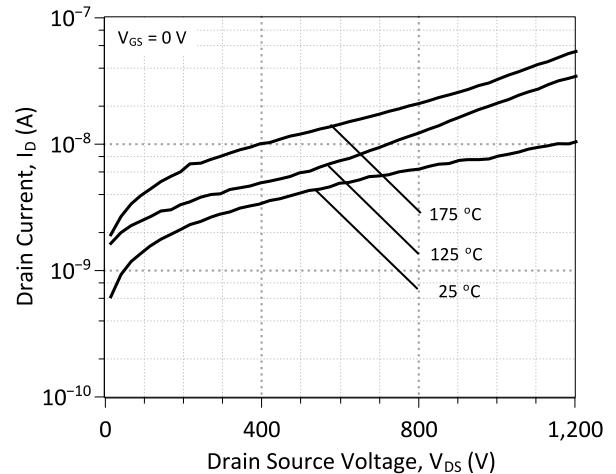

Figure 6: Typical Blocking Characteristics

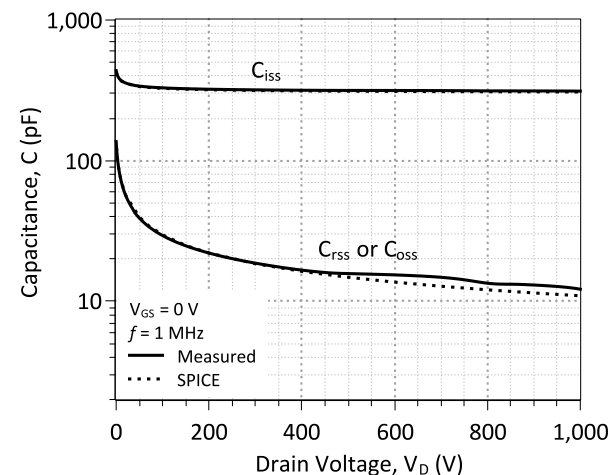

Figure 7: Input, Output, and Reverse Transfer Capacitance

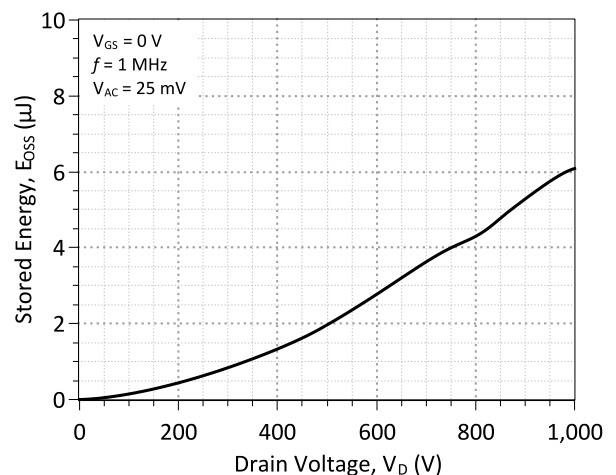

Figure 8: Output Capacitance Stored Energy

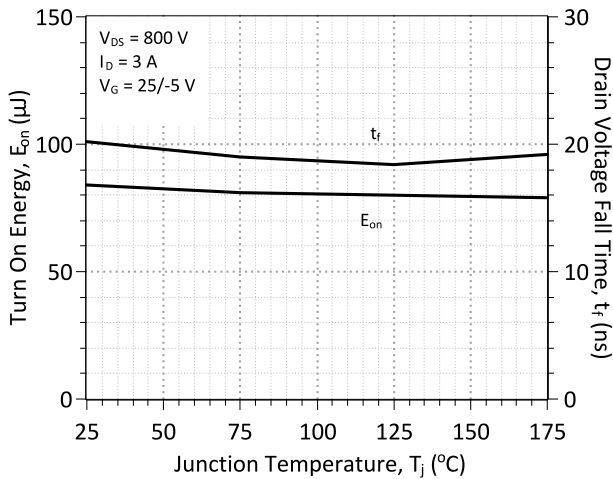

Figure 9: Typical Turn On Energy Losses and Switching Times vs. Temperature

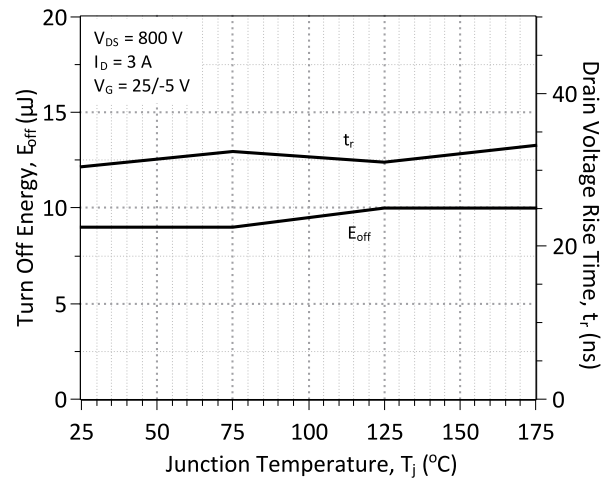

Figure 10: Typical Turn Off Energy Losses and Switching Times vs. Temperature

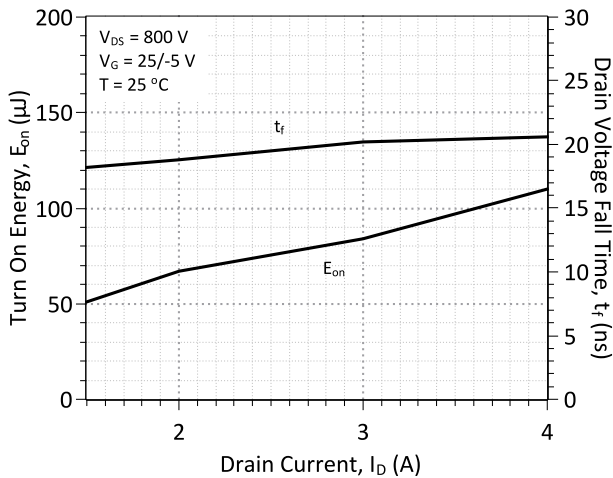

Figure 11: Typical Turn On Energy Losses and Switching Times vs. Drain Current

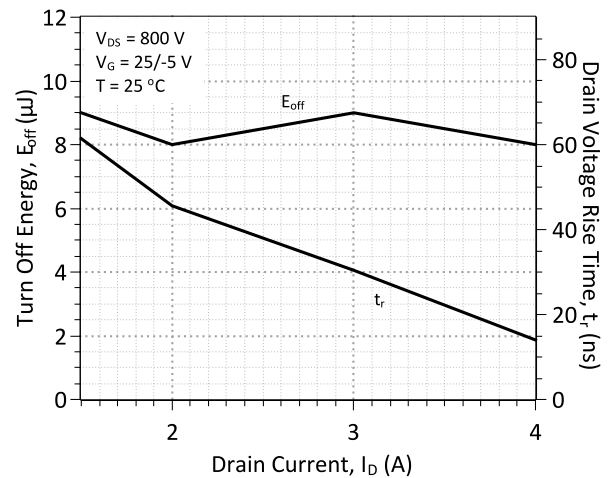

Figure 12: Typical Turn Off Energy Losses and Switching Times vs. Drain Current

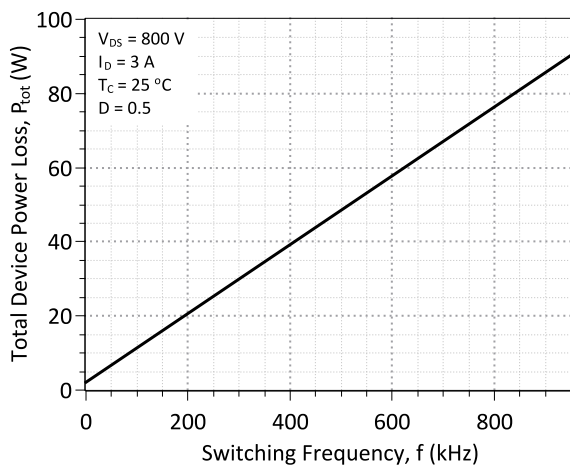

Figure 13: Typical Hard Switched Device Power Loss vs. Switching Frequency²

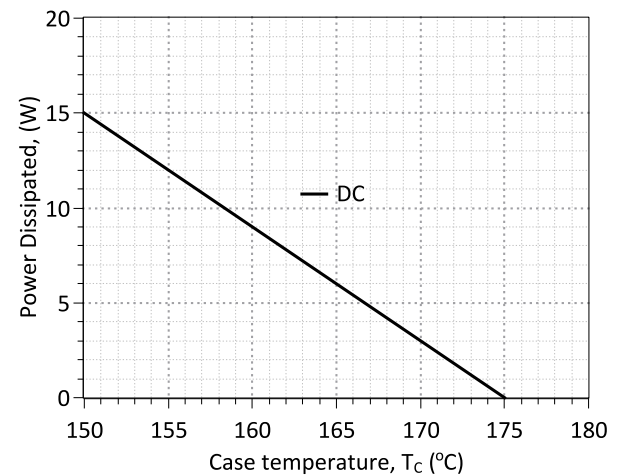

Figure 14: Power Derating Curve

² – Representative values based on device switching energy loss. Actual losses will depend on gate drive conditions, device load, and circuit topology.

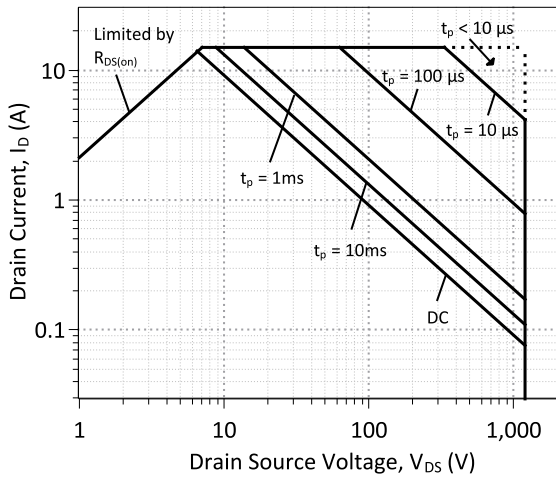

Figure 15: Forward Bias Safe Operating Area at $T_c = 25\text{ }^\circ\text{C}$

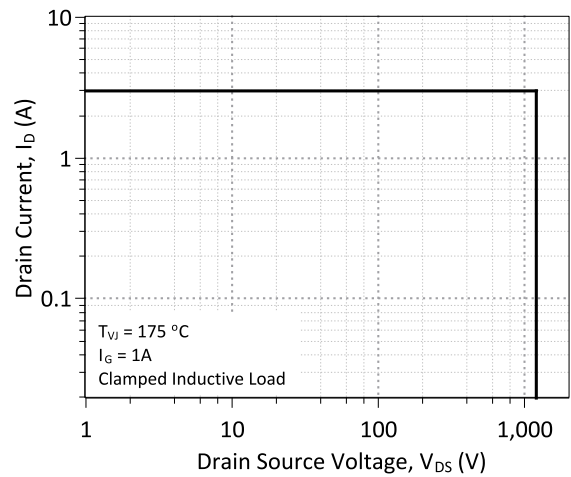

Figure 16: Turn-Off Safe Operating Area

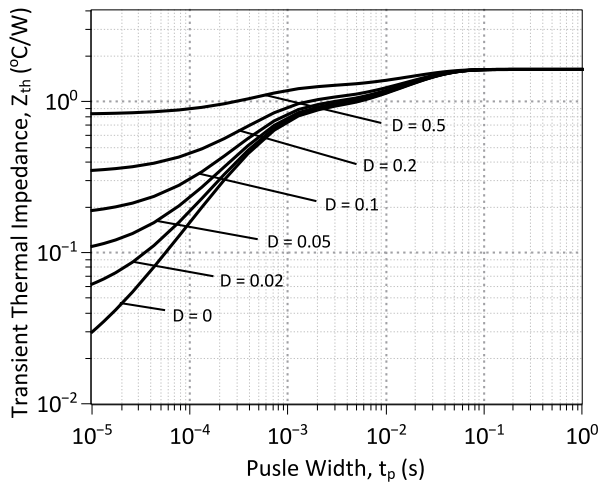

Figure 17: Transient Thermal Impedance

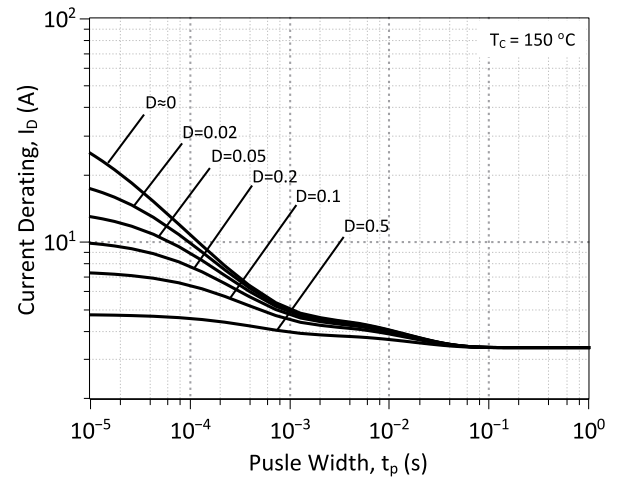

Figure 18: Drain Current Derating vs. Pulse Width

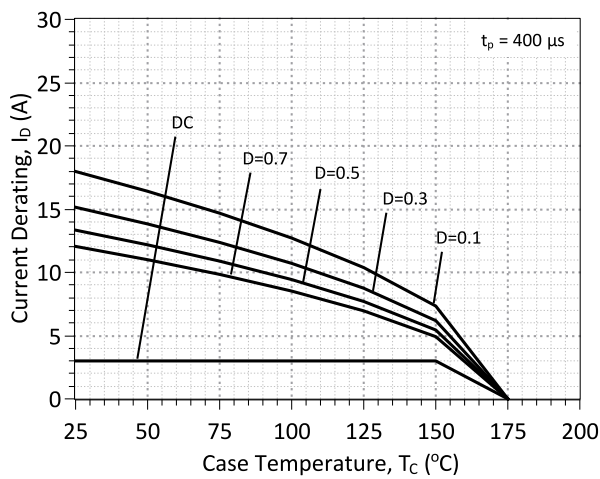

Figure 19: Drain Current Derating vs. Temperature

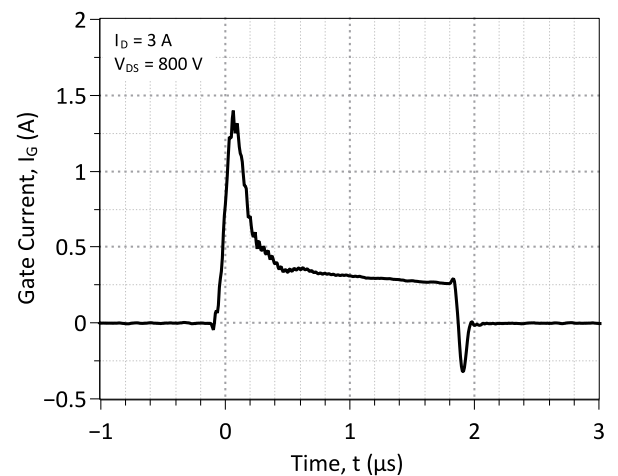

Figure 20: Typical Gate Current Waveform

Driving the GA03JT12-247
A: Gate Drive Theory of Operation

The SJT is a current controlled transistor which requires a positive gate current for turn-on as well as to remain in on-state. An ideal gate current waveform for ultra-fast switching of the SJT, while maintaining low gate drive losses, is shown in Figure 21.

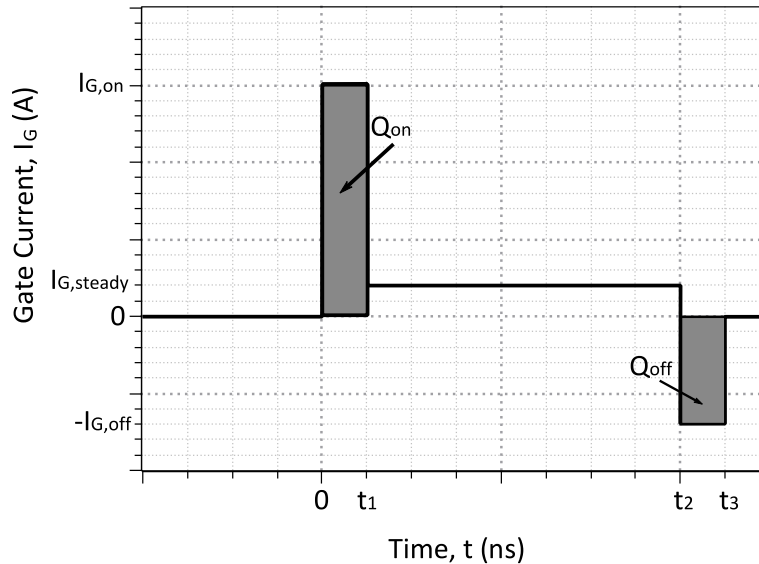

Figure 21: Idealized Gate Current Waveform

A:1: Gate Currents, $I_{G,pk}/I_{G,pk}$ and Voltages during Turn-On and Turn-Off

An SJT is rapidly switched from its blocking state to on-state, when the necessary gate charge, Q_G , for turn-on is supplied by a burst of high gate current, $I_{G,on}$, until the gate-source capacitance, C_{GS} , and gate-drain capacitance, C_{GD} , are fully charged.

$$I_{G,on} * t_1 \geq Q_{gs} + Q_{gd}$$

The $I_{G,on}$ pulse should ideally terminate, when the drain voltage falls to its on-state value, in order to avoid unnecessary drive losses during the steady on-state. In practice, the rise time of the $I_{G,on}$ pulse is affected by the parasitic inductances, L_{par} in the TO-247 package and drive circuit. A voltage developed across the parasitic inductance in the source path, L_s , can de-bias the gate-source junction, when high drain currents begin to flow through the device. The applied gate voltage should be maintained high enough, above the $V_{GS,ON}$ level to counter these effects.

A high negative peak current, $-I_{G,off}$ is recommended at the start of the turn-off transition, in order to rapidly sweep out the injected carriers from the gate, and achieve rapid turn-off. While satisfactory turn off can be achieved with $V_{GS} = 0$ V, a negative gate voltage V_{GS} may be used in order to speed up the turn-off transition.

A:2: Steady On-State

After the device is turned on, I_G may be advantageously lowered to $I_{G,steady}$ for reducing unnecessary gate drive losses. The $I_{G,steady}$ is determined by noting the DC current gain, h_{FE} , of the device.

The desired $I_{G,steady}$ is determined by the peak device junction temperature T_J during operation, drain current I_D , DC current gain h_{FE} , and a 50 % safety margin to ensure operating the device in the saturation region with low on-state voltage drop by the equation:

$$I_{G,steady} \approx \frac{I_D}{h_{FE}(T, I_D)} * 1.5$$

B: Gate Drive Implementation Examples
B:1: Using the IXYS IX2204 Gate Driver

The IXYS IX2204 is a dual output gate drive integrated circuit which can be used to drive an SJT by supplying the required gate drive current $I_{G,on}$ in a low-power gate drive solution. This configuration features an external gate capacitor, C_G , which creates the brief current peak $I_{G,on}$ during device turn-on and $I_{G,off}$ during turn-off for fast switching and an external gate resistor $R_{G(EXT)}$ to set the continuous gate current $I_{G,steady}$ required for the device to remain on. This configuration is shown in Figure 22 with further details provided below.

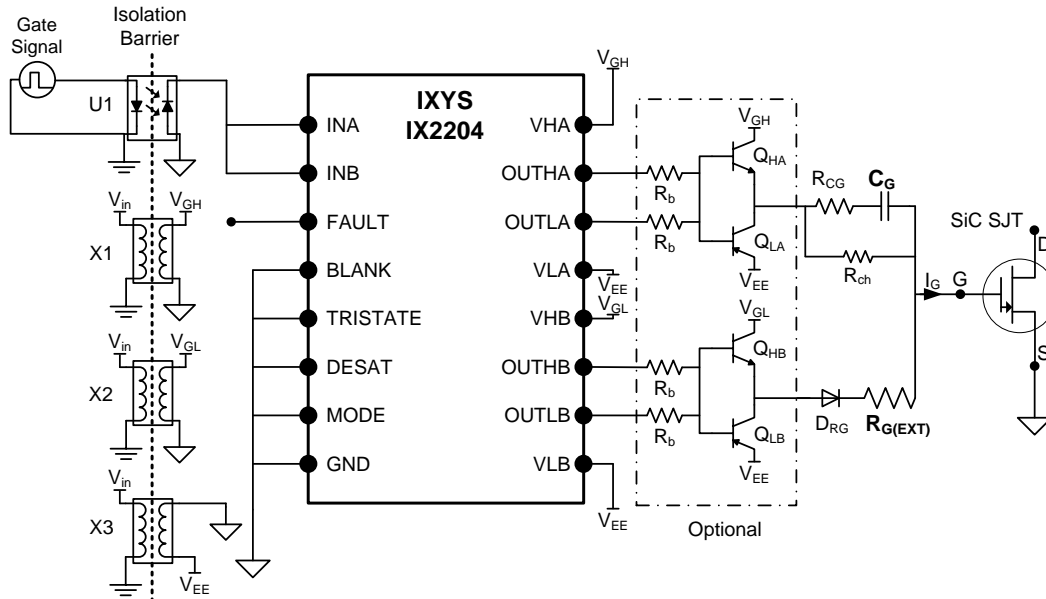

Figure 1: Gate drive configuration using an IXYS IX2204 gate drive IC.

Table 1: Recommended Component List for implementing the IX2204 based Gate Drive for the GA03JT12-247

Reference	Component	Description	Suggested Part
$R_{G(EXT)}$	Gate Resistance, External	2.0 Ω , 2 W	CRM2512-JW-2R2ELF
C_G	Gate Capacitance	10 nF	C1812C103J1GACTU
R_{CG}	Damping Resistor	1.0 Ω , 0.5 W	ERJ-1TYJ1R0U
D_{RG}	Silicon Schottky Diode	40 V, 2 A	SS24T3G
R_b	BJT Base Resistor	1.0 Ω , 0.5 W	ERJ-1TYJ1R0U
Q_{HA}, Q_{HB}	Current Boost NPN	40 V, 8 A, Silicon NPN BJT	MJD44H11
Q_{LA}, Q_{LB}	Current Boost PNP	40 V, 8 A, Silicon PNP BJT	MJD45H11
U1	Signal Isolator	Opto-Isolator –or– Transformer Isolator	ACPL-4800 / ADUM3210
X1	DC/DC Converter, V_{GH} Supply	$V_{OUT} = +20$ V, $V_{IN} = +12$ V, 2 W, $V_{ISO} = 5.2$ kV	MGJ2D122005SC
X2	DC/DC Converter, V_{GL} Supply	$V_{OUT} = +5$ V, $V_{IN} = +12$ V, 3 W, $V_{ISO} = 3.0$ kV	MEV3S1205SC
X3	DC/DC Converter, V_{EE} Supply	$V_{OUT} = -5$ V, $V_{IN} = +12$ V, 2 W, $V_{ISO} = 5.2$ kV	MGJ2D122005SC

B:2: Voltage Supply Selection

The IX2204 gate drive design requires three supply voltages V_{GH} , V_{GL} , and V_{EE} (listed in Table 2) optionally supplied through DC/DC converters. During device turn-on, V_{GH} charges the external capacitor C_G thereby delivering the narrow width, high current pulse $I_{G,on}$ to the SJT gate and charges the SJT's internal terminal capacitances C_{GD} and C_{GS} . For a given level of parasitic inductance in the gate circuit and SJT package, the rise time of $I_{G,on}$ is controlled by the choice of V_{GH} and C_G . During the steady on-state, V_{GL} in combination with the internal and external gate resistances provides a continuous gate current for the GA03JT12-247 to remain on. The V_{EE} supply sets the gate negative during turn-off and steady off-state for faster switching and to avoid spurious turn-on which may be caused by external circuit noise. The power rating of the voltage supplies should be adequate to meet the gate drive power requirements as determined by

$$P_{min,VGH} = \frac{1}{2} C_G V_{GH}^2 f_{sw}$$

$$P_{min,VEE} = \frac{1}{2} C_G V_{EE}^2 f_{sw}$$

$$P_{min,VGL} = V_{GL} I_{G,steady} D$$

Table 2: IX2204 Gate Drive Example Component List

Symbol	Parameter	Values	
		Range	Typical
V _{GH}	Supply Voltage, Driver Output A	15 – 20	+ 20.0
V _{GL}	Supply Voltage, Driver Output B	5.0 – 7.0	+ 5.0
V _{EE}	Negative Supply Voltage	-10 – GND	- 5.0

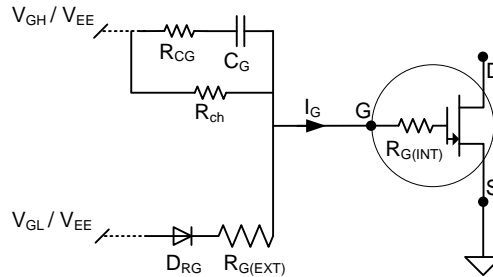
B:3: Gate Capacitor C_G Selection

Figure 23: Primary gate drive circuit passive components with series gate resistance Schottky rectifier.

An external gate capacitor C_G connected directly to the device gate pin delivers the positive current peak I_{G,on} during device turn-on and the negative current peak I_{G,off} during turn-off. A low value resistor R_{CG} is connected in series with C_G to damp potential high-frequency oscillation. A high value resistor R_{ch} in parallel with C_G sets the SJT gate to a defined potential (-V_{EE}) during steady off-state.

At device turn-on, C_G is pulled to V_{GH} which produces a transient peak of gate voltage and current. This current peak rapidly charges the internal SJT C_{GS} and C_{GD} capacitances. A Schottky diode, D_{RG}, in series with R_{G(EXT)} blocks any C_G induced current from draining out through R_{G(EXT)} and ensures that all of the charge within C_G flows only into the device gate, allowing for an ultra-fast device turn-on. During steady on-state, a potential of V_{GH} - V_{GS} = V_{GH} - 3 V is across C_G. When the device is turned off, C_G is pulled to negative V_{EE} and V_{GS} is pulled to a transient peak of V_{GS,turn-off} = V_{EE} - (V_{GH} - 3 V), this induces the negative current peak I_{G,off} out of the gate which discharges the SJT internal capacitances.

B:4: External Gate Resistor R_{G(EXT)} Selection

An external gate resistor R_{G(EXT)} connected directly to the SJT gate pin acts to deliver a continuous current I_{G,steady} during steady on-state. The gate current is determined by:

$$I_{G,steady} = \frac{V_{GL} - V_{GS(FWD)} - V_{Sch}}{R_{G(EXT)} + R_{G(INT-ON)}}$$

The on-state gate-source voltage V_{GS(FWD)} can be approximated to 3 V and the Schottky on-state voltage V_{Sch} can be approximated to 0.3 V which simplifies the equation to:

$$I_{G,steady} = \frac{V_{GL} - 3.3V}{R_{G(EXT)} + R_{G(INT-ON)}}$$

The desired I_{G,steady} is determined by the peak device junction temperature T_J during operation, drain current I_D, DC current gain h_{FE}, and a 50 % safety margin to avoid operating the device in saturation. I_{G,steady} may also be approximated from the temperature dependent on-state curves of the device in Figures 1 – 3, provided that a 50 % increase is given.

Table 3: Passive Output Component List

Symbol	Parameter	Values		Units
		Range	Typical	
C _G	Gate Capacitor, External	5 – 20	10	nF
R _{CG}	Damping Resistor of Gate Capacitor	0.5 – 2.0	1.0	Ω
R _{ch}	Charging Resistor	500 – 10k	1k	Ω
R _{G(EXT)}	Gate Resistor, External	0.4 – 5	2.0	Ω
R _{G(INT-ON)}	Gate Resistance, Internal, On-State	0.8 – 1.5	0.9	Ω
D _{RG}	Schottky Diode of Gate Resistor	--	--	

B:5: Optional Gate Current Boost Network

An optional output totem-pole network may be attached to the IX2204 output pins as shown in Figure 22 using either silicon BJTs (shown) or MOSFETs. This configuration allows the IX2204 to directly drive the BJT bases or MOSFET gates and not supply the full peak and steady state gate current entering the SJT gate. The primary gate current delivery device is transferred to the discrete components which have higher power dissipation ratings than the IX2204.

B:6: Voltage Supply Isolation

The DC/DC supply voltage converters are suggested to provide isolation at a minimum of twice the working V_{DS} on the SJT transistor during off-state to provide adequate protection to circuitry external to the gate drive circuit. Suggested DC/DC converters have an isolation of 3.0 kV or greater. Alternatively, DC/DC converter galvanic isolation may be bypassed and direct connection of variable voltage supplies may be done, this may be convenient during testing and prototyping but carries risk and is not suggested for extended usage.

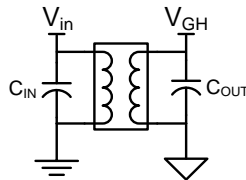

Figure 24: Typical DC/DC converter configuration

B:7: Signal Isolation

The gate supply signal is suggested to be isolated to twice the working V_{DS} on the SJT during off-state to provide adequate protection to circuitry external to the gate drive circuit. This may be done using opto or galvanic isolation techniques.

B:8: Additional Features

The IX2204 has additional functionality available which is unused in the given configuration. Desaturation detection and fault status monitoring may be implemented by un-grounding the DESAT, BLANK, and TRISTATE pins and configuring them as recommended in the IX2204 datasheet, available from IXYS. Active miller clamping is also available on other gate drive ICs which may also be desired in some SJT switching applications but is not required, refer to specific gate drive IC datasheets for more information.

C: Alternative Gate Drive ICs

Table 4 features a partial list of alternative gate drive ICs which may be used for driving the GA03JT12-247; specific product information should be obtained from the individual product manufacturers.

Table 4: Additional Commercial Gate Drivers Compatible with GA06JT12-247

Manufacturer	Part Number	Features					Number of Outputs
		Optical Signal Isolation	Desaturation Detection	Active Miller Gate Clamping ³	High Side Capability		
Avago Tech.	HCPL-316J	✓	✓	–	✓	1	
Avago Tech.	HCPL-322J	✓	✓	✓	✓	1	
IXYS	IXD_604	–	–	–	✓	2	
IXYS	IXD_614	–	–	–	✓	1	
Micrel	MIC4452YN	–	–	–	✓	1	
Microsemi	LX4510	–	–	–	✓	1	
Texas Instruments	UCC27322	–	–	–	✓	1	

³ – Active Miller Gate Clamping recommended for $V_{EE} = GND$ switching applications as SJT and/or output BJT secondary gate discharge path.

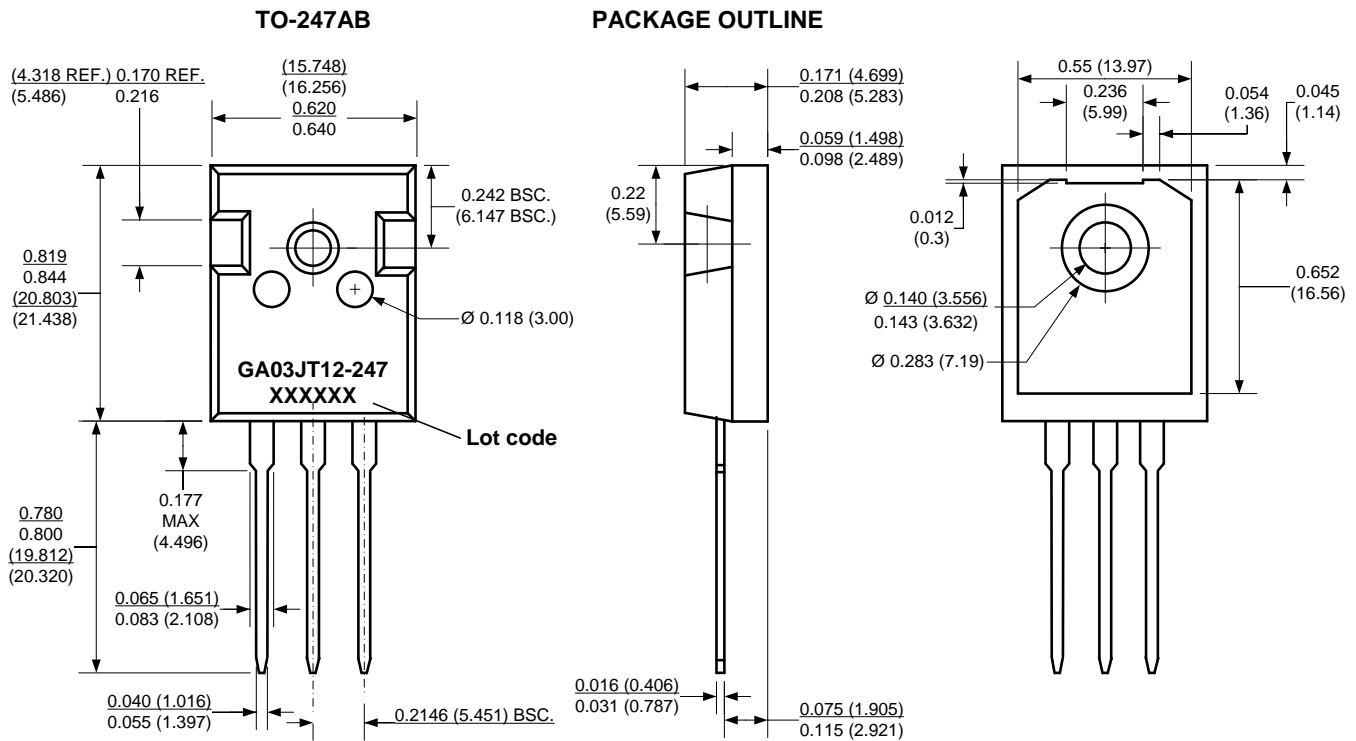
Package Dimensions

NOTE

1. CONTROLLED DIMENSION IS INCH. DIMENSION IN BRACKET IS MILLIMETER.
2. DIMENSIONS DO NOT INCLUDE END FLASH, MOLD FLASH, MATERIAL PROTRUSIONS

Revision History			
Date	Revision	Comments	Supersedes
2014/08/26	7	Updated Electrical Characteristics	
2014/02/05	6	Updated Electrical Characteristics	
2013/12/18	5	Updated Gate Drive Section	
2013/11/12	4	Updated Electrical Characteristics	
2013/08/30	3	Updated Switching Characteristics	

Published by
 GeneSiC Semiconductor, Inc.
 43670 Trade Center Place Suite 155
 Dulles, VA 20166

GeneSiC Semiconductor, Inc. reserves right to make changes to the product specifications and data in this document without notice.

GeneSiC disclaims all and any warranty and liability arising out of use or application of any product. No license, express or implied to any intellectual property rights is granted by this document.

GeneSiC is not responsible for third-party component performance and does not guarantee similar results.

Unless otherwise expressly indicated, GeneSiC products are not designed, tested or authorized for use in life-saving, medical, aircraft navigation, communication, air traffic control and weapons systems, nor in applications where their failure may result in death, personal injury and/or property damage.

SPICE Model Parameters

This is a secure document. Please copy this code from the SPICE model PDF file on our website (http://www.genesicsemi.com/images/products_sic/sjt/GA03JT12-247_SPICE.pdf) into LTSPICE (version 4) software for simulation of the GA03JT12-247.

```
*      MODEL OF GeneSiC Semiconductor Inc.
*
*      $Revision:   1.2           $
*      $Date:      26-AUG-2014   $
*
*      GeneSiC Semiconductor Inc.
*      43670 Trade Center Place Ste. 155
*      Dulles, VA 20166
*
*      COPYRIGHT (C) 2014 GeneSiC Semiconductor Inc.
*      ALL RIGHTS RESERVED
*
* These models are provided "AS IS, WHERE IS, AND WITH NO WARRANTY
* OF ANY KIND EITHER EXPRESSED OR IMPLIED, INCLUDING BUT NOT LIMITED
* TO ANY IMPLIED WARRANTIES OF MERCHANTABILITY AND FITNESS FOR A
* PARTICULAR PURPOSE."
* Models accurate up to 2 times rated drain current.
*
.model GA03JT12 NPN
+ IS      3.01E-49
+ ISE     1.00E-27
+ EG      3.2
+ BF      58.5
+ BR      0.55
+ IKF     200
+ NF      1
+ NE      2
+ RB      18.0
+ RBM     0.9
+ IRB     1e-4
+ RE      0.184170194
+ RC      0.342829806
+ CJC     1.37E-10
+ VJC     3.150960833
+ MJC     0.43821105
+ CJE     2.97E-10
+ VJE     2.901930244
+ MJE     0.475141754
+ XTI     3
+ XTB     -1.24
+ TRC1    5.00E-3
+ VCEO    1200
+ ICRATING 3
+ MFG     GeneSiC_Semiconductor
*End of GA03JT12 SPICE Model
```