

ignion^N

Your innovation.
Accelerated.

NANO mXTEND™: MINIATURE AND HIGH EFFICIENCY BLUETOOTH/WI-FI ANTENNA

USER MANUAL
NANO mXTEND™ (NN02-101)

NANO mXTEND[™]

MINIATURE AND HIGH-EFFICIENCY BLUETOOTH/WI-FI ANTENNA

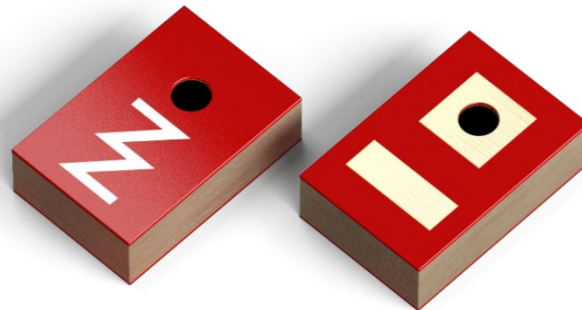

NN02-101

NANO mXTEND[™] | Bluetooth & Wi-Fi

Operating range: 2400 – 10600 MHz

Best for: 2400 – 2500 MHz

Dimensions : 3.0 mm x 2.0 mm x 0.8 mm

What is the NANO mXTEND[™]?

The **NANO mXTEND[™]** is the smallest Virtual Antenna[®] chip to date. Featuring a size of only 3 mm x 2 mm x 0.8 mm, this off-the-shelf chip antenna has been designed to fit almost every **IoT device** from entry-level to high-end products. The **NANO mXTEND[™]** is enabled by Virtual Antenna[®] technology, thus featuring the unique properties of this class of products: easy to use; versatile, and broadly tunable. The **NANO mXTEND[™]** is available for Bluetooth, Wi-Fi, Wi-SUN, and any wireless connectivity protocol operating in the 2.4 - 2.5 GHz band. Due to Ignion's proprietary Virtual Antenna[®] technology, this chip antenna is non-resonant and therefore broadly tunable, enabling additional frequency bands to be supported by the same antenna part and released in the future.

As with every other Virtual Antenna[®] chip, the **NANO mXTEND[™]** is available through Ignion's **Antenna Intelligence Cloud** tool, enabling predictable design and performance throughout the entire product development cycle. Moreover, the **NANO mXTEND[™]** is built on a glass epoxy substrate, making its manufacturing broadly available and therefore resilient against shortage.

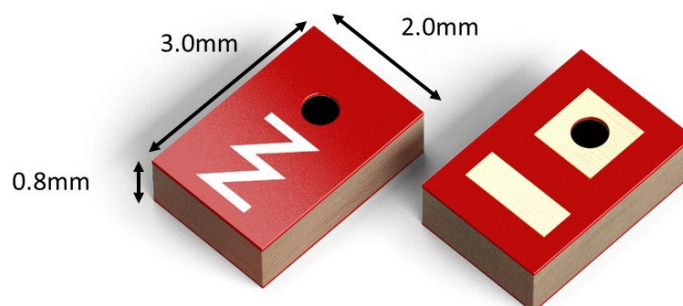

Material: The NANO mXTEND[™] antenna booster is built on a glass epoxy substrate.



What is the NANO mXTEND[™] used for?

The **NANO mXTEND[™]** is suitable for embedding an antenna into any wireless device requiring optimum performance in a small, cost-effective package for operating in the Bluetooth/Wi-Fi/Wi-SUN ISM 2.4 GHz frequency bands, including:

- Asset Trackers
- Smart Tags
- Earphones and Headsets
- Wearables
- Logistic Trackers
- Health sensors
- Animal Trackers
- Security Sensors
- Service Buttons
- Environmental Sensors
- IoT Developer Kits
- Wireless Sniffing Sensors

What differentiates the NANO mXTEND™ from other chip antennas?

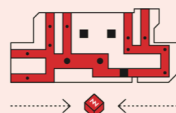
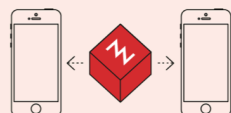
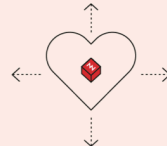
Like every other Virtual Antenna® product, the NANO mXTEND™ is frequency neutral, meaning that its frequency response is not determined by the antenna component but designed by the electronics engineer. Virtual Antenna® technology provides the broadest range of connectivity options with desired antenna performance in the smallest ever form factor. This unique technology enables the whole mXTEND™ range of components to become tiny, off-the-shelf, surface-mount (SMD) electronic chips while still providing connectivity with multiple frequency bands and meeting the requirements of most wireless devices' architectures and form factors. Being non-resonant, the whole antenna performance can be customized through a shorter and easier design cycle by means of a matching circuit, while benefiting at the same time from a robust, reliable, and cost-effective manufacturing process because of the chip, SMD form factor. Also, the NANO mXTEND™'s architecture is not using ceramic materials to achieve miniaturization, which ensures a pervasive availability of raw materials thus making the supply chain resilient to shortage and price fluctuations.

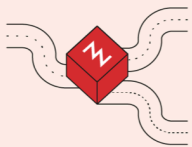
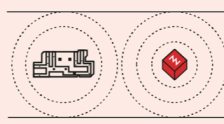
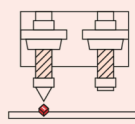
			
<p>Off-the-shelf Ready to be delivered 'as is' with no need for customization.</p>	<p>Up to 10 times smaller A booster can be 5³mm³ providing the same connectivity.</p>	<p>Versatility A phone can be designed with several architectures yet still using the same component.</p>	<p>Scalability The 'heart' of the design can be reused across multiple device models.</p>
<hr style="border: 0; border-top: 1px solid red; margin: 10px 0;"/>			
			
<p>Modular Modules or standard building blocks can be re-used in the design of multiple devices.</p>	<p>Multiband A single antenna provides connectivity in 2G, 3G and 4G band.</p>	<p>Full performance The same performance in a much smaller, off-the-shelf and versatile component.</p>	<p>Pick & place No manual assembly is needed, only a conventional SMT machine.</p>

Click to view other useful NANO mXTEND™ guidelines:

[HOW TO EMBED A VIRTUAL ANTENNA®](#)

[MECHANICAL SPECIFICATIONS](#)

[ASSEMBLY AND MANUFACTURING](#)

[PACKAGING](#)

Chapter Index

The NANO mXTEND[™] for Bluetooth/Wi-Fi	9
CORNER MOUNTING CONFIGURATION	9
MATCHING NETWORK	11
VSWR AND TOTAL EFFICIENCY	12
RADIATION PATTERNS, GAIN, AND EFFICIENCY	13
EDGE MOUNTING CONFIGURATION	14
MATCHING NETWORK	15
VSWR AND TOTAL EFFICIENCY	16
RADIATION PATTERNS, GAIN, AND EFFICIENCY	17
MECHANICAL SPECIFICATIONS	18
DIMENSIONS, TOLERANCES, AND RoHS	18
INK COLOR RANGE	18
RECOMMENDED FOOTPRINT FOR THE NN02-101	19
ASSEMBLY AND MANUFACTURING	21
PACKAGING	23

How to embed Virtual Antenna[®]

Design with Virtual Antenna[®] in 1-2-3

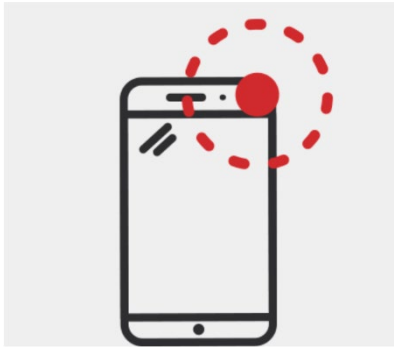

STEP 1: Place the antenna component

1. Select one corner of your PCB
2. Ensure your ground plane meets the NANO mXTEND[™] clearance area restrictions
3. Respect a keep out space around the booster. Keep at least 5mm distance from metallic objects

Look [here](#) for an example of antenna placement

STEP 2: Design your matching network

1. Through a combination of inductors & capacitors obtain 50 Ohms of antenna impedance to optimize the transfer of energy to your antenna
2. It is critical to fine-tune your MN throughout the entirety the design process to achieve your desired frequency response



Look [here](#) for an example of a matching network for a Virtual Antenna[®] product application via simulation

STEP 3: Test your device

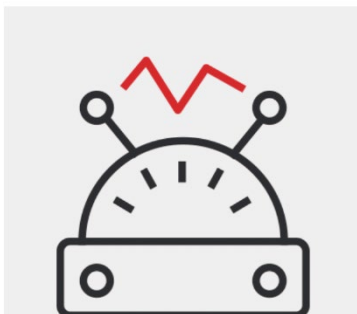

1. Perform a field test in which your antenna is placed in its final housing. Fine-tune the MN if needed.
2. Use a network analyzer to adjust mismatch
3. Test the antenna's efficiency with an anechoic chamber

Look [here](#) for a short video tutorial on how to test your antenna.

<https://ignion.io/design-center/tutorials-webinars/>

Scan this QR code
to see our videos
highlighting these
three easy steps



Need further help? Easy start with Antenna Intelligence Cloud

Do you need more help with your antenna for your device?

Use our **Antenna Intelligence Cloud service** and get your ready-to-test, proof-of-concept antenna design especially simulated for your platform **free of charge**¹, and in **24 hours**.

<https://www.ignion.io/antenna-intelligence/>

¹ *Subject to terms and conditions [here](#).*



Scan QR code to
be taken to our
Antenna
Intelligence Cloud
page

The NANO mXTEND[™] for Bluetooth/Wi-Fi

The NANO mXTEND[™] has been designed for **Bluetooth/Wi-Fi** connectivity at 2.4 GHz. An optimum tuning of this chip at the 2.4 GHz band is achieved through a matching network. Due to its versatility, the chip antenna component can be mounted both on the corner or on the center of an edge of the printed circuit board (PCB) of your wireless device just by changing the matching network. The table below includes a quick reference guide for the antenna specifications on a reference design of 80 x 40 mm, as well as the set-up matching network and performance for both a corner and an edge mounting configuration.

QUICK REFERENCE GUIDE

Technical Specs for the NANO mXTEND[™] in the corner configuration:

Technical features	2400 – 2500 MHz
Average Efficiency	>55 %
Peak Gain	2.4 dBi
VSWR	< 2.5:1
Radiation Pattern	Omnidirectional
Polarization	Linear
Weight (approx.)	0.01 g.
Temperature	-40 to +125 °C
Impedance	50 Ω
Dimensions (L x W x H)	3.0 mm x 2.0 mm x 0.8 mm

Table 1 – Technical Features. Measurements from the evaluation board (Figure 1)

Technical Specs for the NANO mXTEND[™] in the edge configuration:

Technical features	2400 – 2500 MHz
Average Efficiency	>65 %
Peak Gain	2.4 dBi
VSWR	< 3.0:1
Radiation Pattern	Omnidirectional
Polarization	Linear
Weight (approx.)	0.01 g.
Temperature	-40 to +125 °C
Impedance	50 Ω
Dimensions (L x W x H)	3.0 mm x 2.0 mm x 0.8 mm

Table 2 – Technical Features. Measurements from the evaluation board (Figure 4)

CORNER MOUNTING CONFIGURATION

The NANO mXTEND[™] is ready and recommended for corner mounting in those devices where this region is available for antenna placement. This section details a corner mounting design on a reference ground plane of 80 mm x 40 mm including a clearance area of 5 mm x 5 mm (Figure 1). Other ground plane sizes and clearances can be implemented by adapting the matching network.

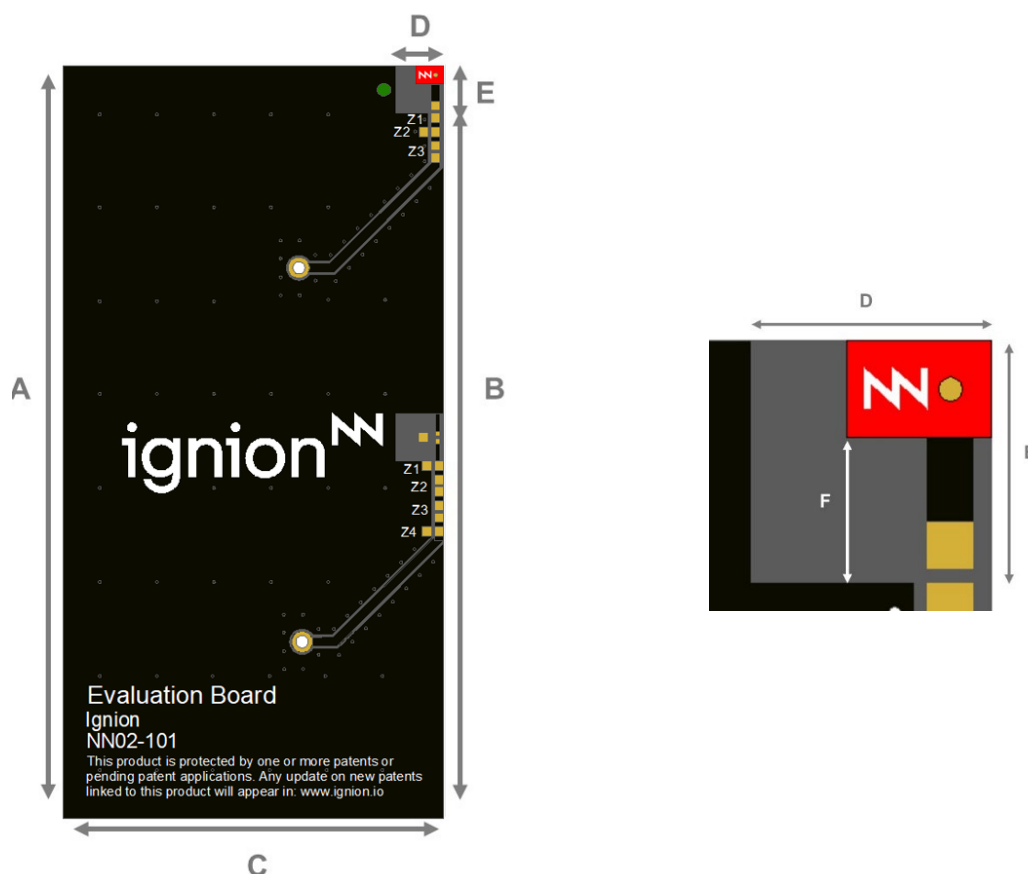

Measure	mm
A	80
B	75
C	40
D	5
E	5
F	3

Tolerance: ±0.2 mm

D: Length of clearance area.

Figure 1 - EB_NN02-101_c_BT. Evaluation board configured to provide operation at Bluetooth (2400 – 2500MHz).

This product and its use are protected by at least one or more of the following [patents and patent applications](#) PAT. US 62/529032; and other domestic and international patents pending.

MATCHING NETWORK

The NANO mXTEND™ antenna booster needs a matching network to ensure optimal performance in the 2.4 GHz – 2.5 GHz frequency range. This section presents a suitable matching network for the corner mounting configuration (Figure 7). Please note that different form factors, RF ground planes, and nearby components may require a different matching network.

If you need assistance to design your matching network beyond this application note, please contact support@ignion.io, or if you are designing a **different device size** or a **different frequency band**, we can assist you in less than 24 hours. Please, try our free-of-charge¹ [Antenna Intelligence Cloud](#), which will get you a complete design report including a custom matching network for your device in 24h¹. Additional information related to Ignion's range of R&D services is available at: <https://ignion.io/rdservices/>

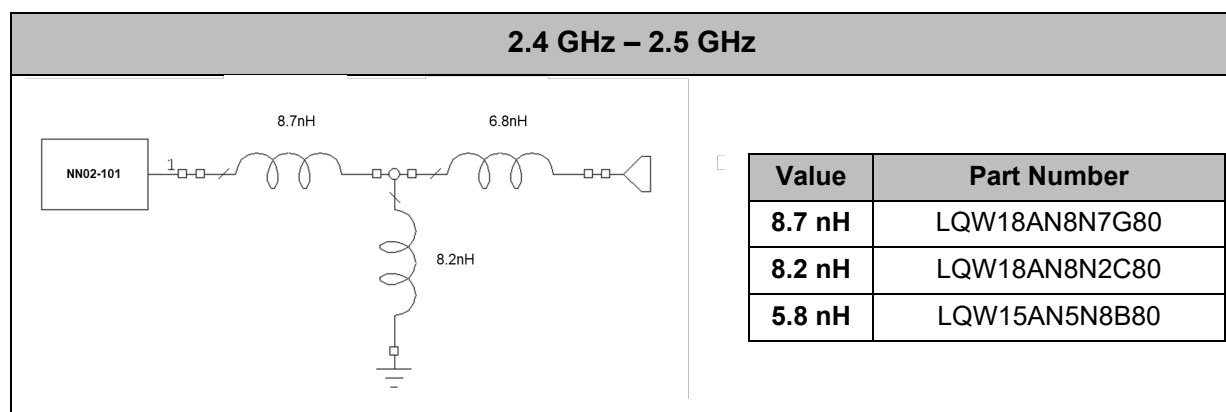

Figure 2 – Matching network implemented on the Evaluation Board (Figure 1) for covering Bluetooth from 2.4GHz to 2.5GHz.

For an optimal result, the use of high-quality factor (Q) and tight tolerance components is highly recommended (e.g., Murata components with part numbers as shown in **Figure 2**). The antenna performance is always conditioned by its operating environment meaning that differences in the device, including differences in printed circuit board sizes, components near the antenna, displays, batteries, covers, connectors, etc. affect the antenna performance. Accordingly, placing pads compatible with 0402 and 0603 SMD components for a matching network as close as possible to the feeding point of the antenna element is highly recommendable. It is also recommendable to do this in the ground plane area, not in the clearance area. By tuning the matching network in your final design after your final surrounding components are in place (batteries, displays, covers, etc.) you will be able to optimize the antenna performance without changing the antenna part or the design.

¹ See terms and conditions for a free Antenna Intelligence Cloud service in 24h at: <https://www.ignion.io/antenna-intelligence/>

VSWR AND TOTAL EFFICIENCY

VSWR (Voltage Standing Wave Ratio) and Total Efficiency versus Frequency (GHz).

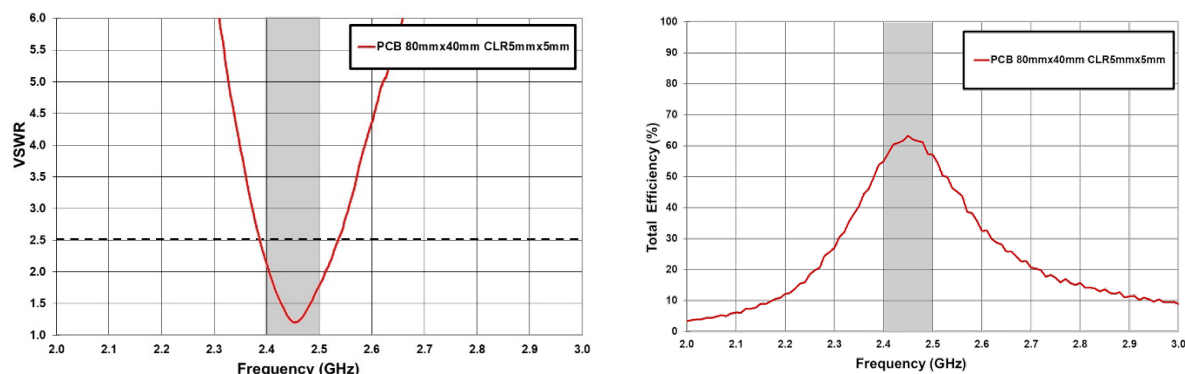

Figure 3 - VSWR and Total Efficiency for the 2.4 – 2.5 GHz frequency range as observed on the evaluation board EB_NN02-101_c_BT (Figure 1).

	2.4 – 2.5GHz				
NANO mXTEND [™]	η_a 2400MHz	η_a 2500MHz	Min	Max	Av. η_a
On the corner	54.9	57.1	54.9	63.2	60.1

Table 3 - Antenna efficiency comparison considering the evaluation board EB_NN02-101_c_BT (Figure 1).

The NANO mXTEND[™] operates at the required Bluetooth/Wi-Fi frequency spectrum with high-efficiency values. Please note that its high performance can be sustained even with a reduced clearance area.

RADIATION PATTERNS, GAIN, AND EFFICIENCY

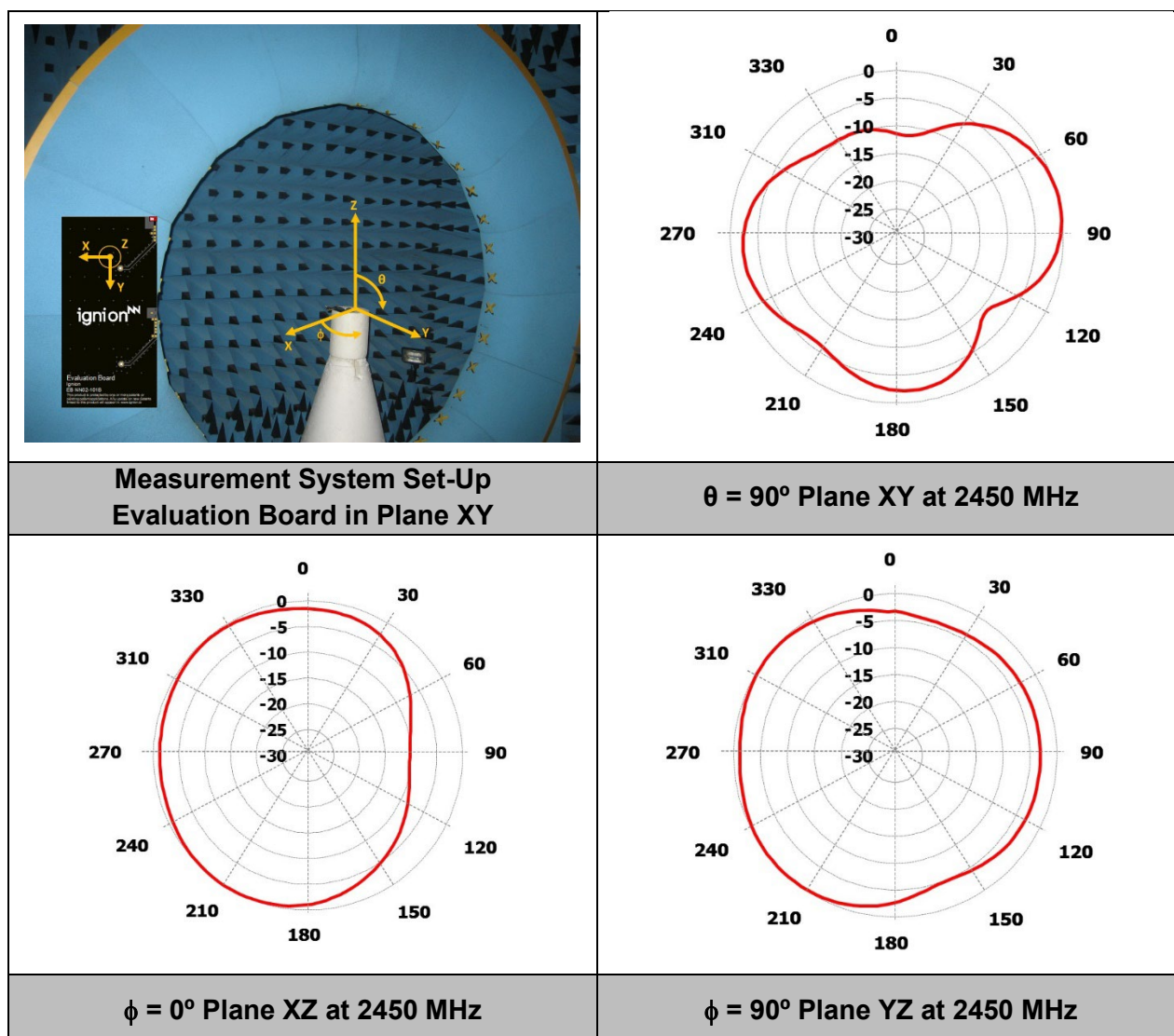

Gain	Peak Gain	2.4 dBi
	Average Gain across the band	2.2 dBi
	Gain Range across the band (min, max)	1.9 dBi <-> 2.4 dBi
Efficiency	Peak Efficiency	75.4 %
	Average Efficiency across the band	71.9 %
	Efficiency Range across the band (min, max)	66.3 – 75.4 %

Table 4 – Antenna Gain and total efficiency from the evaluation board (Figure 1) Bluetooth band. Measurements made in the STARLAB 18 anechoic chamber.

EDGE MOUNTING CONFIGURATION

In devices such as dual-hand gaming handhelds and landscape handheld devices, the center of the edge can be the ideal placement area for your chip antenna, This section details a design example and evaluation board (80 mm x 40 mm with 4 mm x 4 mm of ground clearance) in such an edge mounting configuration (Figure 4).

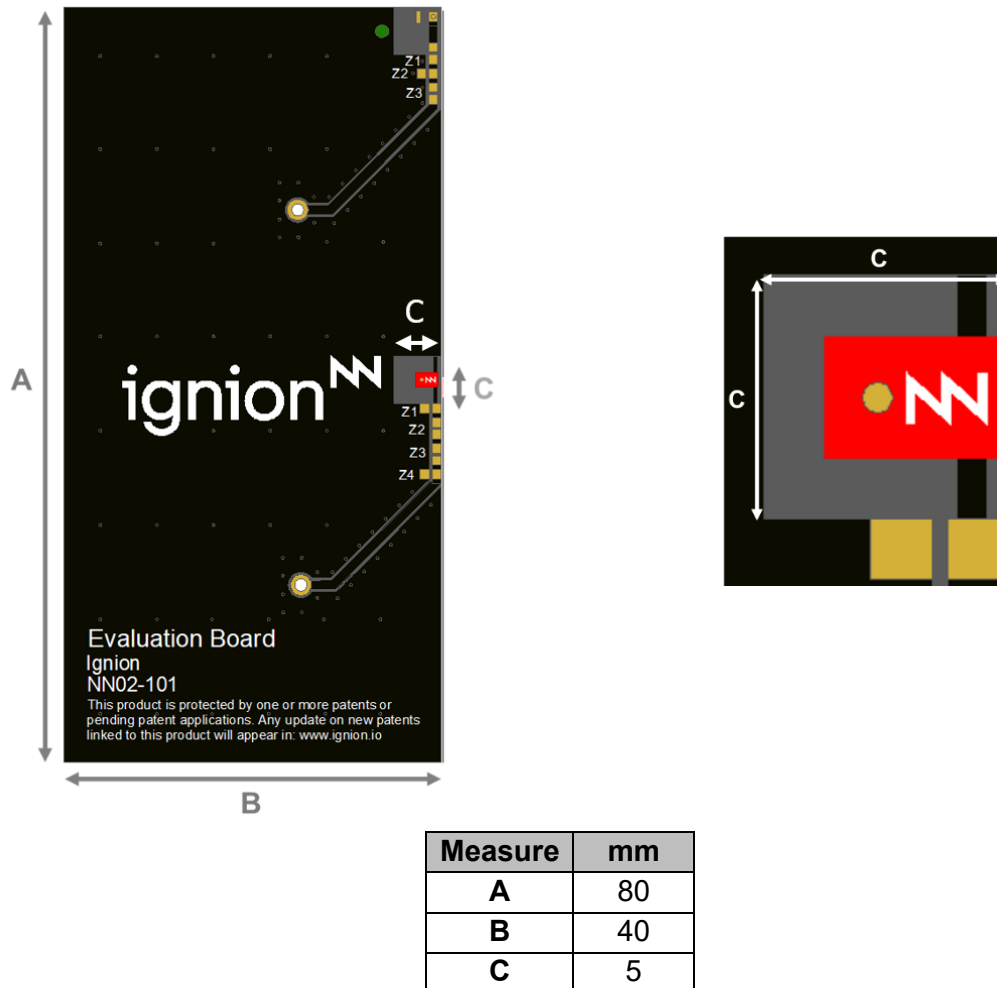

Tolerance: ±0.2 mm

C: Length of clearance area.

Figure 4 - EB_NN02-101_m_BT. Evaluation board providing operation at Bluetooth (2400 – 2500 MHz).

MATCHING NETWORK

By simply changing the matching network, the NANO mXTEND™ can also deliver optimal performance in an edge mounting configuration. A suitable matching network for edge mounting in the reference board pictured above is shown in Fig.5. Please note that different form factors of your wireless device and its RF ground planes, and the proximity of other elements such as shields, covers, connectors and the like might result in the need for a fine-tuning of the matching network.

If you need assistance to design your matching network beyond this application note, please contact support@ignion.io, or if you are designing a **different device size** or a **different frequency band**, we can assist you in less than 24 hours. Please, try our free-of-charge¹ [Antenna Intelligence Cloud](#), which will get you a complete design report including a custom matching network for your device in 24h². Additional information related to Ignion's range of R&D services is available at: <https://ignion.io/rdservices/>

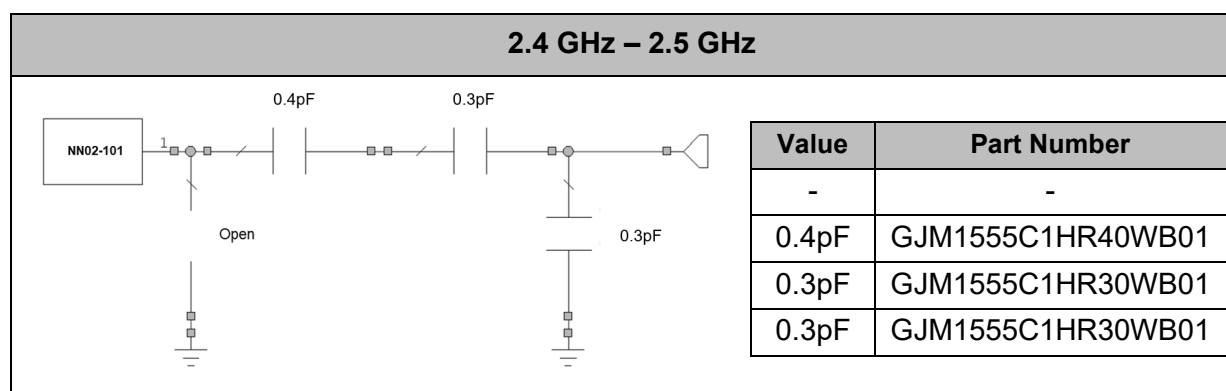

Figure 5 – Matching network implemented in the Evaluation Board (Figure 4) for covering Bluetooth from 2.4GHz to 2.5GHz.

To ensure optimal results, the use of high-quality factor (Q) and tight tolerance components is highly recommended (e.g. Murata components with part numbers as shown in **Figure 5**). The antenna performance is always conditioned by its operating environment meaning that differences in the device, including differences in printed circuit board sizes, components near the antenna, displays, batteries, covers, connectors, etc. affect the antenna performance. Accordingly, placing pads compatible with 0402 and 0603 SMD components for a matching network as close as possible to the feeding point of the antenna element is highly recommendable. It is recommended to do this in the ground plane area, not in the clearance area. By tuning the matching network in your final design after your final surrounding components are in place (batteries, displays, covers, etc.) you will be able to optimize the antenna performance without changing the antenna part, or the design.

² See terms and conditions for a free Antenna Intelligence Cloud service in 24h at: <https://www.ignion.io/antenna-intelligence/>

VSWR AND TOTAL EFFICIENCY

VSWR (Voltage Standing Wave Ratio) and Total Efficiency versus Frequency (GHz).

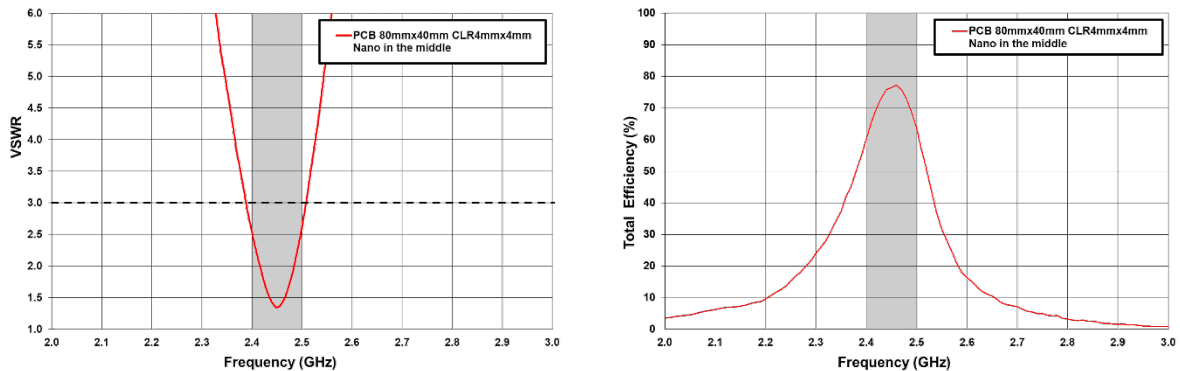

Figure 6 - VSWR and Total Efficiency for the 2.4 – 2.5 GHz frequency range configured to provide operation the evaluation board EB_NN02-101_m_BT (Figure 4).

		2400 – 2500 MHz				
NANO mXTEND™		η_a 2400MHz	η_a 2500MHz	Min	Max	Av. η_a
	On the middle	60.1	63.6	60.1	77.3	71.7

Table 5 - Antenna efficiency comparison configured to provide operation the evaluation board EB_NN02-101_m_BT (Figure 4).

The NANO mXTEND™ operates at the required Bluetooth/Wi-Fi frequency spectrum with high efficiency values. Please note that its high performance can be sustained even with the small 5x5 mm clearance area.

RADIATION PATTERNS, GAIN, AND EFFICIENCY

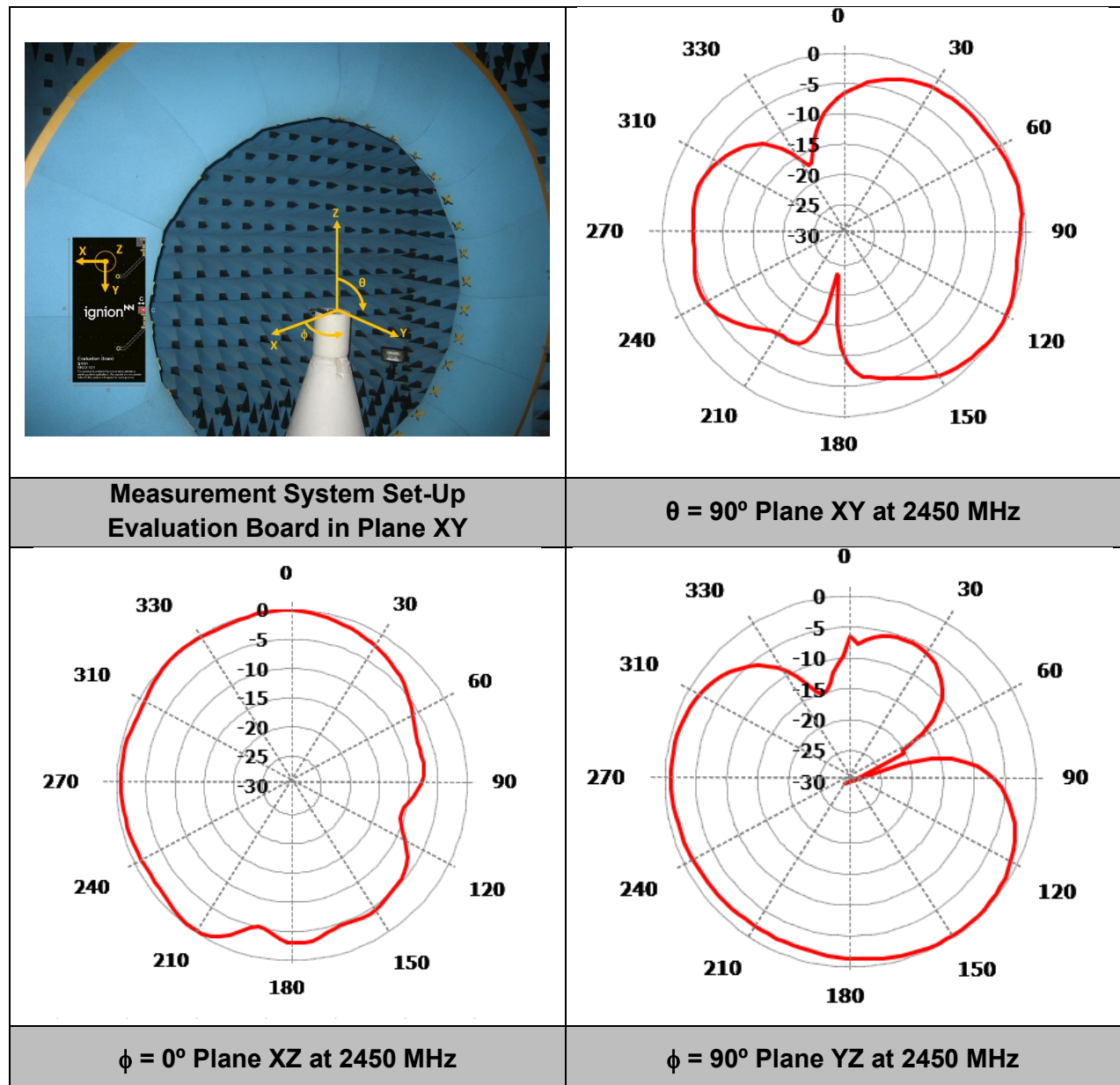

Gain	Peak Gain	1.1 dBi
	Average Gain across the band	0.85 dBi
	Gain Range across the band (min, max)	0.3 dBi <--> 1.1 dBi
Efficiency	Peak Efficiency	73.7 %
	Average Efficiency across the band	69.6 %
	Efficiency Range across the band (min, max)	70.0 – 73.7 %

Table 6 – Antenna Gain and total efficiency from the evaluation board (Figure 4) Bluetooth band. Measurements made in the STARLAB 18 anechoic chamber.

MECHANICAL SPECIFICATIONS

DIMENSIONS, TOLERANCES, AND RoHS

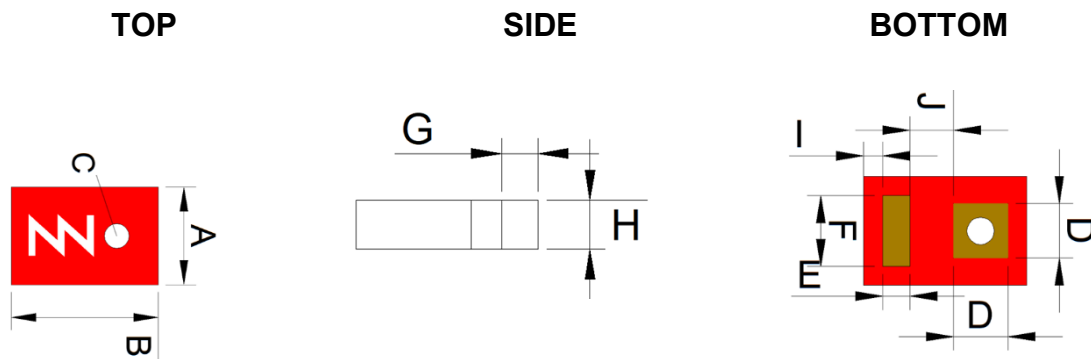

Dimension	mm	Dimension	mm
A	2.0	B	3.0
C	0.25	D	1.0
E	0.5	F	1.3
G	0.6	H	0.8
I	0.35	J	0.8

Figure 7 - NANO mXTEND™ antenna booster dimensions and tolerances.

The NANO mXTEND™ (NN02-101) antenna booster is compliant with the restriction of the use of hazardous substances (**RoHS**). For more information, please contact info@ignion.io.

INK COLOR RANGE

The next figure shows the range of colors in the NANO mXTEND™ antenna booster:

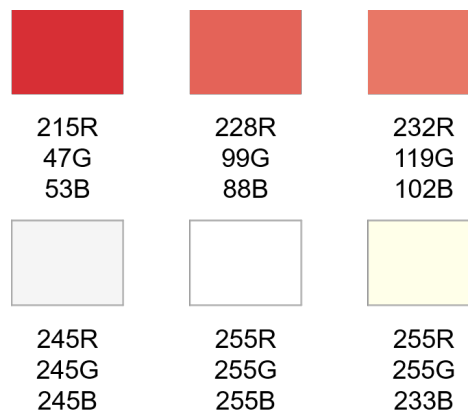

Acceptable color range

RECOMMENDED FOOTPRINT FOR THE NN02-101

See below the recommended footprint dimensions for the **NANO mXTEND™** (NN02-101) antenna booster on the **corner**.

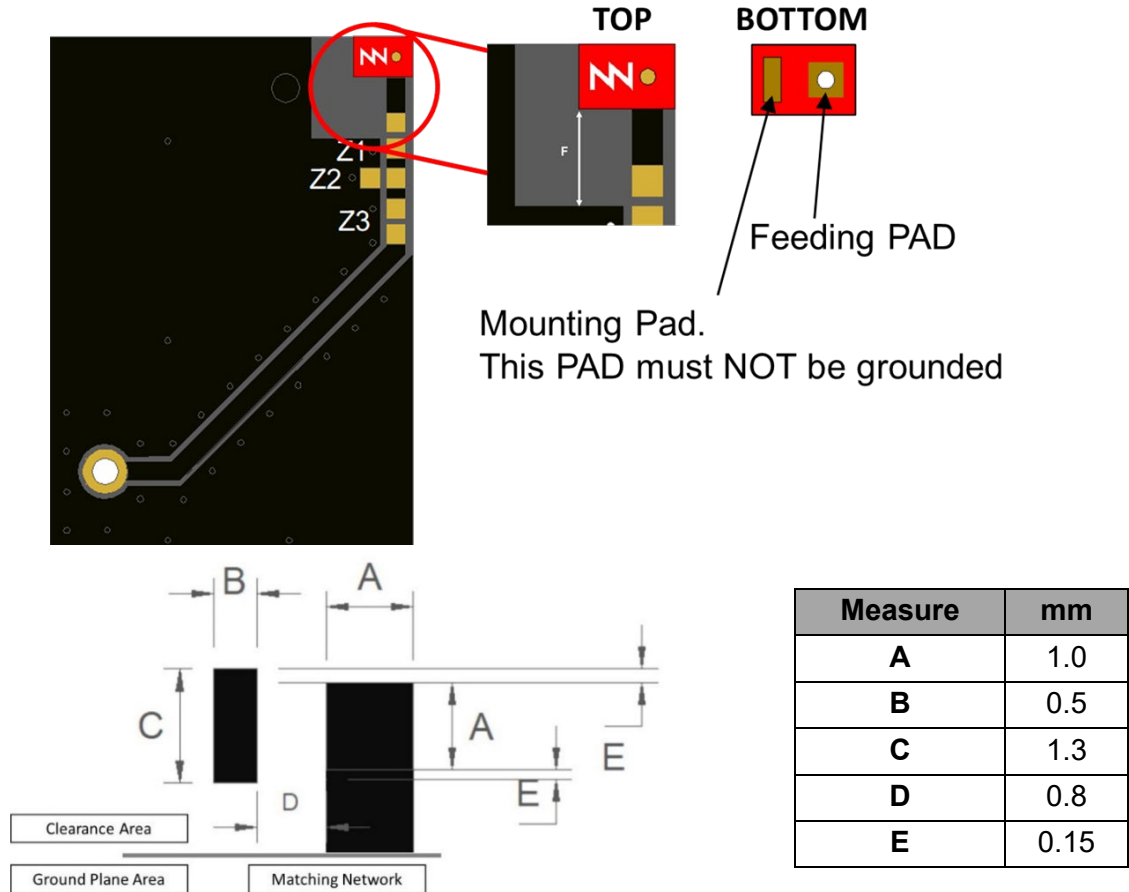

Tolerance: ±0.05mm

Figure 8 - Footprint dimensions for the NANO mXTEND™ (NN02-101) antenna booster (on the corner).

See below the recommended footprint dimensions for the **NANO mXTEND™** (NN02-101) antenna booster in the **middle**.

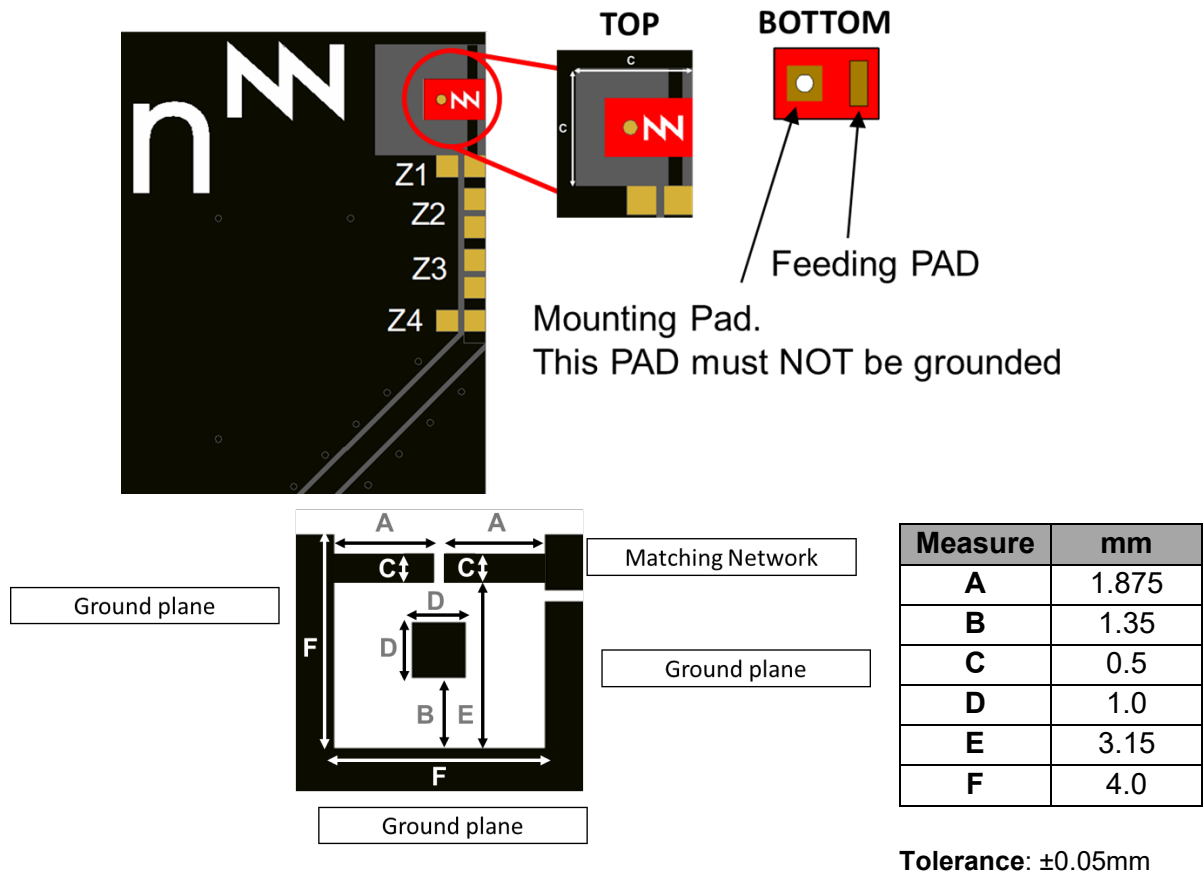

Figure 9 - Footprint dimensions for the NANO mXTEND™ (NN02-101) antenna booster (on the middle).

For additional support in the integration process, please contact support@ignion.io.

ASSEMBLY AND MANUFACTURING

Figure 10 shows the back and front views of the NANO mXTEND[™] (NN02-101) antenna booster.

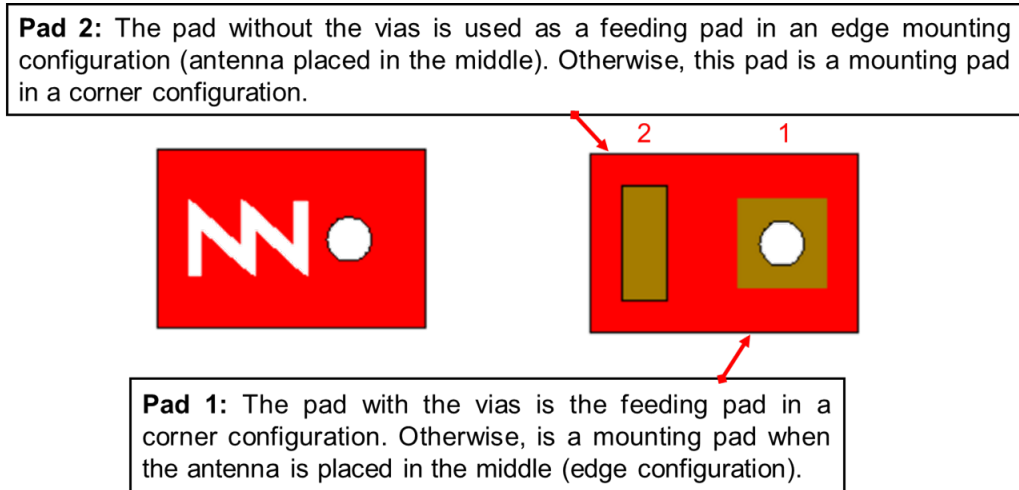

Figure 10 – Pads of the NANO mXTEND[™] (NN02-101) antenna booster.

As a surface mount device (SMD), the NANO mXTEND[™] antenna booster is compatible with industry standard soldering processes. The basic assembly procedure for the NANO mXTEND[™] antenna booster is as follows:

1. Apply a solder paste on the pads of the PCB. Place the NANO mXTEND[™] antenna booster on the board.
2. Perform a reflow process according to the temperature profile detailed in Figure 11.
3. After soldering the NANO mXTEND[™] antenna booster to the circuit board, perform a cleaning process to remove any residual flux. Ignion recommends conducting a visual inspection after the cleaning process to verify that all reflux has been removed.

The figure below shows the soldering details obtained after a correct assembly process:

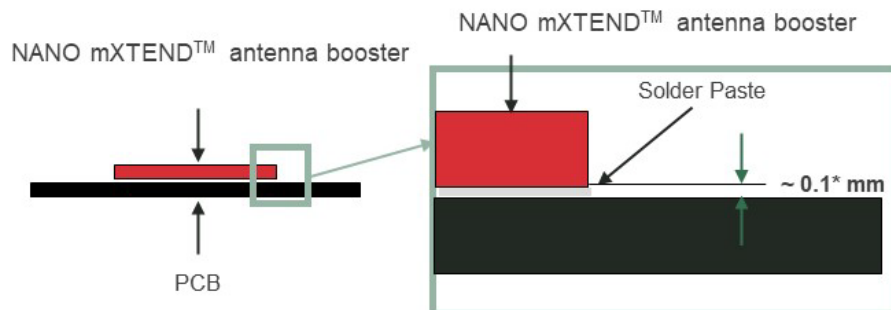

Figure 11 - Soldering details

NOTE (*): Solder paste thickness after the assembly process will depend on the thickness of the soldering stencil mask. A stencil thickness equal to or larger than 127 microns (5 mils) is required.

The NANO mXTEND™ (NN02-101) antenna booster can be assembled following the Pb-free assembly process. According to the **IPC/JEDEC J-STD-020C** Standard, the suggested temperature profile is as follows:

Phase	Profile features	Pb-Free assembly (Sn Ag Cu)
RAMP-UP	Avg. Ramp-up Rate (T _{smax} to T _p)	3 °C / second (max.)
PREHEAT	<ul style="list-style-type: none"> - Temperature Min (T_{smin}) - Temperature Max (T_{smax}) - Time (t_{smin} to t_{smax}) 	150 °C 200 °C 60-180 seconds
REFLOW	<ul style="list-style-type: none"> - Temperature (T_L) - Total Time above T_L (t_L) 	217 °C 60-150 seconds
PEAK	<ul style="list-style-type: none"> - Temperature (T_p) - Time (t_p) 	260 °C 20-40 seconds
RAMP-DOWN	Rate	6 °C/second max
Time from 25 °C to Peak Temperature		8 minutes max

Table 7 – Recommended soldering temperatures.

The next graphic shows the temperature profile (grey zone) for the NANO mXTEND™ antenna booster assembly process reflow ovens.

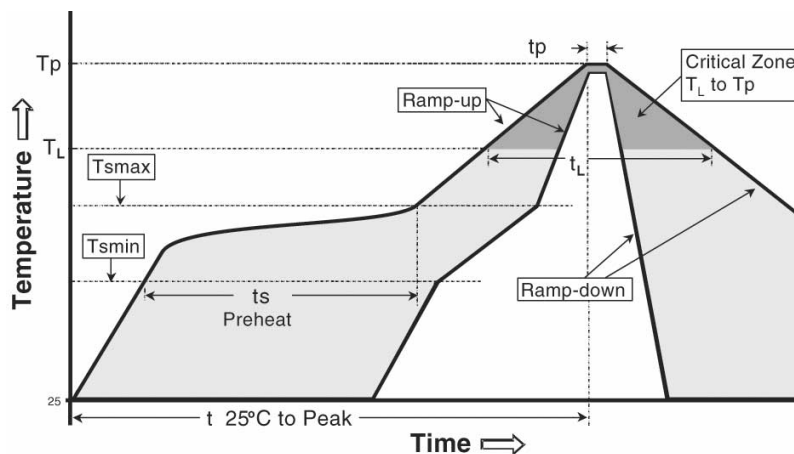

Figure 12 – Temperature profile

PACKAGING

The NANO mXTEND™ (NN02-101) antenna booster is delivered in tape and reel packaging.

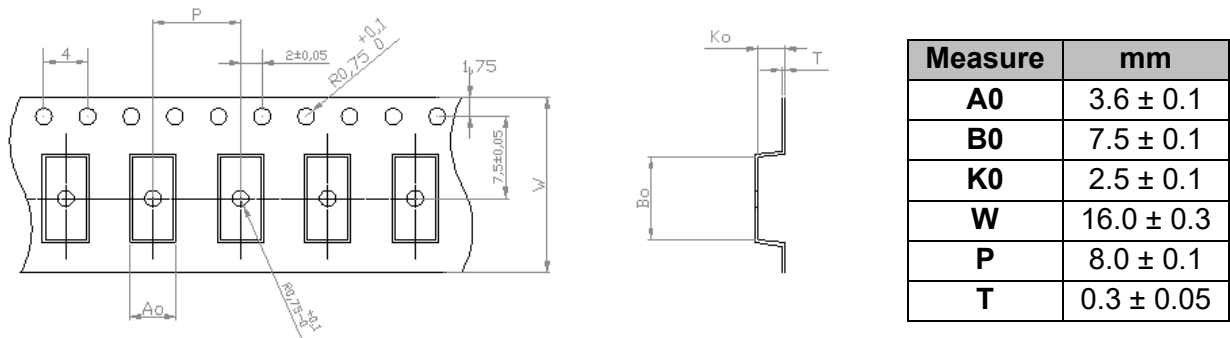

Figure 13 - Tape dimensions and tolerances.

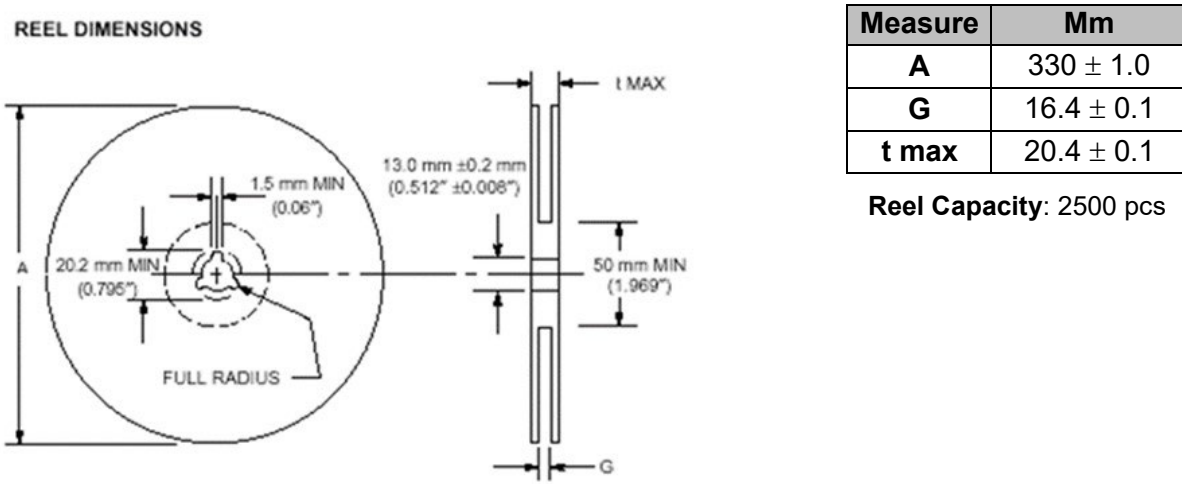

Figure 14 - Reel dimensions and capacity.

Ignion products and solutions are protected by [Ignion patents](#).

All information contained within this document is property of Ignion and is subject to change without prior notice. Information is provided “as is” and without warranties. The copy or reproduction of this information without prior approval is prohibited.

Ignion is an ISO 9001:2015 certified company. All our antennas are lead-free and RoHS compliant.

ISO 9001: 2015 Certified





Your innovation.
Accelerated.

Contact:

support@ignion.io

+34 935 660 710

Barcelona

Av. Alcalde Barnils, 64-68 Modul C, 3a pl.
Sant Cugat del Vallés
08174 Barcelona
Spain

Shenzhen

Topway Information Building, 2303 Room
No.3369, Binhai Avenue, Nanshan District
Shenzhen, Guangdong 518000
China

+86 138 2653 8470

Tampa

8875 Hidden River Parkway
Suite 300
Tampa, FL 33637
USA