

Solderless terminals

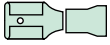

QUICK DISCONNECT Female, Vinyl-insulated with copper sleeve

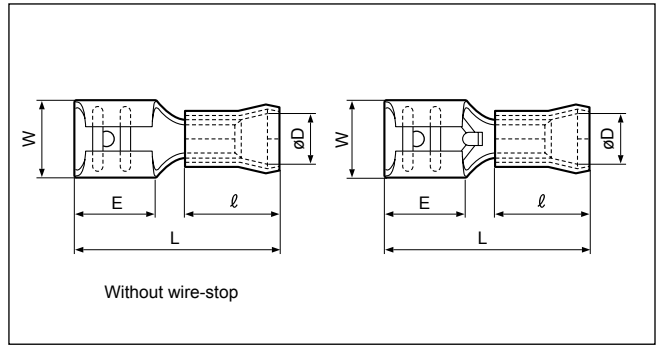
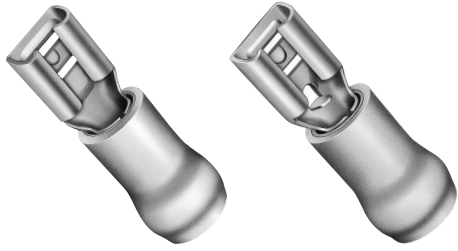
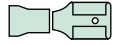

Certificate No.: E70188 LR20812

	Applicable Wire AWG#(mm ²)	Part No.	Standard	Dimensions mm (in.)						Material Thickness	Mating Tab Thickness	Color	Tool No.							Qty/box	
				W	L	E	ø D	ℓ	YNT-2622				YNT-2216	YNT-1614	YNT-1210S	YA-1	YA-2	YA-4	BCT-0514L		
110	26 to 22 (0.2 to 0.5)	FVDDF0.5-110A-5 *	 (Note 2)	3.7 (.146)	16.4 (.646)	6.4 (.252)	2.2 (.087)	8.0 (.315)	0.25(.010)	0.5 (.020)	Yellow	o			o	o	o	o	1,000		
		FVDDF0.5-110A-8 *		3.7 (.146)	16.4 (.646)	6.4 (.252)	2.2 (.087)	8.0 (.315)	0.25(.010)	0.8 (.031)											
187	22 to 16 (0.25 to 1.65)	FVDDF1.25-110A-5		3.7 (.146)	17.9 (.705)	6.4 (.252)	3.5 (.138)	9.5 (.374)	0.25(.010)	0.5 (.020)	Red		o			o	o	o	o	1,000	
		FVDDF1.25-110A-8		3.7 (.146)	17.9 (.705)	6.4 (.252)	3.5 (.138)	9.5 (.374)	0.25(.010)	0.8 (.031)											
		FVDDF1.25-187A-5		5.7 (.224)	18.7 (.736)	6.0 (.236)	3.5 (.138)	9.5 (.374)	0.35(.014)	0.5 (.020)											
		FVDDF1.25-187A-8		5.7 (.224)	18.7 (.736)	6.0 (.236)	3.5 (.138)	9.5 (.374)	0.35(.014)	0.8 (.031)											
187	16 to 14 (1.04 to 2.63)	FVDDF2-187A-5		5.7 (.224)	18.7 (.736)	6.0 (.236)	4.3 (.169)	9.5 (.374)	0.35(.014)	0.5 (.020)	Blue			o		o	o	o	o	1,000	
		FVDDF2-187A-8		5.7 (.224)	18.7 (.736)	6.0 (.236)	4.3 (.169)	9.5 (.374)	0.35(.014)	0.8 (.031)											
205	22 to 16 (0.25 to 1.65)	FVDDF1.25-205A-5 *		6.3 (.248)	18.7 (.736)	6.4 (.252)	3.5 (.138)	9.5 (.374)	0.4 (.016)	0.5 (.020)	Red	o				o	o	o	o	1,000	
		FVDDF1.25-205A-8 *		6.3 (.248)	18.7 (.736)	6.4 (.252)	3.5 (.138)	9.5 (.374)	0.4 (.016)	0.8 (.031)											
205	16 to 14 (1.04 to 2.63)	FVDDF2-205A-8 *		6.3 (.248)	18.7 (.736)	6.4 (.252)	4.3 (.169)	9.5 (.374)	0.4 (.016)	0.8 (.031)	Blue			o		o	o	o	o	1,000	
250	22 to 16 (0.25 to 1.65)	FVDDF1.25-250A		7.4 (.291)	20.5 (.807)	7.8 (.307)	3.5 (.138)	9.5 (.374)	0.4 (.016)	0.8 (.031)	Red	o				o	o	o	o	1,000	
	16 to 14 (1.04 to 2.63)	FVDDF2-250A		7.4 (.291)	20.5 (.807)	7.8 (.307)	4.3 (.169)	9.5 (.374)	0.4 (.016)	0.8 (.031)	Blue		o			o	o	o	o	1,000	
	12 to 10 (2.63 to 6.64)	FVDDF5.5-250A		7.4 (.291)	24.5 (.965)	7.8 (.307)	6.2 (.244)	13.5 (.531)	0.4 (.016)	0.8 (.031)	Yellow			o			o	o	o	500	
	22 to 16 (0.25 to 1.65)	FVDDF1.25-250B *		7.6 (.299)	20.5 (.807)	8.0 (.315)	3.5 (.138)	9.5 (.374)	0.45(.018)	0.8 (.031)	Red	o				o	o	o	o	1,000	
	16 to 14 (1.04 to 2.63)	FVDDF2-250B *		7.6 (.299)	20.5 (.807)	8.0 (.315)	4.3 (.169)	9.5 (.374)	0.45(.018)	0.8 (.031)	Blue		o			o	o	o	o	1,000	
	12 to 10 (2.63 to 6.64)	FVDDF5.5-250B *		7.6 (.299)	24.5 (.965)	8.0 (.315)	6.2 (.244)	13.5 (.531)	0.45(.018)	0.8 (.031)	Yellow			o			o	o	o	500	
375	16 to 14 (1.04 to 2.63)	FVDDF2-375A *		11.0 (.433)	25.2 (.992)	12.0 (.472)	4.3 (.169)	9.5 (.374)	0.5 (.020)	1.1 (.043)	Blue			o		o	o	o	o	500	
	12 to 10 (2.63 to 6.64)	FVDDF5.5-375A *		11.0 (.433)	29.2(1.150)	12.0 (.472)	6.2 (.244)	13.5 (.531)	0.5 (.020)	1.1 (.043)	Yellow			o			o	o	o	250	

Note: 1) Products marked with * are without wire-stop.
 2) It's applicable only AWG#22 for UL, CSA.
 3) Delivery lead times may vary depending on the product. Contact JST for details.

Solderless terminals

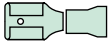

QUICK DISCONNECT Female, Vinyl-insulated with funnel-entry copper sleeve

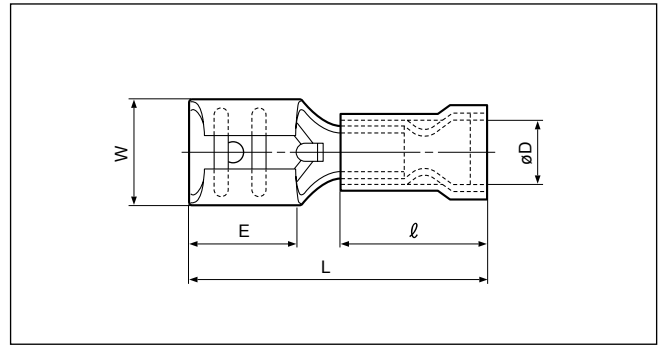
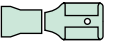

Certificate No.: E70188 LR20812

	Applicable Wire AWG#(mm ²)	Part No.	Standard	Dimensions mm (in.)						Material Thickness	Mating Tab Thickness	Color	Tool No.					Qty/box
				W	L	E	ø D	l	YNT-2216				YNT-1614	YA-1	YA-2	YA-4	BCT-0514L	
110	22 to 16 (0.25 to 1.65)	FVZDF1.25-110A-5		3.7 (.146)	19.4 (.764)	6.4 (.252)	3.6 (.142)	11.0 (.433)	0.25(.010)	0.5 (.020)	Red	o					1,000	
		FVZDF1.25-110A-8		3.7 (.146)	19.4 (.764)	6.4 (.252)	3.6 (.142)	11.0 (.433)	0.25(.010)	0.8 (.031)		o	o	o	o	o		
		FVZDF1.25-187A-8		5.7 (.224)	20.2 (.795)	6.0 (.236)	3.6 (.142)	11.0 (.433)	0.35(.014)	0.8 (.031)								
187	16 to 14 (1.04 to 2.63)	FVZDF2-187A-5		5.7 (.224)	20.2 (.795)	6.0 (.236)	4.3 (.169)	11.0 (.433)	0.35(.014)	0.5 (.020)	Blue		o	o	o	o	1,000	
		FVZDF2-187A-8		5.7 (.224)	20.2 (.795)	6.0 (.236)	4.3 (.169)	11.0 (.433)	0.35(.014)	0.8 (.031)		o	o	o	o			
250	22 to 16 (0.25 to 1.65)	FVZDF1.25-250A		7.4 (.291)	22.0 (.866)	7.8 (.307)	3.6 (.142)	11.0 (.433)	0.4 (.016)	0.8 (.031)	Red	o		o	o	o	1,000	
	16 to 14 (1.04 to 2.63)	FVZDF2-250A		7.4 (.291)	22.0 (.866)	7.8 (.307)	4.3 (.169)	11.0 (.433)	0.4 (.016)	0.8 (.031)		Blue	o	o	o	o		o

Note :1) Delivery lead times may vary depending on the product. Contact JST for details.

Solderless terminals

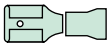

QUICK DISCONNECT Female, Fully-insulated with copper sleeve

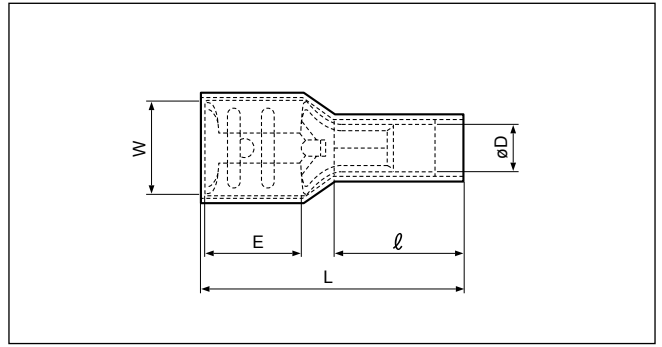
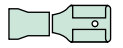

With straight insulation

Certificate No.: E70188 LR20812

	Applicable Wire AWG#(mm ²)	Part No.	Standard	Dimensions mm (in.)						Color	Tool No.						Qty/box		
				W	L	E	ø D	l	Material Thickness		Mating Tab Thickness	YNT-2216	YNT-1614	YNT-1210S	YA-1	YA-2		YA-4	BCT-0514L
187	22 to 16 (0.25 to 1.65)	LVDDF1.25-187A-5		5.7 (.224)	20.0 (.787)	6.0 (.236)	2.7 (.106)	11.0 (.433)	0.35(.014)	0.5 (.020)	Red	o			o	o	o	o	1,000
		LVDDF1.25-187A-8		5.7 (.224)	20.0 (.787)	6.0 (.236)	2.7 (.106)	11.0 (.433)	0.35(.014)	0.8 (.031)									
	16 to 14 (1.04 to 2.63)	LVDDF2-187A-5		5.7 (.224)	20.0 (.787)	6.0 (.236)	3.2 (.126)	11.0 (.433)	0.35(.014)	0.5 (.020)	Blue		o		o	o	o	o	1,000
		LVDDF2-187A-8		5.7 (.224)	20.0 (.787)	6.0 (.236)	3.2 (.126)	11.0 (.433)	0.35(.014)	0.8 (.031)									
250	22 to 16 (0.25 to 1.65)	LVDDF1.25-250A		7.4 (.291)	22.0 (.866)	7.8 (.307)	2.7 (.106)	11.0 (.433)	0.4 (.016)	0.8 (.031)	Red	o			o	o	o	o	500
	16 to 14 (1.04 to 2.63)	LVDDF2-250A		7.4 (.291)	22.0 (.866)	7.8 (.307)	3.2 (.126)	11.0 (.433)	0.4 (.016)	0.8 (.031)	Blue		o		o	o	o	o	500
	12 to 10 (2.63 to 6.64)	LVDDF5.5-250A		7.4 (.291)	25.0 (.984)	7.8 (.307)	4.5 (.177)	14.0 (.551)	0.4 (.016)	0.8 (.031)	Yellow			o			o	o	500

Note:1) Delivery lead times may vary depending on the product. Contact JST for details.

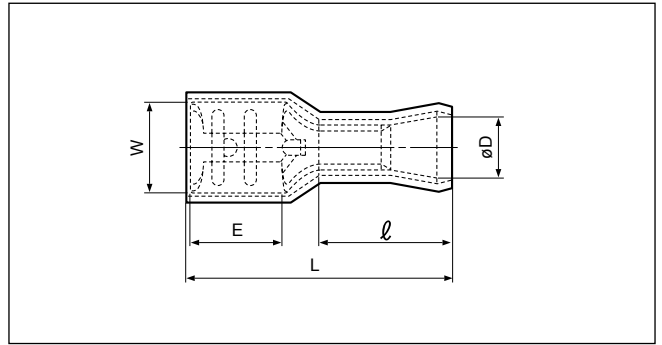

With flared insulation

Certificate No.: E70188 LR20812

	Applicable Wire AWG#(mm ²)	Part No.	Standard	Dimensions mm (in.)						Color	Tool No.						Qty/box		
				W	L	E	ø D	l	Material Thickness		Mating Tab Thickness	YNT-2216	YNT-1614	YNT-1210S	YA-1	YA-2		YA-4	BCT-0514L
187	22 to 16 (0.25 to 1.65)	FLVDDF1.25-187A-5		5.7 (.224)	19.0 (.748)	6.0 (.236)	3.5 (.138)	9.5 (.374)	0.35(.014)	0.5 (.020)	Red	o			o	o	o	o	1,000
		FLVDDF1.25-187A-8		5.7 (.224)	19.0 (.748)	6.0 (.236)	3.5 (.138)	9.5 (.374)	0.35(.014)	0.8 (.031)									
	16 to 14 (1.04 to 2.63)	FLVDDF2-187A-5		5.7 (.224)	19.0 (.748)	6.0 (.236)	4.3 (.169)	9.5 (.374)	0.35(.014)	0.5 (.020)	Blue		o		o	o	o	o	1,000
		FLVDDF2-187A-8		5.7 (.224)	19.0 (.748)	6.0 (.236)	4.3 (.169)	9.5 (.374)	0.35(.014)	0.8 (.031)									
250	22 to 16 (0.25 to 1.65)	FLVDDF1.25-250A		7.4 (.291)	21.0 (.827)	7.8 (.307)	3.5 (.138)	9.5 (.374)	0.4 (.016)	0.8 (.031)	Red	o			o	o	o	o	500
	16 to 14 (1.04 to 2.63)	FLVDDF2-250A		7.4 (.291)	21.0 (.827)	7.8 (.307)	4.3 (.169)	9.5 (.374)	0.4 (.016)	0.8 (.031)	Blue		o		o	o	o	o	500

Note:1) Delivery lead times may vary depending on the product. Contact JST for details.

Solderless terminals

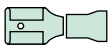

QUICK DISCONNECT Female, Fully-insulated with funnel-entry copper sleeve

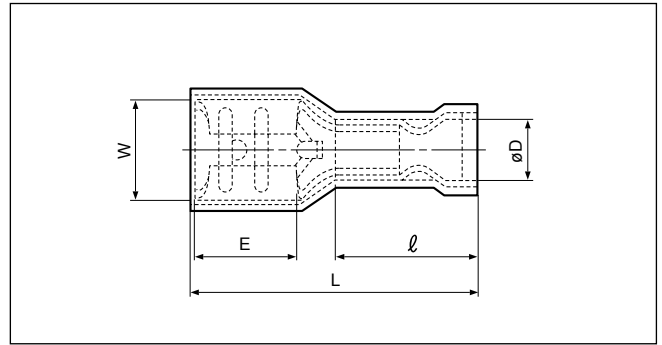
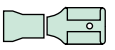

Certificate No.: E70188 LR20812

	Applicable Wire AWG#(mm ²)	Part No.	Standard	Dimensions mm (in.)						Material Thickness	Mating Tab Thickness	Color	Tool No.					Qty/box
				W	L	E	ø D	l	YNT-2216				YNT-1614	YA-1	YA-2	YA-4	BCT-0514L	
187	22 to 16 (0.25 to 1.65)	FLVZDF1.25-187A-5		5.7 (.224)	20.5 (.807)	6.0 (.236)	3.6 (.142)	11.0 (.433)	0.35(.014)	0.5 (.020)	Red	o	o	o	o	o	1,000	
		FLVZDF1.25-187A-8		5.7 (.224)	20.5 (.807)	6.0 (.236)	3.6 (.142)	11.0 (.433)	0.35(.014)	0.8 (.031)								
	16 to 14 (1.04 to 2.63)	FLVZDF2-187A-5		5.7 (.224)	20.5 (.807)	6.0 (.236)	4.3 (.169)	11.0 (.433)	0.35(.014)	0.5 (.020)	Blue	o	o	o	o	o	1,000	
250	22 to 16 (0.25 to 1.65)	FLVZDF1.25-250A		7.4 (.291)	22.5 (.886)	7.8 (.307)	3.6 (.142)	11.0 (.433)	0.4 (.016)	0.8 (.031)	Red	o	o	o	o	o	500	
		FLVZDF2-250A		7.4 (.291)	22.5 (.886)	7.8 (.307)	4.3 (.169)	11.0 (.433)	0.4 (.016)	0.8 (.031)								
	16 to 14 (1.04 to 2.63)	FLVZDF2-250A		7.4 (.291)	22.5 (.886)	7.8 (.307)	4.3 (.169)	11.0 (.433)	0.4 (.016)	0.8 (.031)	Blue	o	o	o	o	o	500	

Note:1) Delivery lead times may vary depending on the product. Contact JST for details.

Solderless terminals

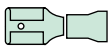

QUICK DISCONNECT Male, Vinyl-insulated with copper sleeve

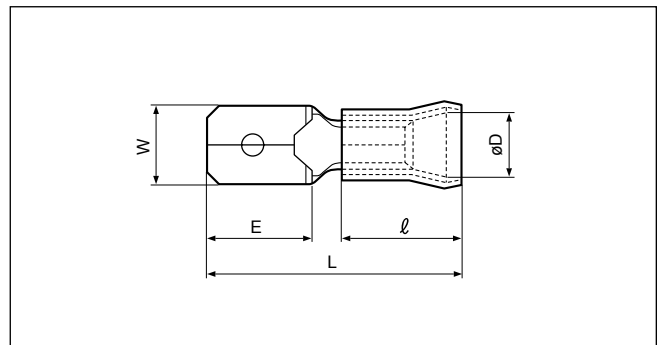
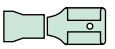

Certificate No.: E70188 LR20812

	Applicable Wire AWG#(mm ²)	Part No.	Standard	Dimensions mm (in.)						Material Thickness	Mating Tab Thickness	Color	Tool No.					Qty/box
				W	L	E	ø D	l	YNT-2216				YNT-1614	YNT-1210S	YA-1	YA-2	YA-4	
260	22 to 16 (0.25 to 1.65)	FVDDM1.25-250		6.3 (.248)	20.5 (.807)	8.0 (.315)	3.5 (.138)	9.5 (.374)	0.4 (.016)	0.8 (.031)	Red	o	o	o	o	o	1,000	
	16 to 14 (1.04 to 2.63)	FVDDM2-250		6.3 (.248)	20.5 (.807)	8.0 (.315)	4.3 (.169)	9.5 (.374)	0.4 (.016)	0.8 (.031)		Blue	o	o	o	o		o
	12 to 10 (2.63 to 6.64)	FVDDM5.5-250		6.3 (.248)	24.5 (.965)	8.5 (.335)	6.2 (.244)	13.5 (.531)	0.4 (.016)	0.8 (.031)	Yellow	o	o	o	o	o	500	

Note:1) Delivery lead times may vary depending on the product. Contact JST for details.

Solderless terminals

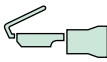

PIGGYBACK Vinyl-insulated with copper sleeve

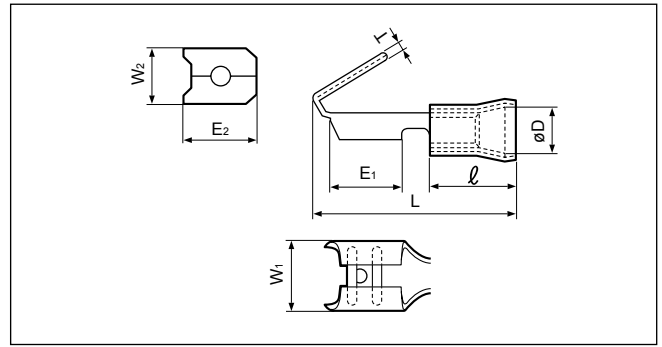
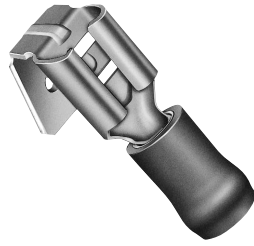
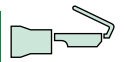

Certificate No.: E70188 LR20812

	Applicable Wire AWG#(mm ²)	Part No.	Standard	Dimensions mm (in.)									Color	Tool No.					Qty/box	
				W		L	E		ø D	ℓ	Material Thickness	T		YNT-2216	YNT-1614	YA-1	YA-2	YA-4		BCT-0514L
				W ₁	W ₂		E ₁	E ₂												
250	22 to 16 (0.25 to 1.65)	FVDDFM1.25-250A		7.4 (.291)	6.3 (.248)	22.2 (.874)	7.8 (.307)	8.0 (.315)	3.5 (.138)	9.5 (.374)	0.4 (.016)	0.8 (.031)	Red	o	o	o	o	o	500	
	16 to 14 (1.04 to 2.63)	FVDDFM2-250A		7.6 (.299)	6.3 (.248)	22.0(.866)	7.8 (.307)	8.0 (.315)	4.3 (.170)	9.5 (.374)	0.4 (.016)	0.8 (.031)	Blue	o	o	o	o	o	500	
		FVDDFM2-250B		7.4 (.291)		22.2(.874)														

Note:1) Terminals FVDDFM2-250A have no slits in the receptacle part.
 2) Delivery lead times may vary depending on the product. Contact JST for details.