



Technical Data Sheet

Alpha 10



File No. E471457



Alpha 10 is a compact multifunction instrument which measures important electrical parameters in 3 phase 4 Wire and 3 phase 3 Wire Network & replaces multiple analog panel meters

Special Features

- 3 Line 4 Digits ultra bright LED Display (upto 9999)
- On site Programmable CT/PT Ratios
- User selectable CT Secondary 1A/5A
- User selectable 3ph 3wire / 3ph 4wire /single phase Network
- Storage of MIN / MAX values
- Measurement & Display of RPM, Run hours, On hours & No. of Interrupts

Application

Alpha 10 measures important electrical parameters in 3 phase 4 Wire and 3 phase 3 Wire Network & replaces the multiple analog panel meters. It measures electrical parameters like AC Voltage, AC Current, & many more.

Product Features

On site programmable PT/CT ratios	It is possible to program primary of the external potential Transformer (PT), primary of external Current Transformer (CT) on site via front panel keys by entering into Programming mode.	Onsite selection of Auto scroll / Fixed Screen	User can set the display in auto scrolling mode or fixed screen mode using front panel keys.
User selectable CT Secondary 5A / 1A	The secondary of external Current Transformer (CT) can be programmed on site to either 5A or 1A using front panel keys.	Low back depth	The instrument has very low back depth (behind the panel) of less than 55mm (without output options).
User selectable PT Secondary	The secondary of external Potential Transformer (PT) can be programmed on site from 100VLL to 500VLL using front panel keys.	True RMS measurement	The instrument measures distorted waveform up to 15th Harmonic.
User selectable 3 phase 3Wire 4Wire or Single phase Network	User can program on site the network connection as either 3 Phase 3 Wire/4 Wire or single phase network using front panel keys. In case of self powered configuration either 3 Phase 4 wire or single phase network are available.	EMC Compatibility	Compliance to International standard IEC 61326. Interference Emission IEC 61326-1 : 2005, Class, A Interference Immunity IEC 61326-1 : 2005 Electrostatic discharge IEC 61000-4-2 -- 4kV/8kV contact/air. (ESD)
RPM Measurement	The instrument display Rotation per minutes for generator applications. Number of poles can be set on site depending upon application requirement.	EM Field	IEC 61000-4-3 -- 10 V/m (80 MHz to 1 GHz) -- 3 V/m (1.4 GHz to 2 GHz) -- 1 V/m (2 GHz to 2.7 GHz)
Optional Limit switch (Relay)	The instrument will trip the relay if the programmed parameter exceeds the programmed Trip Limits.	Burst	IEC 61000-4-4 -- 2 kV (5/50 ns, 5 kHz)
3 line 4 digits LED display	Simultaneous display of 3 Parameters.	Surge	IEC 61000-4-5 -- 1 kVLL / 2 kVLN.
Enclosure Protection for dust and water	Conforms to IP 50 (for front face) or IP 65 option (for front with seal) & IP 20 (for back) & as per IEC60529.	Conducted RF	IEC 61000-4-5 -- 3 V (150 kHz to 80 MHz)
Storage of parameters possible	The instrument stores minimum and maximum values for System Voltage, System Current, Run Hour, ON Hour & number of Interrupts. Every 60 sec stored values are updated.	Rated Power Frequency magnetic Field	IEC 61000-4-8 -- 30 A/m
Four function keys	Using the four function key, it is possible to go desired parameter screen instantly.	Voltage dip	IEC 61000-4-1 40% during 10/12 cycles. 70% during 25/30 cycles.
		Short interruptions	IEC 61000-4-11 0% during 25/30 cycles. 25 cycles for 50 Hz test. 30 cycles for 60 Hz test.

Technical Specifications

Reference conditions for Accuracy

Reference temperature	23°C +/- 2°C
Input waveform	Sinusoidal (distortion factor 0.005)
Input frequency	50 or 60 Hz ±2%
Auxiliary supply voltage	Rated Value ±1%
Auxiliary supply frequency	Rated Value ±1%

Accuracy

Voltage	±1% of range (20... 100% of Nominal value)
Current	±1% of range (10... 100% of Nominal value)
Frequency	0.5% of mid frequency

Input Voltage

Nominal input voltage (AC RMS)	Phase -Neutral 290V L-N , Line-Line 500V L-L
Max continuous input voltage	120% of rated value
Nominal input voltage burden	< 0.3 VA approx. per phase (For external auxiliary meter)
System PT secondary values	100VLL to 500VLL programmable on site.
System PT primary values	100VLL to 692kVLL programmable on site.

Input Current

Nominal input current	5A AC RMS
System CT secondary values	1A & 5A programmable on site
System CT primary values	From 1A up to 9999A (for 1 or 5 Amp)
Max continuous input current	120% of rated value
Nominal input current burden	< 0.2 VA approx. per phase

Auxiliary Supply

External Aux	40 V - 300V AC-DC (± 5 %)
Self powered	Input voltage range from 80% to 100% of Rated value. (Self powered meter is available only in 3Phase 4 Wire and Single Phase network.) Auxiliary input is derived from Phase 1 (R phase)
Frequency range	45 to 65 Hz
VA burden	3 VA Approx.

Dimension Details

With optional Limit switch

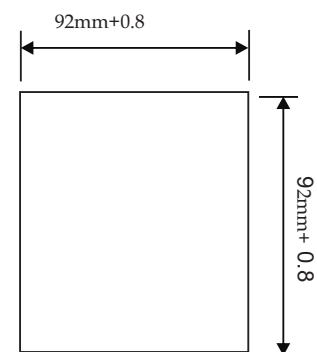
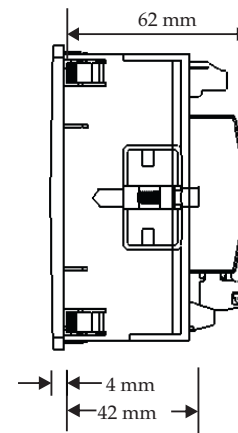
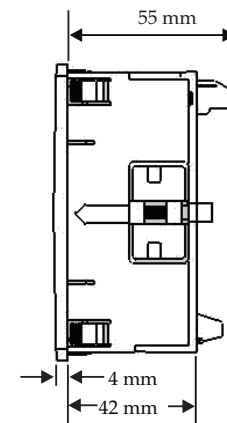
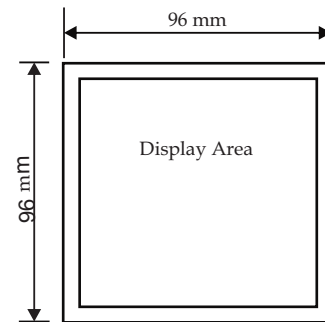

Panel Cutout

Technical Specifications

Overload Withstand

Voltage	2 x rated value for 1 second, repeated 10 times at 10 second intervals
Current	20x rated value for 1 second, repeated 5 times at 5 min intervals

Operating Measuring Ranges

Voltage Range With External Aux	10... 120% of rated value
Voltage Range With Self Power	80... 120% of rated value
Current Range	10 ... 120% of rated value
Frequency	45...65 Hz

Influence of Variations

Temperature coefficient	0.025%/°C for Voltage 0.05%/°C for Current
-------------------------	---

Limit Switch (Relay)

Switching Voltage & Current for Relay	240 VDC ,5 A (INO+INC)
---------------------------------------	------------------------

Enclosure

Front	IP 50
Front with seal (Option)	IP 65
Back	IP 20

Environmental

Operating temperature	-20° to +70°C
Storage temperature	-30°C to +80°C
Relative humidity	0 to 95% non condensing
Warm up time	Minimum 3 minute
Shock	15g in 3 planes
Vibration	10... 55 Hz, 0.15mm amplitude

Safety

Pollution degree	2
Installation category	III
High Voltage Test	3.3 kV AC, 50Hz for 1 minute between Aux. and measuring inputs

Applicable Standards

EMC	IEC 61326-1: 2005
Safety	IEC 61010-1-2001 , Permanently connected use
IP for water & dust	IEC60529

Installation

Easy Clip in Installation on Panel

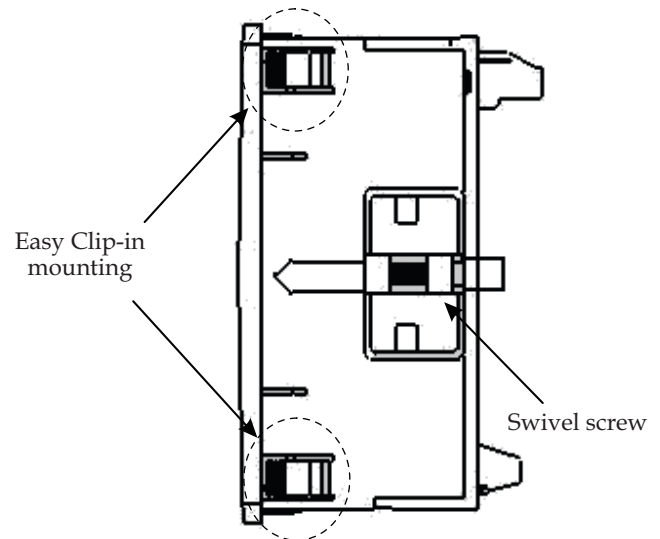

Panel Thickness : 1 - 3 mm for self clicking,
1 - 6 mm for swivel screws.

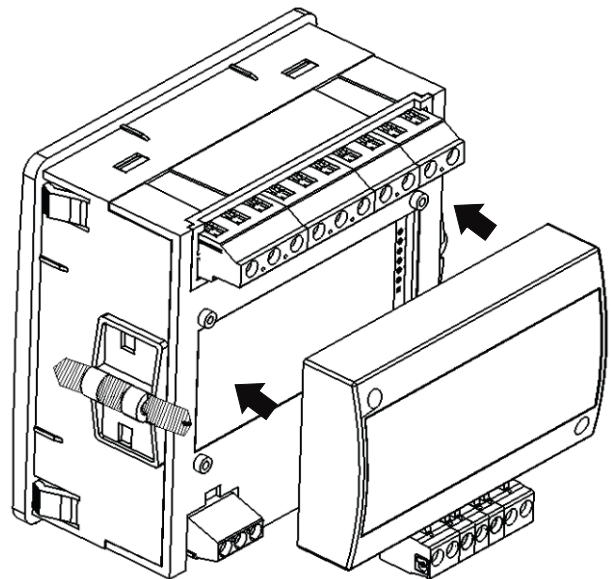

Optional Limit Switch pluggable module.

Technical Specifications

Dimensions and Weight

Bezel size	96 mm x 96 mm DIN 43 718.
Panel cut-out	92 +0.8 mm x 92 + 0.8 mm.
Overall depth	55 mm (without output options) 62 mm (with output options).
Panel Thickness	1 - 3 mm for self clicking, 1 - 6 mm for swivel screws.
Weight	320 gm. Approx (with output options)..

Rear Connection

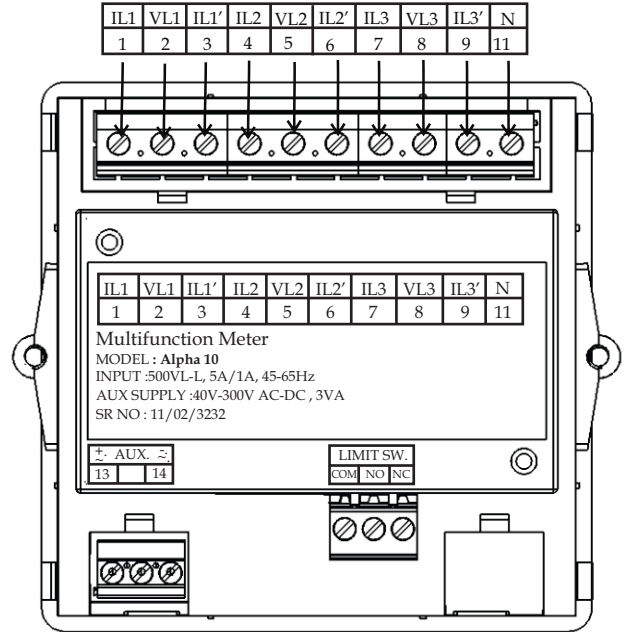

Electrical Connections

	Self Powered Aux	External Powered Aux
3 Phase 4 Wire Unbalanced Load		
3 Phase 3 Wire Unbalanced Load	Not Applicable	
1 Phase 2 Wire		

*Note: For Measurement of parameters, Voltage must be present between terminal 2 & 11 for single phase or 3 phase 4 wire network and between terminal 2 & 5 or 2 & 8 for 3 phase 3 wire network.

Electrical Parameters

Sr No	Parameter	3 Phase 4 Wire	3 Phase 3 Wire	1 Phase 2 Wire
1	System Volts	✓	✓	✓
2	System Current	✓	✓	✓
3	Frequency	✓	✓	✓
4	Volts R-N	✓	✗	✓
5	Volts Y-N	✓	✗	✗
6	Volts B-N	✓	✗	✗
7	Volts R-Y	✓	✓	✗
8	Volts Y-B	✓	✓	✗
9	Volts B-R	✓	✓	✗
10	Current R	✓	✓	✓
11	Current Y	✓	✓	✗
12	Current B	✓	✓	✗
13	RPM	✓	✓	✓
14	Max (System Voltage / System Current)	✓	✓	✓
15	Min (System Voltage / System Current)	✓	✓	✓
16	Hour Run	✓	✓	✓
17	ON Hour	✓	✓	✓
18	Number of auxiliary interrupt	✓	✓	✓

Ordering information

Product Code	AP10-	X	X	X	XX	X	0000000
Display Type	3 Line	3					
	1 Line (20mm display)	1					
System Type	3 Ph. (PR. 3W or 4W)		3				
	1 Ph.		1				
Input Voltage / Current	100 TO 500VL-L 1/5A			1			
Power Supply	*Self Aux					SA	
	40 V - 300 U					EA	
	12-48 V DC					LA	
Limit switch	* With Limit switch						L
	Without Limit switch						Z



sifam tinsley
PRECISION INSTRUMENTATION

Sifam Tinsley Instrumentation Inc.
3105, Creekside Village Drive,
Suite No. 801, Kennesaw,
Georgia 30144 (USA)
E-mail Id : psk@sifamtinsley.com
Web : www.sifamtinsley.com
Contact No. : +1 404 736 4903

Sifam Tinsley Instrumentation Ltd
Unit 1 Warner Drive,
Springwood Industrial Estate
Braintree, Essex, UK, CM72YW
E-mail: sales@sifamtinsley.com
Web: www.sifamtinsley.com/uk
Contact: +44(0)1803615139