

SUMMARY

Wires

Low voltage 4



Image is for illustrative purpose only

Series	2P
Termination type	Female crimp
IP rating	50
AWG wire size	28.00 - 20.00
Cable Ø	3.20 - 9.20 mm
Status	active
Matching parts	CAB.M04.GYC.C92G

Download

[Request a quote](#)

[Catalog](#)

TECHNICAL DETAILS

Mechanics

Shell Style/Model	CK*: Fixed receptacle with two nuts (back panel mounting)
Keying	3 keys (alpha=0, gamma=60; Plug: male contacts; Receptacle: female contacts)
Housing Material	PSU (Polysulfone), gray
Weight	5.85 g

Performance

Configuration	2P.M04 : 4 Low V.
Insulator	Y: PEEK for crimp contacts
Rated Current	15 Amps

Specifications

Test voltage (kV rms) Contact-contact: 1.85
Air clearance min.: 2.25 mm
Creepage distance min.: 2.25 mm

Others

Endurance (Shell): >1000 mating cycles
F ret (min): 150 N
F ret (max): 250 N

LEMO products and services are provided "as is". LEMO makes no warranties or representations with regard to LEMO product & services or use of them, express, implied or statutory, including for accuracy, completeness, or security. The user is fully responsible for his products and applications using LEMO components.

DRAWINGS

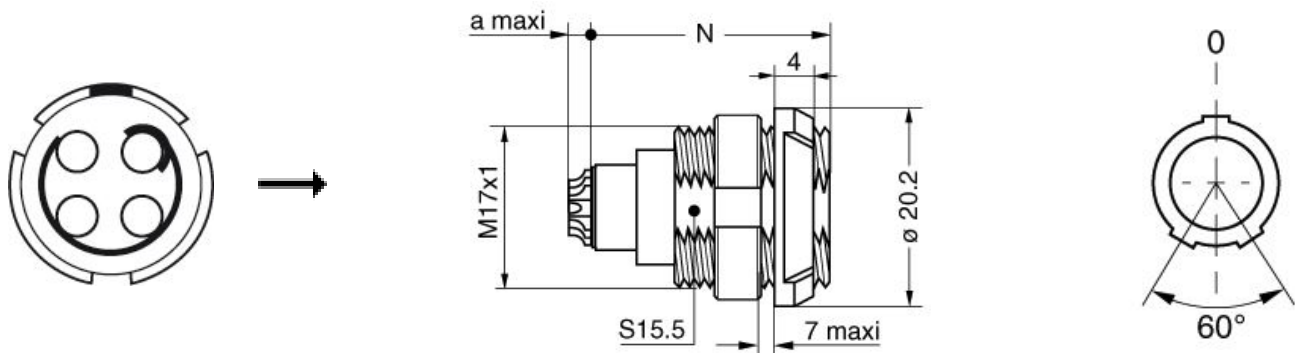

Dimensions

	A	N	a
mm.	20.2	25.1	0
in.	0,80	0,99	0,00

RECOMMENDED BY LEMO















Tools

Crimp Tool:	DPC.91.701.V
Crimp settings:	AWG/Selector = 18-20/8-7
Positionner:	DCE.91.132.BVM
Extractor:	DCF.91.131.2LT
Replacement contact:	EGG.2B.665.ZZM

Cables

CMN.04.T20.053PGZE		Grey	
CMN.04.T20.053PNZE			

LEMO products and services are provided "as is". LEMO makes no warranties or representations with regard to LEMO product & services or use of them, express, implied or statutory, including for accuracy, completeness, or security. The user is fully responsible for his products and applications using LEMO components.

CMN.04.T20.053QGZE	TPR (medical)	Grey	
CMN.04.T22.047QGC	TPR	Grey	
CMN.04.T22.048QGZE	TPR (medical)	Grey	
140240	PVC	Black	
140250	PVC	Grey	
240500	PVC	Grey	
240750	PVC	Grey	
40080	PVC	Black	
40086	PVC	Blue	
40140	PVC	Black	
40240	PTFE	White	
40260	PVC	Black	
4080	PVC	Grey	
417920	PVC	Grey	
4220	PVC	Black	
4221	PVC	Black	
4260	PTFE	White	
4280	PVC	Black	
80080	PVC	Grey	
80082	PVC	Red	
80084	PVC	Black	
CTR.75.030.121870G	PVC	Grey	

LEMO products and services are provided "as is". LEMO makes no warranties or representations with regard to LEMO product & services or use of them, express, implied or statutory, including for accuracy, completeness, or security. The user is fully responsible for his products and applications using LEMO components.