

# MOSFET – N-Channel, DUAL COOL<sup>®</sup> 33, POWERTRENCH<sup>®</sup> 30 V, 157 A, 1.28 mΩ

## FDMC8010DC

### General Description

This N-Channel MOSFET is produced using onsemi's advanced POWERTRENCH process. Advancements in both silicon and DUAL COOL package technologies have been combined to offer the lowest  $r_{DS(on)}$  while maintaining excellent switching performance by extremely low Junction-to-Ambient thermal resistance.

### Features

- DUAL COOL Top Side Cooling PQFN Package
- Max  $r_{DS(on)}$  = 1.28 mΩ at  $V_{GS} = 10\text{ V}$ ,  $I_D = 37\text{ A}$
- Max  $r_{DS(on)}$  = 1.74 mΩ at  $V_{GS} = 4.5\text{ V}$ ,  $I_D = 32\text{ A}$
- High Performance Technology for Extremely Low  $r_{DS(on)}$
- These Devices are Pb-Free and are RoHS Compliant

### Applications

- Load Switch
- Motor Bridge Switch
- Synchronous Rectifier

### MOSFET MAXIMUM RATINGS ( $T_A = 25^\circ\text{C}$ Unless Otherwise Noted)

Symbol	Parameter	Ratings	Units
$V_{DS}$	Drain to Source Voltage	30	V
$V_{GS}$	Gate to Source Voltage (Note 4)	$\pm 20$	V
$I_D$	Drain Current		A
	–Continuous $T_C = 25^\circ\text{C}$ (Note 6)	157	
	–Continuous $T_C = 100^\circ\text{C}$ (Note 6)	99	
	–Continuous $T_A = 25^\circ\text{C}$ (Note 1a)	37	
	–Pulsed (Note 5)	788	
EAS	Single Pulse Avalanche Energy (Note 3)	337	mJ
$P_D$	Power Dissipation $T_C = 25^\circ\text{C}$	50	W
	Power Dissipation $T_A = 25^\circ\text{C}$ (Note 1a)	3.0	
$T_J, T_{STG}$	Operating and Storage Junction Temperature Range	-55 to +150	$^\circ\text{C}$

Stresses exceeding those listed in the Maximum Ratings table may damage the device. If any of these limits are exceeded, device functionality should not be assumed, damage may occur and reliability may be affected.

### THERMAL CHARACTERISTICS

Symbol	Parameter	Ratings	Unit
$R_{\theta JC}$	Thermal Resistance, Junction to Case (Bottom Drain)	2.5	$^\circ\text{C}/\text{W}$
$R_{\theta JA}$	Thermal Resistance, Junction to Ambient (Note 1a)	42	



PQFN8 3.3X3.3, 0.65P  
CASE 483AY  
DUAL COOL 33

### MARKING DIAGRAM

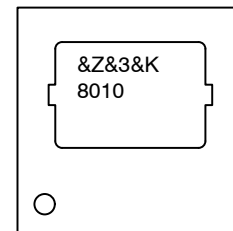

- &Z = Assembly Plant Code
- &3 = Numeric Date Code
- &K = Lot Code
- 8010 = Specific Device Code

### PIN CONNECTIONS

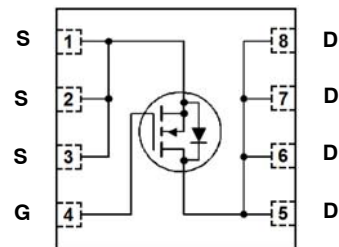

### ORDERING INFORMATION

See detailed ordering, marking and shipping information in the package dimensions section on page 2 of this data sheet.

# FDMC8010DC

## PACKAGE MARKING AND ORDERING INFORMATION

Device	Device Marking	Package	Reel Size	Tape Width	Quantity
FDMC8010DC	8010	DUAL COOL 33	13"	12 mm	3000 Units

## ELECTRICAL CHARACTERISTICS (T<sub>J</sub> = 25°C unless otherwise noted)

Symbol	Parameter	Test Condition	Min	Typ	Max	Unit
--------	-----------	----------------	-----	-----	-----	------

### OFF CHARACTERISTICS

BV <sub>DSS</sub>	Drain to Source Breakdown Voltage	I <sub>D</sub> = 250 μA, V <sub>GS</sub> = 0 V	30			V
ΔBV <sub>DSS</sub> /ΔT <sub>J</sub>	Breakdown Voltage Temperature Coefficient	I <sub>D</sub> = 250 μA, referenced to 25°C		15		mV/°C
I <sub>DSS</sub>	Zero Gate Voltage Drain Current	V <sub>DS</sub> = 24 V, V <sub>GS</sub> = 0 V			10	μA
I <sub>GSS</sub>	Gate to Source Leakage Current	V <sub>GS</sub> = 20 V, V <sub>DS</sub> = 0 V			100	nA

### ON CHARACTERISTICS

V <sub>GS(th)</sub>	Gate to Source Threshold Voltage	V <sub>GS</sub> = V <sub>DS</sub> , I <sub>D</sub> = 250 μA	1.0	1.4	3.0	V
ΔV <sub>GS(th)</sub> /ΔT <sub>J</sub>	Gate to Source Threshold Voltage Temperature Coefficient	I <sub>D</sub> = 250 μA, referenced to 25°C		-5		mV/°C
r <sub>DS(on)</sub>	Static Drain to Source On Resistance	V <sub>GS</sub> = 10 V, I <sub>D</sub> = 37 A		0.91	1.28	mΩ
		V <sub>GS</sub> = 4.5 V, I <sub>D</sub> = 32 A		1.2	1.74	
		V <sub>GS</sub> = 10 V, I <sub>D</sub> = 37 A, T <sub>J</sub> = 125°C		1.34	1.89	
g <sub>FS</sub>	Forward Transconductance	V <sub>DS</sub> = 5 V, I <sub>D</sub> = 37 A		231		S

### DYNAMIC CHARACTERISTICS

C <sub>iss</sub>	Input Capacitance	V <sub>DS</sub> = 15 V, V <sub>GS</sub> = 0 V, f = 1 MHz		4720	7080	pF
C <sub>oss</sub>	Output Capacitance			1540	2310	pF
C <sub>rss</sub>	Reverse Transfer Capacitance			136	205	pF
R <sub>g</sub>	Gate Resistance		0.1	0.5	1.1	Ω

### SWITCHING CHARACTERISTICS

t <sub>d(on)</sub>	Turn-On Delay Time	V <sub>DD</sub> = 15 V, I <sub>D</sub> = 37 A, V <sub>GS</sub> = 10 V, R <sub>GEN</sub> = 6 Ω		15	26	ns
t <sub>r</sub>	Rise Time			7	14	ns
t <sub>d(off)</sub>	Turn-Off Delay Time			40	64	ns
t <sub>f</sub>	Fall Time			5	10	ns
Q <sub>g(TOT)</sub>	Total Gate Charge at 10 V	V <sub>DD</sub> = 15 V I <sub>D</sub> = 37 A		67	94	nC
Q <sub>g(TOT)</sub>	Total Gate Charge at 4.5 V			32	44	nC
Q <sub>gs</sub>	Total Gate Charge			10		nC
Q <sub>gd</sub>	Gate to Drain "Miller" Charge			7.5		nC

### DRAIN-SOURCE DIODE CHARACTERISTICS

V <sub>SD</sub>	Source to Drain Diode Forward Voltage	V <sub>GS</sub> = 0 V, I <sub>S</sub> = 2.3 A (Note 2)		0.7	1.2	V
		V <sub>GS</sub> = 0 V, I <sub>S</sub> = 37 A (Note 2)		0.8	1.3	
t <sub>rr</sub>	Reverse Recovery Time	I <sub>F</sub> = 37 A, di/dt = 100 A/μs		55	88	ns
Q <sub>rr</sub>	Reverse Recovery Charge			48	76	nC

# FDMC8010DC

## THERMAL CHARACTERISTICS

$R_{\theta JC}$	Thermal Resistance, Junction to Case (Top Source)	5.0	°C/W
$R_{\theta JC}$	Thermal Resistance, Junction to Case (Bottom Drain)	2.5	
$R_{\theta JA}$	Thermal Resistance, Junction to Ambient (Note 1a)	42	
$R_{\theta JA}$	Thermal Resistance, Junction to Ambient (Note 1b)	105	
$R_{\theta JA}$	Thermal Resistance, Junction to Ambient (Note 1c)	29	
$R_{\theta JA}$	Thermal Resistance, Junction to Ambient (Note 1d)	40	
$R_{\theta JA}$	Thermal Resistance, Junction to Ambient (Note 1e)	19	
$R_{\theta JA}$	Thermal Resistance, Junction to Ambient (Note 1f)	23	
$R_{\theta JA}$	Thermal Resistance, Junction to Ambient (Note 1g)	30	
$R_{\theta JA}$	Thermal Resistance, Junction to Ambient (Note 1h)	79	
$R_{\theta JA}$	Thermal Resistance, Junction to Ambient (Note 1i)	17	
$R_{\theta JA}$	Thermal Resistance, Junction to Ambient (Note 1j)	26	
$R_{\theta JA}$	Thermal Resistance, Junction to Ambient (Note 1k)	12	
$R_{\theta JA}$	Thermal Resistance, Junction to Ambient (Note 1l)	16	

### NOTES:

- $R_{\theta JA}$  is determined with the device mounted on a 1 in<sup>2</sup> pad 2 oz copper pad on a 1.5 x 1.5 in. board of FR-4 material.  $R_{\theta JC}$  is guaranteed by design while  $R_{\theta CA}$  is determined by the user's board design.

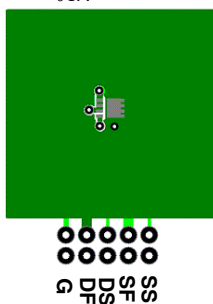

a. 42°C/W when mounted on a 1 in<sup>2</sup> pad of 2 oz copper

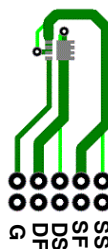

b. 105°C/W when mounted on a minimum pad of 2 oz copper

- Still air, 20.9x10.4x12.7 mm Aluminum Heat Sink, 1 in<sup>2</sup> pad of 2 oz copper.
  - Still air, 20.9x10.4x12.7 mm Aluminum Heat Sink, minimum pad of 2 oz copper.
  - Still air, 45.2x41.4x11.7 mm Aavid Thermalloy Part # 10-L41B-11 Heat Sink, 1 in<sup>2</sup> pad of 2 oz copper.
  - Still air, 45.2x41.4x11.7 mm Aavid Thermalloy Part # 10-L41B-11 Heat Sink, minimum pad of 2 oz copper.
  - 200FPM Airflow, No Heat Sink, 1 in<sup>2</sup> pad of 2 oz copper.
  - 200FPM Airflow, No Heat Sink, minimum pad of 2 oz copper.
  - 200FPM Airflow, 20.9x10.4x12.7 mm Aluminum Heat Sink, 1 in<sup>2</sup> pad of 2 oz copper.
  - 200FPM Airflow, 20.9x10.4x12.7 mm Aluminum Heat Sink, minimum pad of 2 oz copper.
  - 200FPM Airflow, 45.2x41.4x11.7 mm Aavid Thermalloy Part # 10-L41B-11 Heat Sink, 1 in<sup>2</sup> pad of 2 oz copper.
  - 200FPM Airflow, 45.2x41.4x11.7 mm Aavid Thermalloy Part # 10-L41B-11 Heat Sink, minimum pad of 2 oz copper.
- Pulse Test: Pulse Width < 300  $\mu$ s, Duty cycle < 2.0%.
  - $E_{AS}$  of 337 mJ is based on starting  $T_J = 25^\circ\text{C}$ ,  $L = 3$  mH,  $I_{AS} = 15$  A,  $V_{DD} = 30$  V,  $V_{GS} = 10$  V, 100% test at  $L = 0.1$  mH,  $I_{AS} = 49$  A.
  - As an N-ch device, the negative  $V_{GS}$  rating is for low duty cycle pulse occurrence only. No continuous rating is implied.
  - Pulse  $I_d$  measured at 250  $\mu$ s, refer to Figure 11 SOA graph for more details.
  - Computed continuous current limited to Max Junction Temperature only, actual continuous current will be limited by thermal & electro-mechanical application board design.

TYPICAL CHARACTERISTICS

$T_J = 25^\circ\text{C}$  Unless Otherwise Noted

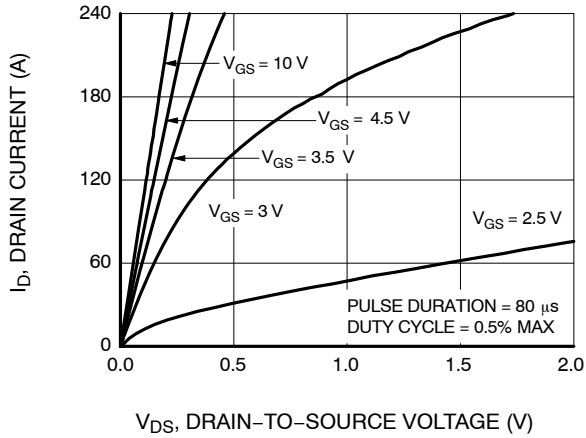

Figure 1. On-Region Characteristics

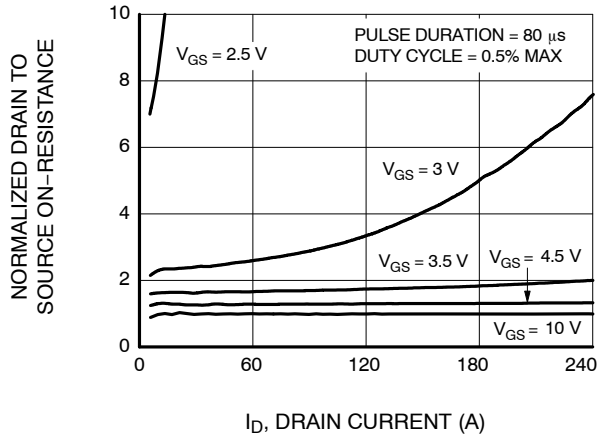

Figure 2. Normalized On-Resistance vs Drain Current and Gate Voltage

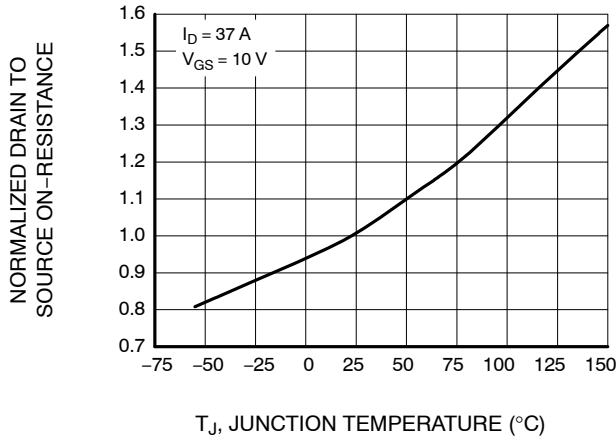

Figure 3. Normalized On Resistance vs Junction Temperature

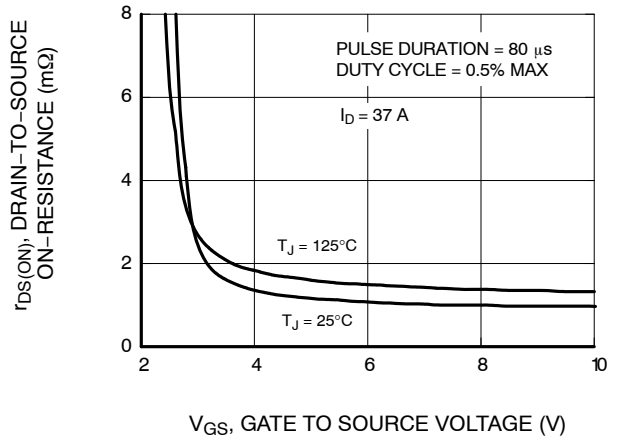

Figure 4. On-Resistance vs Gate to Source Voltage

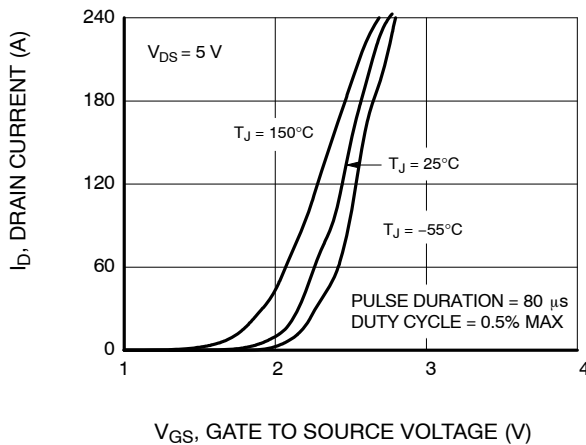

Figure 5. Transfer Characteristics

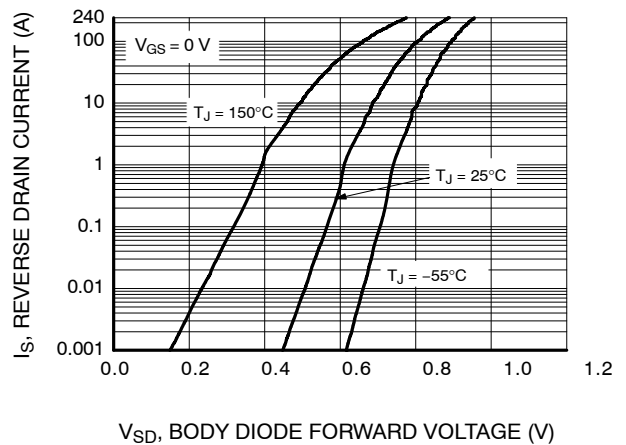

Figure 6. Source to Drain Diode Forward Voltage vs Source Current

# FDMC8010DC

## TYPICAL CHARACTERISTICS (continued)

$T_J = 25^\circ\text{C}$  Unless Otherwise Noted

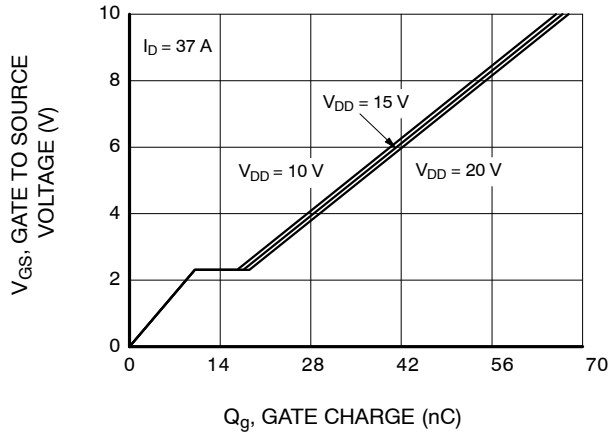

Figure 7. Gate Charge Characteristics

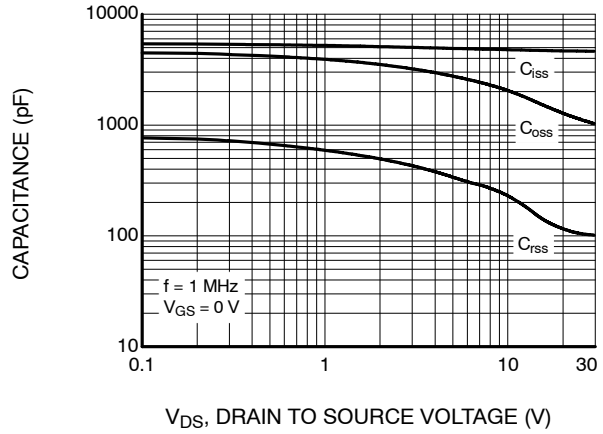

Figure 8. Capacitance vs Drain to Source Voltage

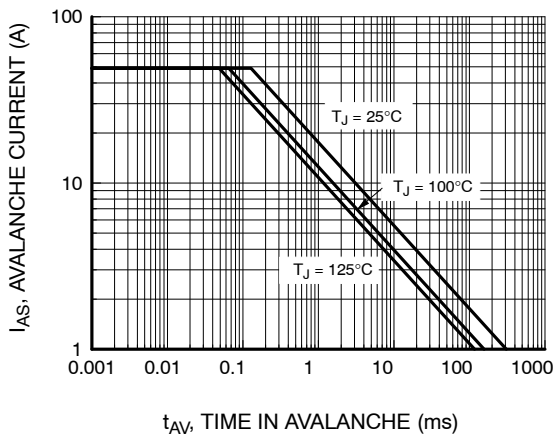

Figure 9. Unclamped Inductive Switching Capability

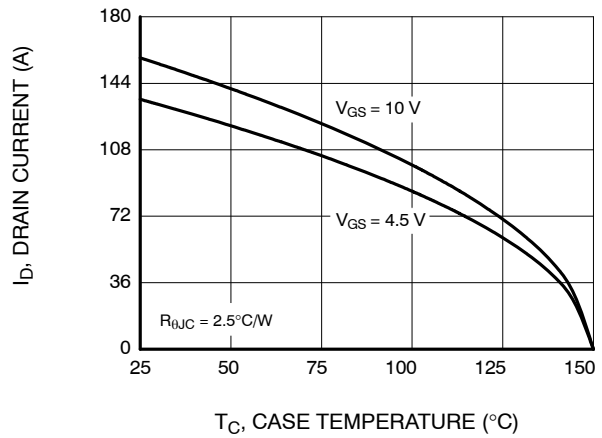

Figure 10. Maximum Continuous Drain Current vs Case Temperature

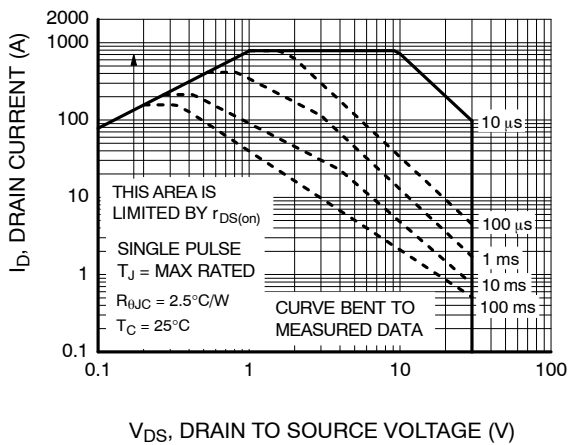

Figure 11. Forward Bias Safe Operating Area

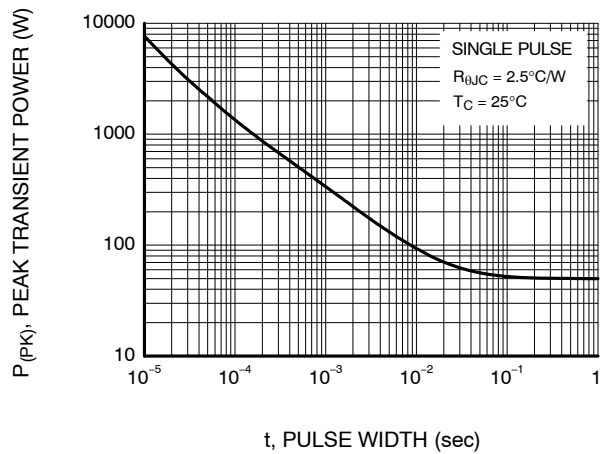

Figure 12. Single Pulse Maximum Power Dissipation

# FDMC8010DC

## TYPICAL CHARACTERISTICS (continued)

$T_J = 25^\circ\text{C}$  Unless Otherwise Noted

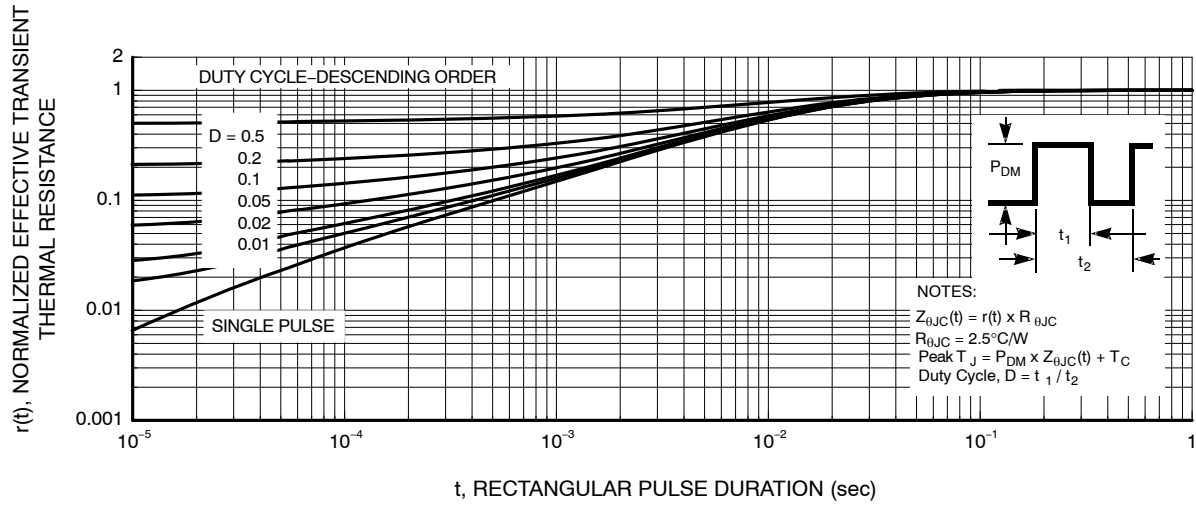
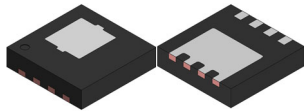

Figure 13. Junction to Case Transient Thermal Response Curve

POWERTRENCH and DUAL COOL are registered trademarks of Semiconductor Components Industries, LLC (SCILLC) or its subsidiaries in the United States and/or other countries.

# MECHANICAL CASE OUTLINE PACKAGE DIMENSIONS



**PQFN8 3.3X3.3, 0.65P**  
CASE 483AY  
ISSUE A

DATE 08 SEP 2021

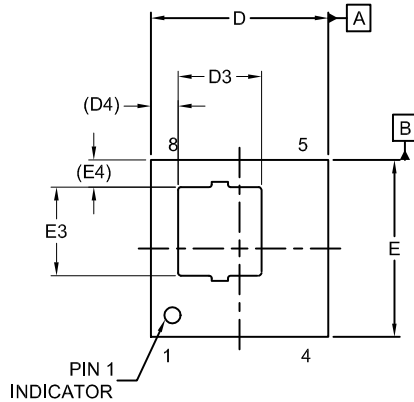

TOP VIEW

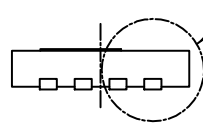

FRONT VIEW

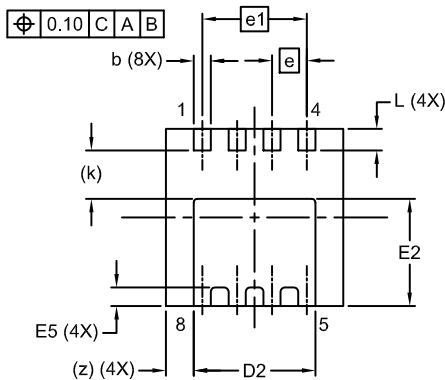

BOTTOM VIEW

NOTES:

1. DIMENSIONING AND TOLERANCING PER ASME Y14.5M, 2009.
2. CONTROLLING DIMENSION: MILLIMETERS
3. COPLANARITY APPLIES TO THE EXPOSED PADS AS WELL AS THE TERMINALS.
4. DIMENSIONS D1 AND E1 DO NOT INCLUDE MOLD FLASH, PROTRUSIONS, OR GATE BURRS.
5. SEATING PLANE IS DEFINED BY THE TERMINALS. "A1" IS DEFINED AS THE DISTANCE FROM THE SEATING PLANE TO THE LOWEST POINT ON THE PACKAGE BODY.

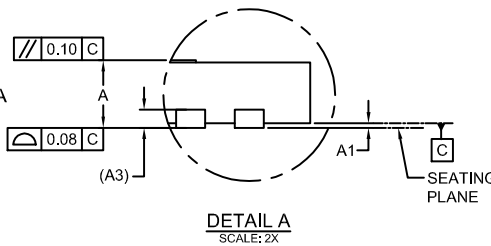

DETAIL A  
SCALE: 2X

DIM	MILLIMETERS		
	MIN.	NOM.	MAX.
A	0.70	0.75	0.80
A1	0.00	-	0.05
A3	0.20 REF		
b	0.27	0.32	0.37
D	3.20	3.30	3.40
D2	2.17	2.27	2.37
D3	1.45	1.55	1.65
D4	0.51 REF		
E	3.20	3.30	3.40
E2	1.85	1.95	2.05
E3	1.55	1.65	1.75
E4	0.51 REF		
E5	0.24	0.34	0.44
e	0.65 BSC		
e1	1.95 BSC		
k	0.90 REF		
L	0.30	0.40	0.50
z	0.52 REF		

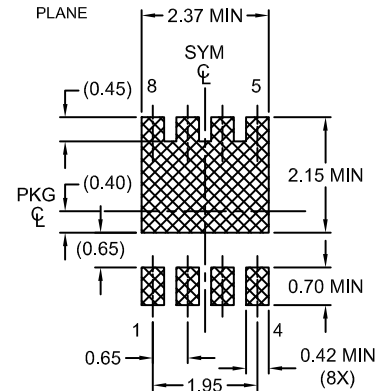

LAND PATTERN  
RECOMMENDATION

\*FOR ADDITIONAL INFORMATION ON OUR PB-FREE STRATEGY AND SOLDERING DETAILS, PLEASE DOWNLOAD THE ON SEMICONDUCTOR SOLDERING AND MOUNTING TECHNIQUES REFERENCE MANUAL, SOLDERRM/D.

<b>DOCUMENT NUMBER:</b>	<b>98AON13674G</b>	Electronic versions are uncontrolled except when accessed directly from the Document Repository. Printed versions are uncontrolled except when stamped "CONTROLLED COPY" in red.
<b>DESCRIPTION:</b>	<b>PQFN8 3.3X3.3, 0.65P</b>	<b>PAGE 1 OF 1</b>

onsemi and ONSEMI are trademarks of Semiconductor Components Industries, LLC dba onsemi or its subsidiaries in the United States and/or other countries. onsemi reserves the right to make changes without further notice to any products herein. onsemi makes no warranty, representation or guarantee regarding the suitability of its products for any particular purpose, nor does onsemi assume any liability arising out of the application or use of any product or circuit, and specifically disclaims any and all liability, including without limitation special, consequential or incidental damages. onsemi does not convey any license under its patent rights nor the rights of others.

**onsemi**, **Onsemi**, and other names, marks, and brands are registered and/or common law trademarks of Semiconductor Components Industries, LLC dba "**onsemi**" or its affiliates and/or subsidiaries in the United States and/or other countries. **onsemi** owns the rights to a number of patents, trademarks, copyrights, trade secrets, and other intellectual property. A listing of **onsemi**'s product/patent coverage may be accessed at [www.onsemi.com/site/pdf/Patent-Marking.pdf](http://www.onsemi.com/site/pdf/Patent-Marking.pdf). **onsemi** reserves the right to make changes at any time to any products or information herein, without notice. The information herein is provided "as-is" and **onsemi** makes no warranty, representation or guarantee regarding the accuracy of the information, product features, availability, functionality, or suitability of its products for any particular purpose, nor does **onsemi** assume any liability arising out of the application or use of any product or circuit, and specifically disclaims any and all liability, including without limitation special, consequential or incidental damages. Buyer is responsible for its products and applications using **onsemi** products, including compliance with all laws, regulations and safety requirements or standards, regardless of any support or applications information provided by **onsemi**. "Typical" parameters which may be provided in **onsemi** data sheets and/or specifications can and do vary in different applications and actual performance may vary over time. All operating parameters, including "Typicals" must be validated for each customer application by customer's technical experts. **onsemi** does not convey any license under any of its intellectual property rights nor the rights of others. **onsemi** products are not designed, intended, or authorized for use as a critical component in life support systems or any FDA Class 3 medical devices or medical devices with a same or similar classification in a foreign jurisdiction or any devices intended for implantation in the human body. Should Buyer purchase or use **onsemi** products for any such unintended or unauthorized application, Buyer shall indemnify and hold **onsemi** and its officers, employees, subsidiaries, affiliates, and distributors harmless against all claims, costs, damages, and expenses, and reasonable attorney fees arising out of, directly or indirectly, any claim of personal injury or death associated with such unintended or unauthorized use, even if such claim alleges that **onsemi** was negligent regarding the design or manufacture of the part. **onsemi** is an Equal Opportunity/Affirmative Action Employer. This literature is subject to all applicable copyright laws and is not for resale in any manner.

---

## ADDITIONAL INFORMATION

### TECHNICAL PUBLICATIONS:

Technical Library: [www.onsemi.com/design/resources/technical-documentation](http://www.onsemi.com/design/resources/technical-documentation)  
onsemi Website: [www.onsemi.com](http://www.onsemi.com)

### ONLINE SUPPORT: [www.onsemi.com/support](http://www.onsemi.com/support)

For additional information, please contact your local Sales Representative at [www.onsemi.com/support/sales](http://www.onsemi.com/support/sales)