

# Silicon Carbide (SiC) MOSFET – EliteSiC, 22 mohm, 1200 V, M3S, TO-247-3L NTHL022N120M3S

## Features

- Typ.  $R_{DS(on)} = 22\text{ m}\Omega @ V_{GS} = 18\text{ V}$
- Ultra Low Gate Charge ( $Q_{G(tot)} = 137\text{ nC}$ )
- Low Effective Output Capacitance ( $C_{oss} = 146\text{ pF}$ )
- 100% Avalanche Tested
- This Device is Halide Free and RoHS Compliant with Exemption 7a, Pb-Free 2LI (on second level interconnection)

## Typical Applications

- Solar Inverters
- Electric Vehicle Charging Stations
- UPS (Uninterruptible Power Supplies)
- Energy Storage Systems
- SMPS (Switch Mode Power Supplies)

## MAXIMUM RATINGS ( $T_J = 25^\circ\text{C}$ unless otherwise noted)

Parameter	Symbol	Value	Unit
Drain-to-Source Voltage	$V_{DSS}$	1200	V
Gate-to-Source Voltage	$V_{GS}$	-10/+22	V
Recommended Operation Values of Gate-to-Source Voltage	$T_C < 175^\circ\text{C}$ $V_{GSop}$	-3/+18	V
Continuous Drain Current (Notes 1, 3)	Steady State $T_C = 25^\circ\text{C}$	$I_D$	89 A
		$P_D$	348 W
Power Dissipation (Note 1)	Steady State $T_C = 100^\circ\text{C}$	$I_D$	62 A
		$P_D$	174 W
Continuous Drain Current (Notes 1, 3)	Steady State $T_C = 25^\circ\text{C}$	$I_{DM}$	275 A
Pulsed Drain Current (Note 2)	$T_C = 25^\circ\text{C}$	$I_{DM}$	275 A
Operating Junction and Storage Temperature Range	$T_J, T_{stg}$	-55 to +175	$^\circ\text{C}$
Source Current (Body Diode) $T_C = 25^\circ\text{C}$ $V_{GS} = -3\text{ V}$ (Note 1)	$I_S$	72	A
Single Pulse Drain-to-Source Avalanche Energy ( $I_{L(pk)} = 23.1\text{ A}$ , $L = 1\text{ mH}$ ) (Note 4)	$E_{AS}$	267	mJ
Maximum Lead Temperature for Soldering (1/25" from case for 10 s)	$T_L$	270	$^\circ\text{C}$

Stresses exceeding those listed in the Maximum Ratings table may damage the device. If any of these limits are exceeded, device functionality should not be assumed, damage may occur and reliability may be affected.

1. The entire application environment impacts the thermal resistance values shown, they are not constants and are only valid for the particular conditions noted.
2. Repetitive rating, limited by max junction temperature.
3. The maximum current rating is based on typical  $R_{DS(on)}$  performance.
4.  $E_{AS}$  of 267 mJ is based on starting  $T_J = 25^\circ\text{C}$ ;  $L = 1\text{ mH}$ ,  $I_{AS} = 23.1\text{ A}$ ,  $V_{DD} = 100\text{ V}$ ,  $V_{GS} = 18\text{ V}$ .

$V_{(BR)DSS}$	$R_{DS(ON)}\text{ MAX}$	$I_D\text{ MAX}$
1200 V	30 m $\Omega$ @ 18 V	89 A

## N-CHANNEL MOSFET

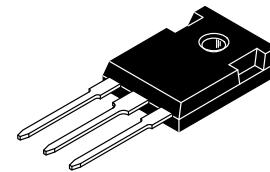
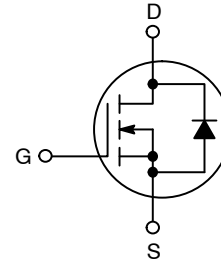

TO-247-3L  
CASE 340CX

## MARKING DIAGRAM



HL022N120M3S = Specific Device Code  
 A = Assembly Location  
 Y = Year  
 WW = Work Week  
 ZZ = Lot Traceability

## ORDERING INFORMATION

Device	Package	Shipping
NTHL022N120M3S	TO-247-3L	30 Units / Tube

# NTHL022N120M3S

## THERMAL CHARACTERISTICS

Parameter	Symbol	Max	Unit
Junction-to-Case – Steady State (Note 1)	$R_{\theta JC}$	0.43	°C/W
Junction-to-Ambient – Steady State (Note 1)	$R_{\theta JA}$	40	

## ELECTRICAL CHARACTERISTICS ( $T_J = 25^\circ\text{C}$ unless otherwise specified)

Parameter	Symbol	Test Condition	Min	Typ	Max	Unit
-----------	--------	----------------	-----	-----	-----	------

### OFF-STATE CHARACTERISTICS

Drain-to-Source Breakdown Voltage	$V_{(BR)DSS}$	$V_{GS} = 0\text{ V}, I_D = 1\text{ mA}$	1200	-	-	V
Drain-to-Source Breakdown Voltage Temperature Coefficient	$V_{(BR)DSS}/T_J$	$I_D = 1\text{ mA}$ , referenced to $25^\circ\text{C}$ (Note 6)	-	0.3	-	V/°C
Zero Gate Voltage Drain Current	$I_{DSS}$	$V_{GS} = 0\text{ V}, V_{DS} = 1200\text{ V}, T_J = 25^\circ\text{C}$	-	-	100	$\mu\text{A}$
Gate-to-Source Leakage Current	$I_{GSS}$	$V_{GS} = +22/-10\text{ V}, V_{DS} = 0\text{ V}$	-	-	$\pm 1$	$\mu\text{A}$

### ON-STATE CHARACTERISTICS

Gate Threshold Voltage	$V_{GS(TH)}$	$V_{GS} = V_{DS}, I_D = 20\text{ mA}$	2.04	2.72	4.4	V
Recommended Gate Voltage	$V_{GOP}$		-3	-	+18	V
Drain-to-Source On Resistance	$R_{DS(on)}$	$V_{GS} = 18\text{ V}, I_D = 40\text{ A}, T_J = 25^\circ\text{C}$	-	22	30	m $\Omega$
		$V_{GS} = 18\text{ V}, I_D = 40\text{ A}, T_J = 175^\circ\text{C}$ (Note 6)	-	44	-	
Forward Transconductance	$g_{FS}$	$V_{DS} = 10\text{ V}, I_D = 40\text{ A}$ (Note 6)	-	34	-	S

### CHARGES, CAPACITANCES & GATE RESISTANCE

Input Capacitance	$C_{ISS}$	$V_{GS} = 0\text{ V}, f = 1\text{ MHz}, V_{DS} = 800\text{ V}$	-	3175	-	pF
Output Capacitance	$C_{OSS}$		-	146	-	
Reverse Transfer Capacitance	$C_{RSS}$		-	14	-	
Total Gate Charge	$Q_G(TOT)$	$V_{GS} = -3/18\text{ V}, V_{DS} = 800\text{ V}, I_D = 40\text{ A}$	-	137	-	nC
Threshold Gate Charge	$Q_G(TH)$		-	9.2	-	
Gate-to-Source Charge	$Q_{GS}$		-	15	-	
Gate-to-Drain Charge	$Q_{GD}$		-	34	-	
Gate-Resistance	$R_G$	$f = 1\text{ MHz}$	-	1.5	-	$\Omega$

### SWITCHING CHARACTERISTICS

Turn-On Delay Time	$t_{d(ON)}$	$V_{GS} = -3/18\text{ V}, V_{DS} = 800\text{ V}, I_D = 40\text{ A}, R_G = 4.5\text{ }\Omega$ Inductive Load (Notes 5, 6)	-	19	-	ns
Rise Time	$t_r$		-	50	-	
Turn-Off Delay Time	$t_{d(OFF)}$		-	44	-	
Fall Time	$t_f$		-	14	-	
Turn-On Switching Loss	$E_{ON}$		-	1212	-	$\mu\text{J}$
Turn-Off Switching Loss	$E_{OFF}$		-	307	-	
Total Switching Loss	$E_{tot}$		-	1519	-	

### SOURCE-DRAIN DIODE CHARACTERISTICS

Continuous Source-Drain Diode Forward Current (Note 1)	$I_{SD}$	$V_{GS} = -3\text{ V}, T_C = 25^\circ\text{C}$ (Note 6)	-	-	72	A
Pulsed Source-Drain Diode Forward Current (Note 2)	$I_{SDM}$		-	-	275	
Forward Diode Voltage	$V_{SD}$	$V_{GS} = -3\text{ V}, I_{SD} = 40\text{ A}, T_J = 25^\circ\text{C}$	-	4.5	-	V

# NTHL022N120M3S

## ELECTRICAL CHARACTERISTICS ( $T_J = 25^\circ\text{C}$ unless otherwise specified) (continued)

Parameter	Symbol	Test Condition	Min	Typ	Max	Unit
<b>SOURCE-DRAIN DIODE CHARACTERISTICS</b>						
Reverse Recovery Time	$t_{RR}$	$V_{GS} = -3/18\text{ V}, I_{SD} = 40\text{ A},$ $di_S/dt = 1000\text{ A}/\mu\text{s}, V_{DS} = 800\text{ V}$ (Note 6)	-	24	-	ns
Reverse Recovery Charge	$Q_{RR}$		-	150	-	nC
Reverse Recovery Energy	$E_{REC}$		-	14	-	$\mu\text{J}$
Peak Reverse Recovery Current	$I_{RRM}$		-	12	-	A
Charge time	$t_A$		-	14	-	ns
Discharge time	$t_B$		-	11	-	ns

Product parametric performance is indicated in the Electrical Characteristics for the listed test conditions, unless otherwise noted. Product performance may not be indicated by the Electrical Characteristics if operated under different conditions.

5.  $E_{ON}/E_{OFF}$  result is with body diode.

6. Defined by design, not subject to production test.

TYPICAL CHARACTERISTICS

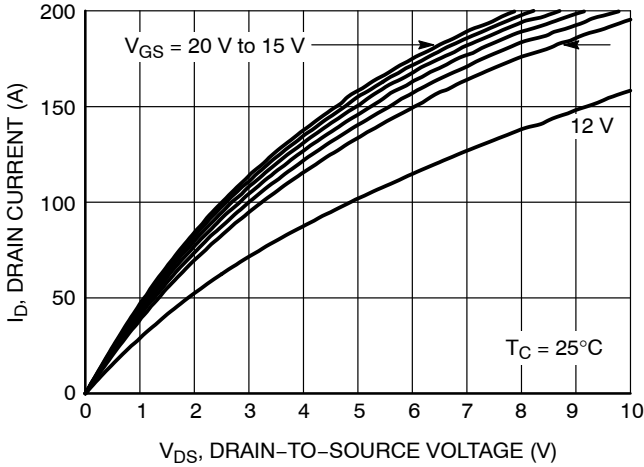

Figure 1. On-Region Characteristics

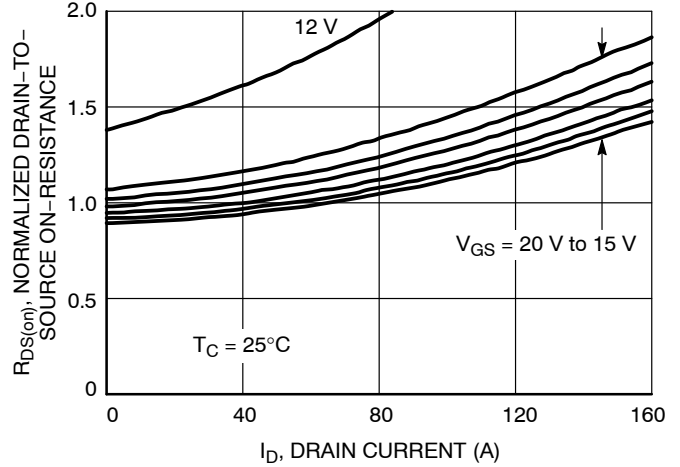

Figure 2. Normalized On-Resistance vs. Drain Current and Gate Voltage

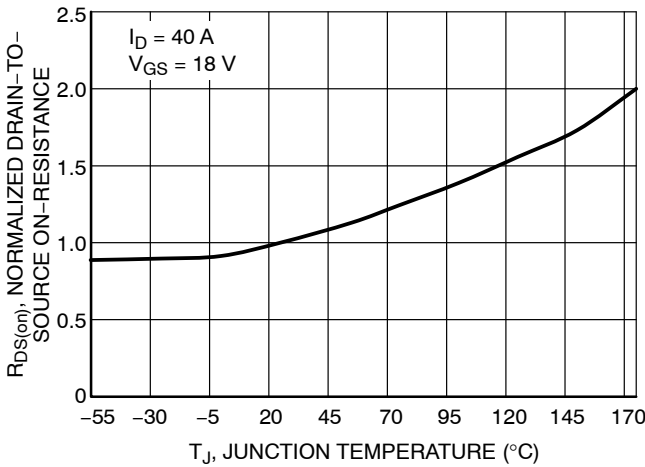

Figure 3. On-Resistance Variation with Temperature

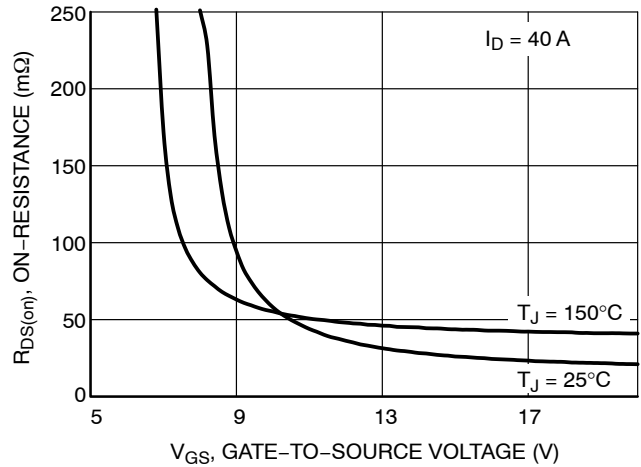

Figure 4. On-Resistance vs. Gate-to-Source Voltage

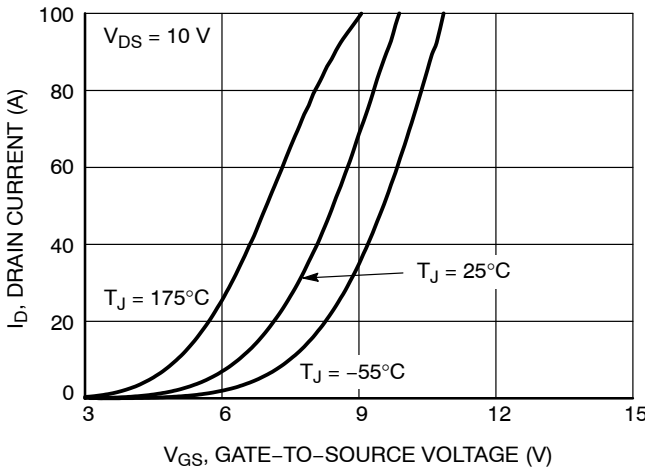

Figure 5. Transfer Characteristics

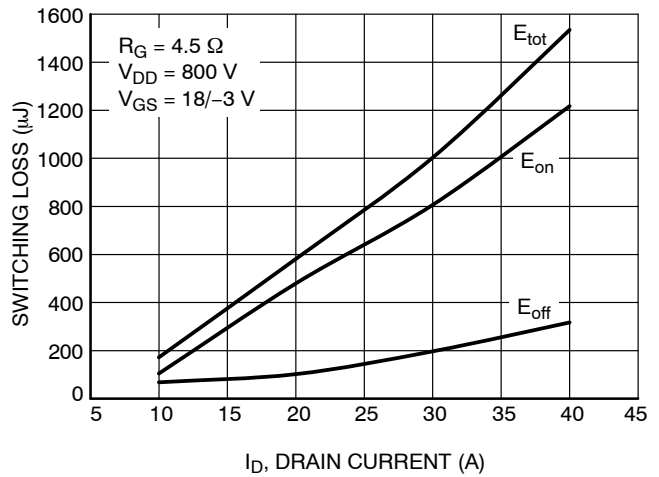

Figure 6. Switching Loss vs. Drain Current

TYPICAL CHARACTERISTICS

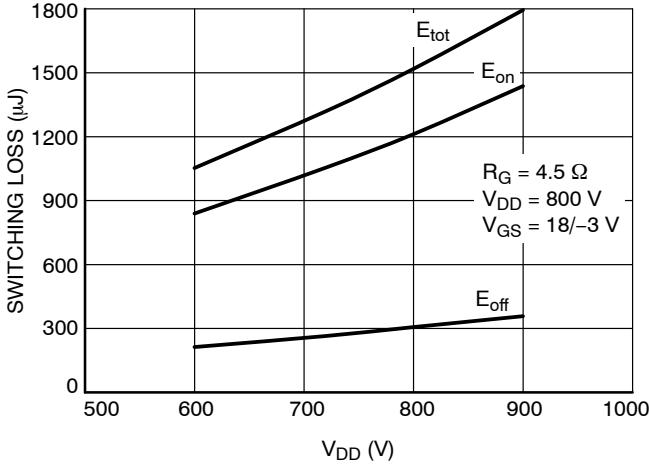

Figure 7. Switching Loss vs. Drain Voltage

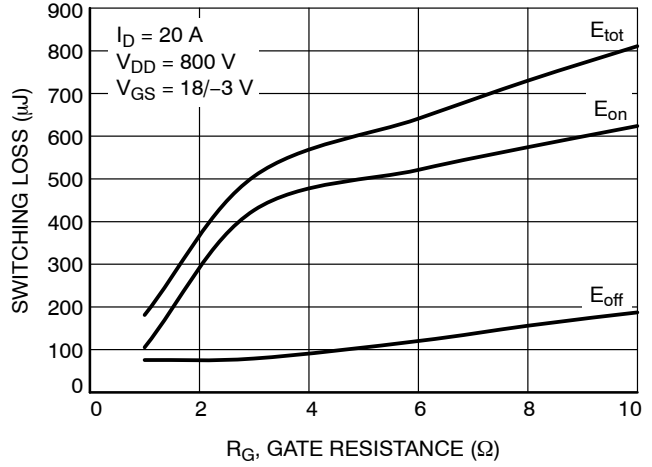

Figure 8. Switching Loss vs. Gate Resistance

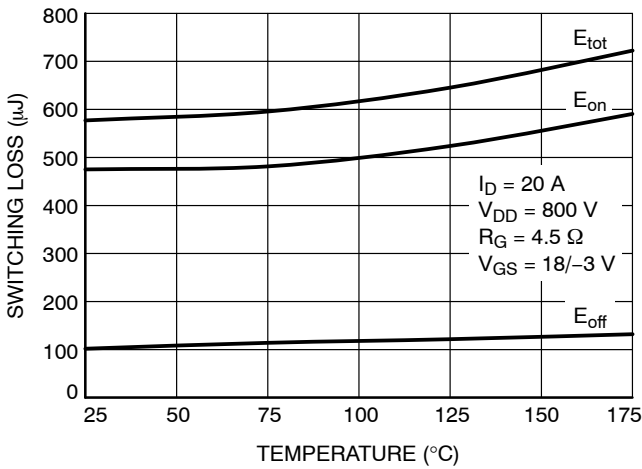

Figure 9. Switching Loss vs. Temperature

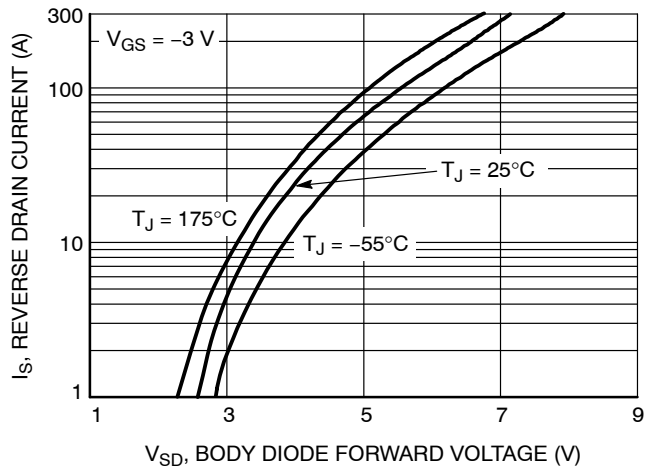

Figure 10. Diode Forward Voltage vs. Current

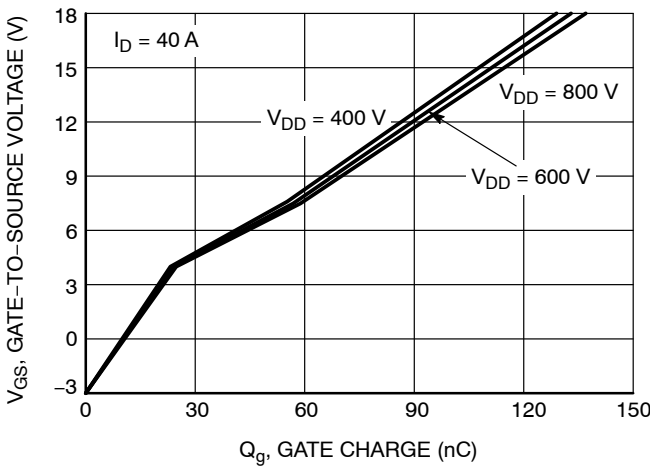

Figure 11. Gate-to-Source Voltage vs. Total Charge

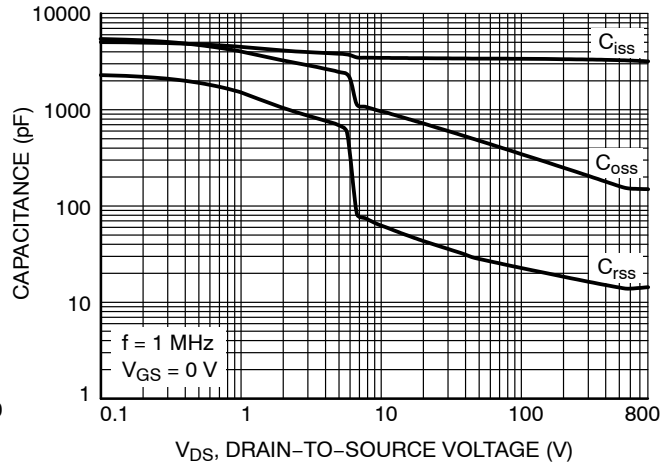

Figure 12. Capacitance vs. Drain-to-Source Voltage

TYPICAL CHARACTERISTICS

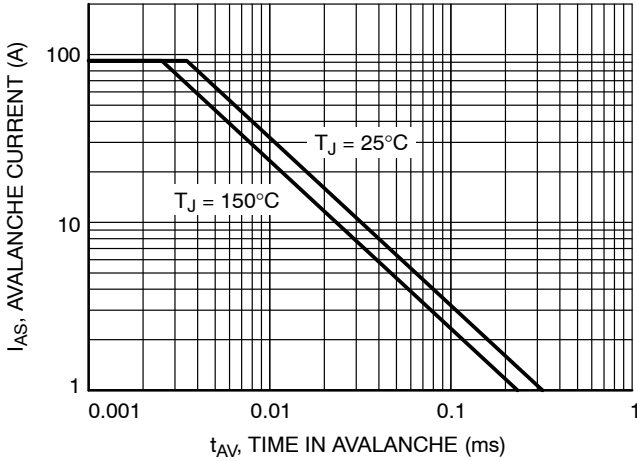

Figure 13. Unclamped Inductive Switching Capability

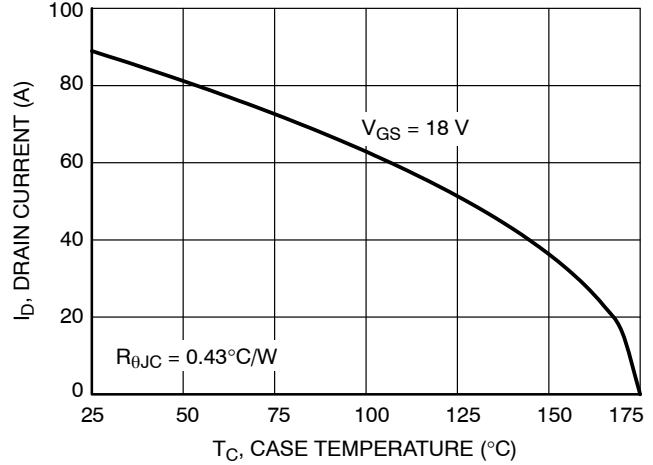

Figure 14. Maximum Continuous Drain Current vs. Case Temperature

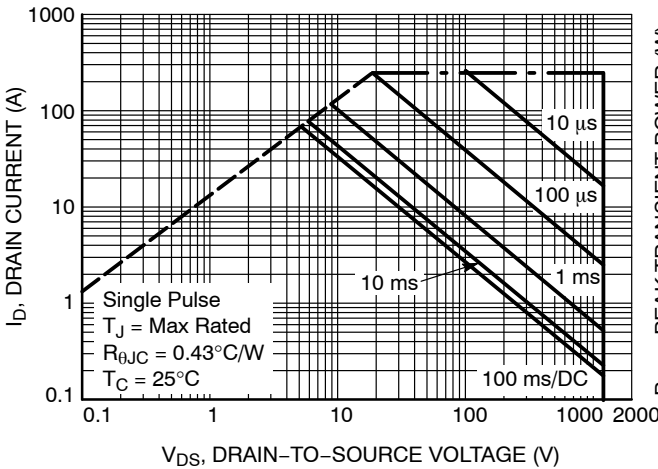

Figure 15. Safe Operating Area

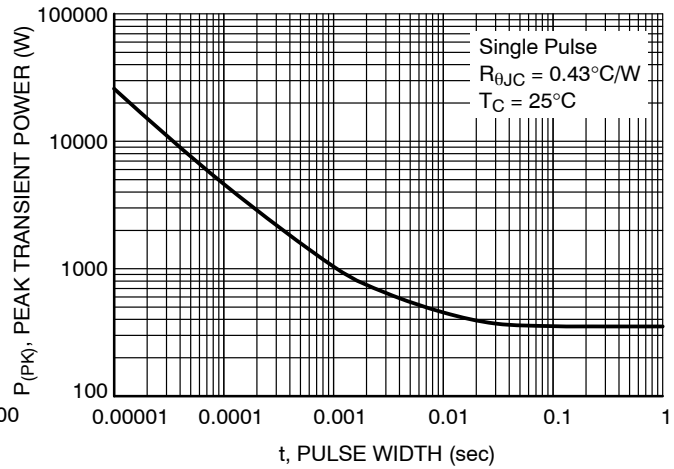

Figure 16. Single Pulse Maximum Power Dissipation

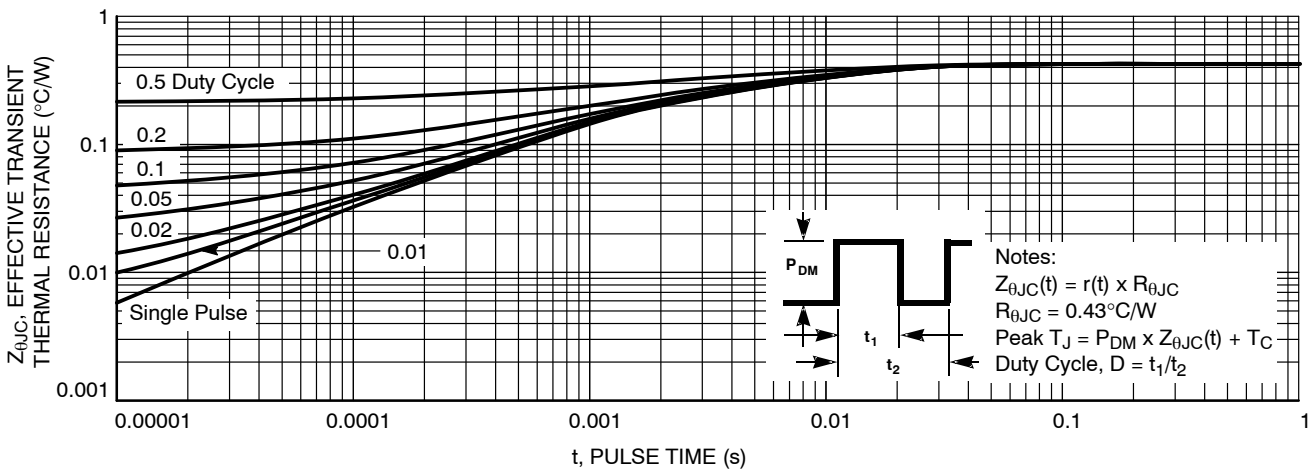

Figure 17. Junction-to-Case Transient Thermal Response

# MECHANICAL CASE OUTLINE

## PACKAGE DIMENSIONS

ON Semiconductor®



TO-247-3LD  
CASE 340CX  
ISSUE A

DATE 06 JUL 2020

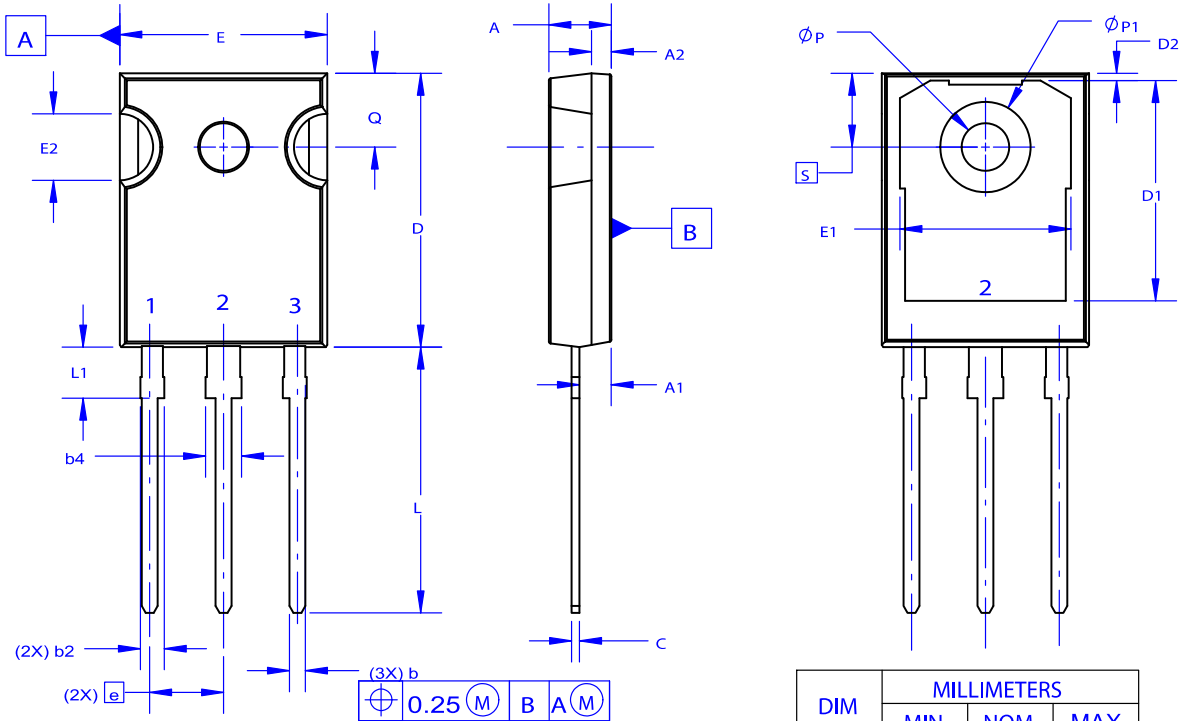
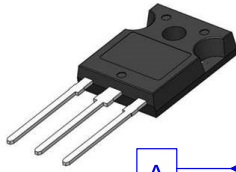

NOTES: UNLESS OTHERWISE SPECIFIED.

- A. DIMENSIONS ARE EXCLUSIVE OF BURRS, MOLD FLASH, AND TIE BAR EXTRUSIONS.
- B. ALL DIMENSIONS ARE IN MILLIMETERS.
- C. DRAWING CONFORMS TO ASME Y14.5 - 2009.
- D. DIMENSION A1 TO BE MEASURED IN THE REGION DEFINED BY L1.
- E. LEAD FINISH IS UNCONTROLLED IN THE REGION DEFINED BY L1.

DIM	MILLIMETERS		
	MIN	NOM	MAX
A	4.58	4.70	4.82
A1	2.20	2.40	2.60
A2	1.40	1.50	1.60
D	20.32	20.57	20.82
E	15.37	15.62	15.87
E2	4.96	5.08	5.20
e	~	5.56	~
L	19.75	20.00	20.25
L1	3.69	3.81	3.93
ØP	3.51	3.58	3.65
Q	5.34	5.46	5.58
S	5.34	5.46	5.58
b	1.17	1.26	1.35
b2	1.53	1.65	1.77
b4	2.42	2.54	2.66
c	0.51	0.61	0.71
D1	13.08	~	~
D2	0.51	0.93	1.35
E1	12.81	~	~
ØP1	6.60	6.80	7.00

### GENERIC MARKING DIAGRAM\*



- XXXXX = Specific Device Code
- A = Assembly Location
- Y = Year
- WW = Work Week
- G = Pb-Free Package

\*This information is generic. Please refer to device data sheet for actual part marking. Pb-Free indicator, "G" or microdot "▪", may or may not be present. Some products may not follow the Generic Marking.

<b>DOCUMENT NUMBER:</b>	<b>98AON93302G</b>	Electronic versions are uncontrolled except when accessed directly from the Document Repository. Printed versions are uncontrolled except when stamped "CONTROLLED COPY" in red.
<b>DESCRIPTION:</b>	<b>TO-247-3LD</b>	<b>PAGE 1 OF 1</b>

ON Semiconductor and are trademarks of Semiconductor Components Industries, LLC dba ON Semiconductor or its subsidiaries in the United States and/or other countries. ON Semiconductor reserves the right to make changes without further notice to any products herein. ON Semiconductor makes no warranty, representation or guarantee regarding the suitability of its products for any particular purpose, nor does ON Semiconductor assume any liability arising out of the application or use of any product or circuit, and specifically disclaims any and all liability, including without limitation special, consequential or incidental damages. ON Semiconductor does not convey any license under its patent rights nor the rights of others.

**onsemi**, **Onsemi**, and other names, marks, and brands are registered and/or common law trademarks of Semiconductor Components Industries, LLC dba "**onsemi**" or its affiliates and/or subsidiaries in the United States and/or other countries. **onsemi** owns the rights to a number of patents, trademarks, copyrights, trade secrets, and other intellectual property. A listing of **onsemi**'s product/patent coverage may be accessed at [www.onsemi.com/site/pdf/Patent-Marking.pdf](http://www.onsemi.com/site/pdf/Patent-Marking.pdf). **onsemi** reserves the right to make changes at any time to any products or information herein, without notice. The information herein is provided "as-is" and **onsemi** makes no warranty, representation or guarantee regarding the accuracy of the information, product features, availability, functionality, or suitability of its products for any particular purpose, nor does **onsemi** assume any liability arising out of the application or use of any product or circuit, and specifically disclaims any and all liability, including without limitation special, consequential or incidental damages. Buyer is responsible for its products and applications using **onsemi** products, including compliance with all laws, regulations and safety requirements or standards, regardless of any support or applications information provided by **onsemi**. "Typical" parameters which may be provided in **onsemi** data sheets and/or specifications can and do vary in different applications and actual performance may vary over time. All operating parameters, including "Typicals" must be validated for each customer application by customer's technical experts. **onsemi** does not convey any license under any of its intellectual property rights nor the rights of others. **onsemi** products are not designed, intended, or authorized for use as a critical component in life support systems or any FDA Class 3 medical devices or medical devices with a same or similar classification in a foreign jurisdiction or any devices intended for implantation in the human body. Should Buyer purchase or use **onsemi** products for any such unintended or unauthorized application, Buyer shall indemnify and hold **onsemi** and its officers, employees, subsidiaries, affiliates, and distributors harmless against all claims, costs, damages, and expenses, and reasonable attorney fees arising out of, directly or indirectly, any claim of personal injury or death associated with such unintended or unauthorized use, even if such claim alleges that **onsemi** was negligent regarding the design or manufacture of the part. **onsemi** is an Equal Opportunity/Affirmative Action Employer. This literature is subject to all applicable copyright laws and is not for resale in any manner.

---

## ADDITIONAL INFORMATION

### TECHNICAL PUBLICATIONS:

Technical Library: [www.onsemi.com/design/resources/technical-documentation](http://www.onsemi.com/design/resources/technical-documentation)  
onsemi Website: [www.onsemi.com](http://www.onsemi.com)

### ONLINE SUPPORT: [www.onsemi.com/support](http://www.onsemi.com/support)

For additional information, please contact your local Sales Representative at [www.onsemi.com/support/sales](http://www.onsemi.com/support/sales)