

Mechanical Dimensions: Inches [mm]

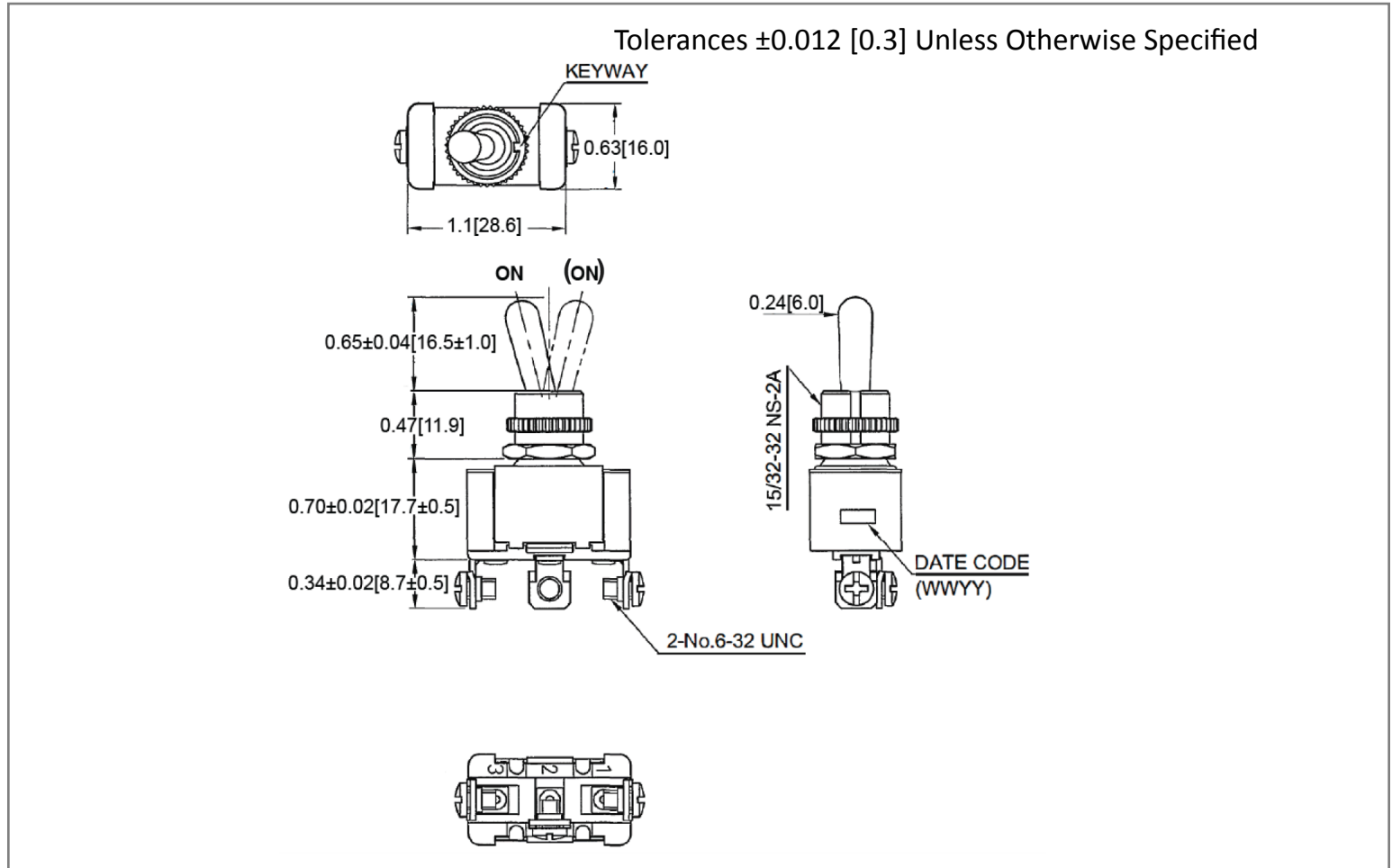

Mounting Hole

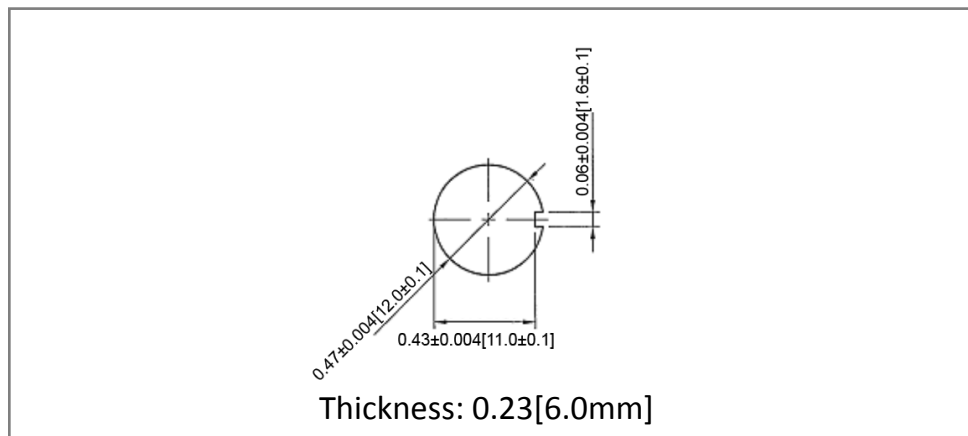

Circuit Diagram

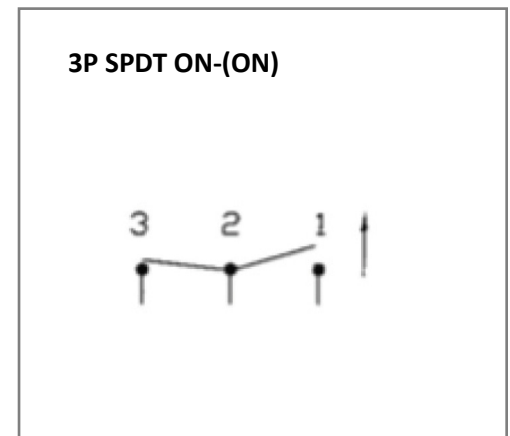

Electrical Specifications

Rating	21A 14V DC
Contact Resistance	50m ohm Max
Insulation Resistance	DC 500V 100M ohm Min
Dielectric Strength	AC 1500V 1 minute
Operation Temperature	-20°C ~ 85°C

Material Specifications

Operation Force	700gf±250gf
	1 hex nut assy
	1 knurl nut assy

Rev **Date of issue** **Revision Notes**

Designed **Approved**

B	02-26-2020	Initial Drawing	RC	OF
---	------------	-----------------	----	----