

Variant name: TE0741-03-410-2CF

# Top View

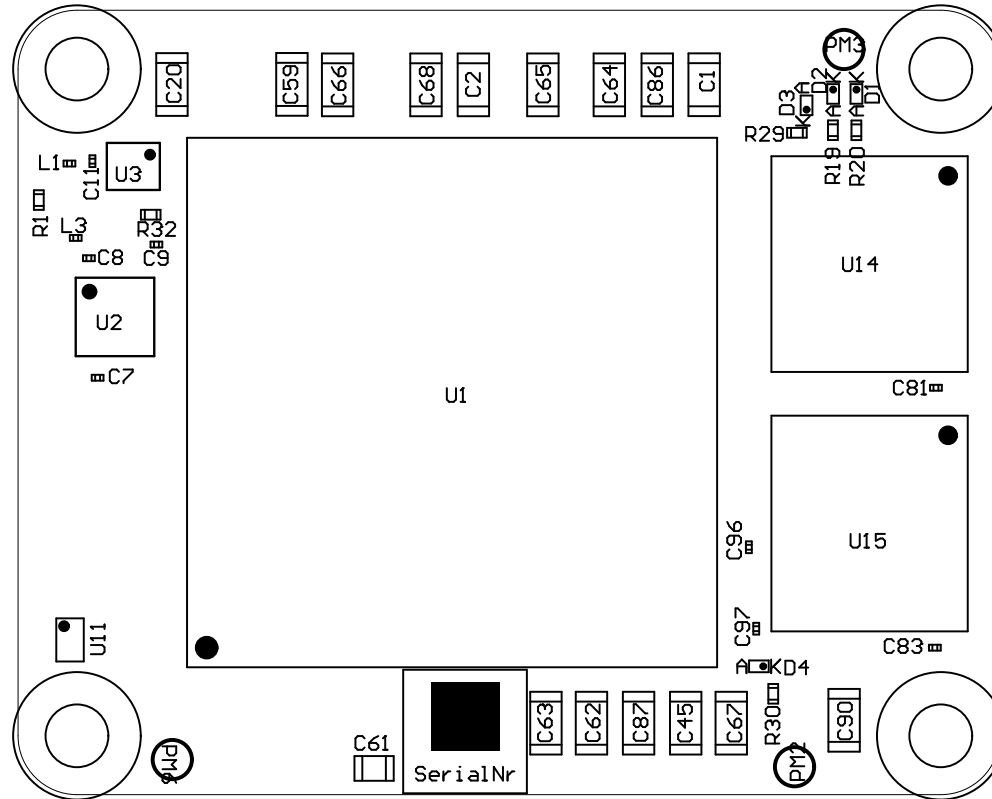

Variant name: TE0741-03-410-2CF

# Bottom View

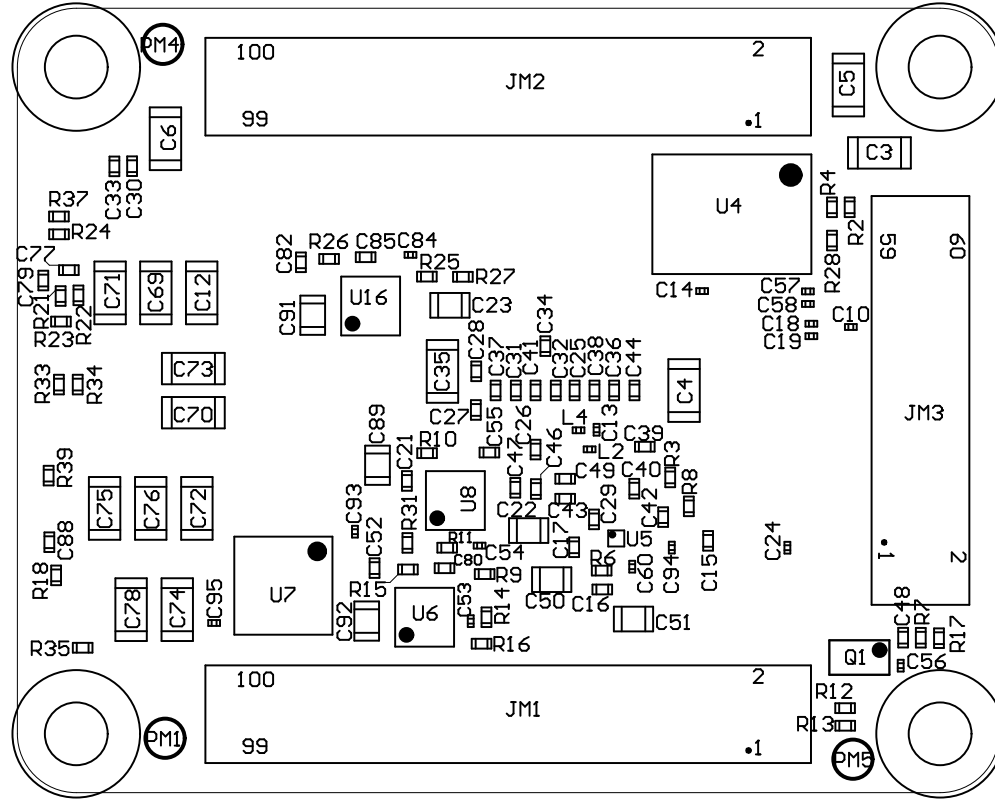

Top View

Top View

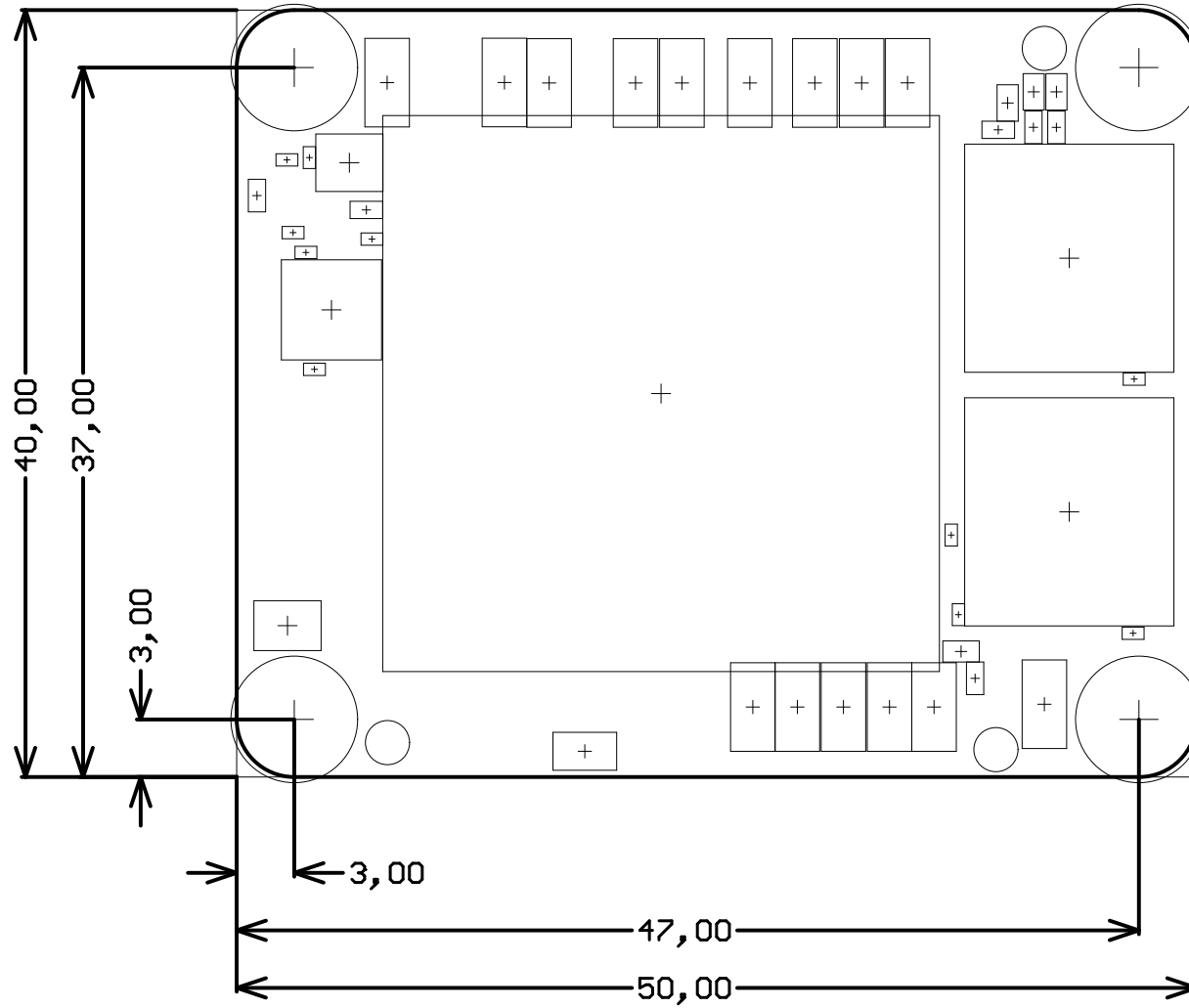

Mounting Holes

Top View

Top View

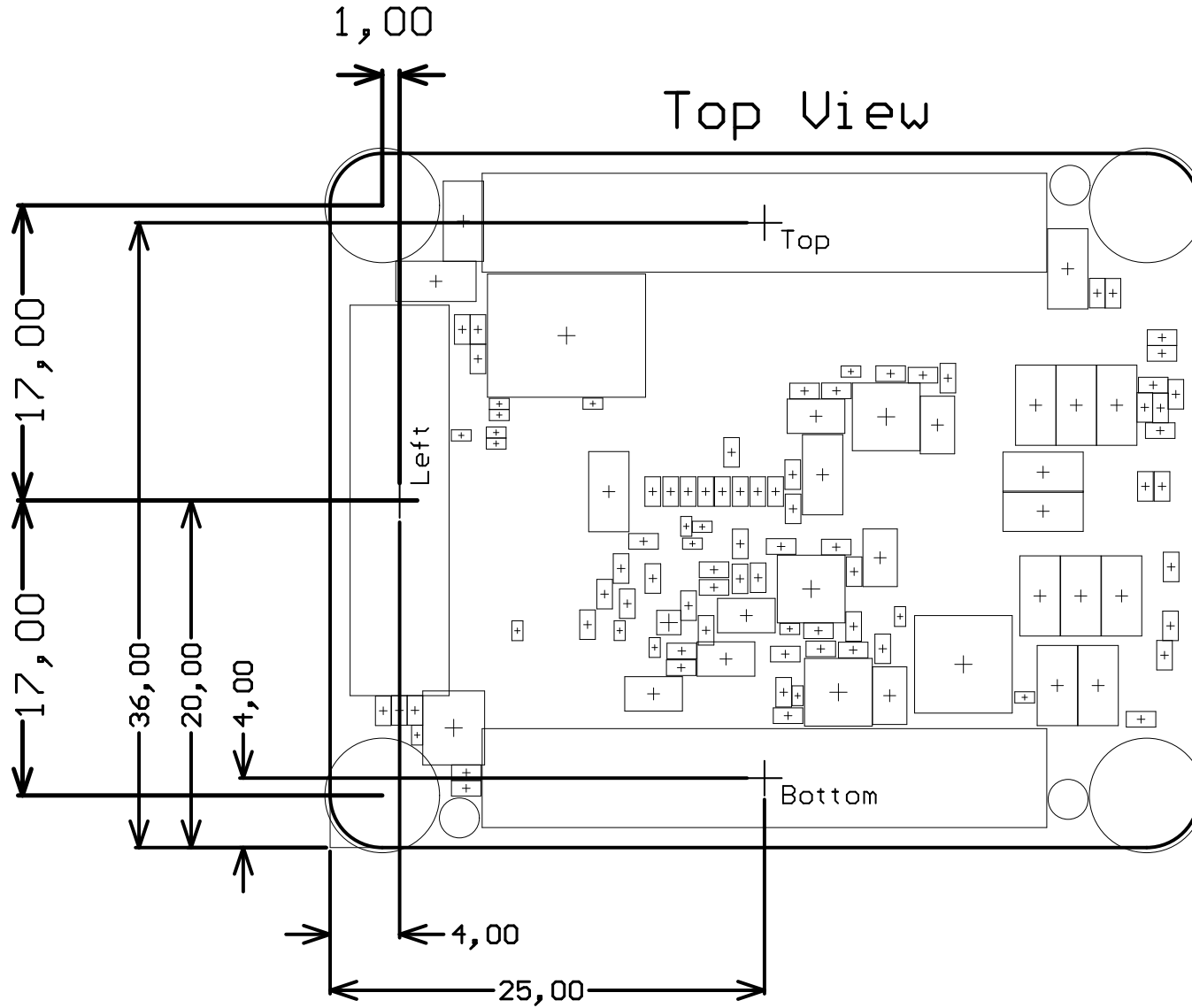

Samtec Connectors