

OSRAM LW A673

Datasheet

Not for new design

Published by ams-OSRAM AG

Tobelbader Strasse 30, 8141 Premstaetten, Austria

Phone +43 3136 500-0

ams-osram.com

© All rights reserved



SIDELED®

LW A673 binning FK0PN0



Applications

- Cluster, Button Backlighting
- Electronic Equipment
- Interior Illumination (e.g. Ambient Map)

Features

- Package: white SMT package, colored diffused resin
- Chip technology: InGaN
- Typ. Radiation: 120° (Lambertian emitter)
- Color: $C_x = 0.33$, $C_y = 0.33$ acc. to CIE 1931 (● white)
- Corrosion Robustness Class: 3B
- Qualifications: The product qualification test plan is based on the guidelines of AEC-Q101-REV-C, Stress Test Qualification for Automotive Grade Discrete Semiconductors.
- ESD: 2 kV acc. to ANSI/ESDA/JEDEC JS-001 (HBM, Class 2)

Ordering Information

Type	Luminous Intensity ¹⁾ $I_F = 10 \text{ mA}$ I_v	Ordering Code
LW A673-P1S1-FK0PN0-1	45 ... 224 mcd	Q65112A1369

Maximum Ratings

Parameter	Symbol		Values
Operating Temperature	T_{op}	min.	-40 °C
		max.	100 °C
Storage Temperature	T_{stg}	min.	-40 °C
		max.	100 °C
Junction Temperature	T_j	max.	110 °C
Forward Current $T_s = 25\text{ °C}$	I_F	max.	20 mA
Surge Current $t \leq 10\ \mu\text{s}$; $D = 0.005$; $T_s = 25\text{ °C}$	I_{FS}	max.	200 mA
Reverse voltage ²⁾ $T_s = 25\text{ °C}$	V_R	max.	5 V
ESD withstand voltage acc. to ANSI/ESDA/JEDEC JS-001 (HBM, Class 2)	V_{ESD}		2 kV

Characteristics

$I_F = 10 \text{ mA}$; $T_s = 25 \text{ °C}$

Parameter	Symbol		Values
Chromaticity Coordinate ³⁾	C_x	typ.	0.33
	C_y	typ.	0.33
Viewing angle at 50% I_V	2ϕ	typ.	120 °
Forward Voltage ⁴⁾ $I_F = 10 \text{ mA}$	V_F	min.	2.70 V
		typ.	3.10 V
		max.	3.40 V
Reverse current ²⁾ $V_R = 5 \text{ V}$	I_R	typ.	10 μA
		max.	0.01 μA
Real thermal resistance junction/ambient ⁵⁾⁶⁾	$R_{thJA \text{ real}}$	max.	430 K / W
Real thermal resistance junction/solderpoint ⁵⁾	$R_{thJS \text{ real}}$	max.	200 K / W

Brightness Groups

Group	Luminous Intensity ¹⁾ $I_F = 10 \text{ mA}$ min. I_v	Luminous Intensity ¹⁾ $I_F = 10 \text{ mA}$ max. I_v	Luminous Flux ⁷⁾ $I_F = 10 \text{ mA}$ typ. Φ_v
P1	45 mcd	56 mcd	152 mlm
P2	56 mcd	71 mcd	191 mlm
Q1	71 mcd	90 mcd	242 mlm
Q2	90 mcd	112 mcd	303 mlm
R1	112 mcd	140 mcd	378 mlm
R2	140 mcd	180 mcd	480 mlm
S1	180 mcd	224 mcd	606 mlm

Forward Voltage Groups

Group	Forward Voltage ⁴⁾ $I_F = 10 \text{ mA}$ min. V_F	Forward Voltage ⁴⁾ $I_F = 10 \text{ mA}$ max. V_F
Z4	2.70 V	2.90 V
46	2.90 V	3.20 V
A4	3.20 V	3.40 V

Chromaticity Coordinate Groups

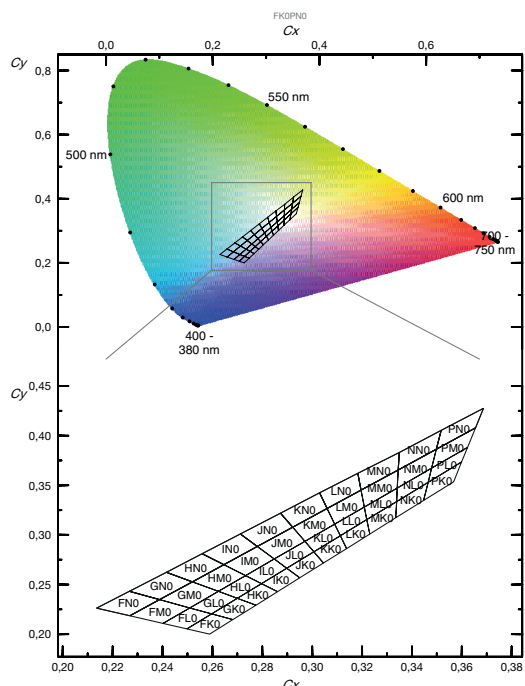

Chromaticity Coordinate Groups ³⁾

Group	Cx	Cy	Group	Cx	Cy	Group	Cx	Cy
FK0	0.2498	0.2053	GK0	0.2597	0.2204	HK0	0.2700	0.2361
	0.2597	0.2204		0.2700	0.2361		0.2797	0.2509
	0.2682	0.2146		0.2775	0.2292		0.2861	0.2427
	0.2589	0.2000		0.2682	0.2146		0.2775	0.2292
FL0	0.2402	0.2108	GL0	0.2509	0.2264	HL0	0.2624	0.2431
	0.2509	0.2264		0.2624	0.2431		0.2733	0.2590
	0.2597	0.2204		0.2700	0.2361		0.2797	0.2509
	0.2498	0.2053		0.2597	0.2204		0.2700	0.2361
FM0	0.2269	0.2185	GM0	0.2388	0.2348	HM0	0.2520	0.2527
	0.2388	0.2348		0.2520	0.2527		0.2646	0.2700
	0.2509	0.2264		0.2624	0.2431		0.2733	0.2590
	0.2402	0.2108		0.2509	0.2264		0.2624	0.2431
FN0	0.2136	0.2262	GN0	0.2267	0.2432	HN0	0.2416	0.2623
	0.2267	0.2432		0.2416	0.2623		0.2559	0.2810
	0.2388	0.2348		0.2520	0.2527		0.2646	0.2700
	0.2269	0.2185		0.2388	0.2348		0.2520	0.2527

Not for new design

Group	Cx	Cy	Group	Cx	Cy	Group	Cx	Cy
IK0	0.2797	0.2509	KK0	0.3007	0.2830	MK0	0.3219	0.3154
	0.2898	0.2664		0.3113	0.2992		0.3339	0.3336
	0.2950	0.2568		0.3138	0.2862		0.3335	0.3172
	0.2861	0.2427		0.3045	0.2717		0.3231	0.3008
ILO	0.2733	0.2590	KLO	0.2971	0.2935	MLO	0.3209	0.3281
	0.2848	0.2757		0.3090	0.3108		0.3341	0.3472
	0.2898	0.2664		0.3113	0.2992		0.3339	0.3336
	0.2797	0.2509		0.3007	0.2830		0.3219	0.3154
IMO	0.2646	0.2700	KMO	0.2922	0.3077	MM0	0.3196	0.3451
	0.2780	0.2883		0.3060	0.3266		0.3345	0.3654
	0.2848	0.2757		0.3090	0.3108		0.3341	0.3472
	0.2733	0.2590		0.2971	0.2935		0.3209	0.3281
INO	0.2559	0.2810	KNO	0.2873	0.3219	MNO	0.3183	0.3621
	0.2712	0.3009		0.3030	0.3424		0.3349	0.3830
	0.2780	0.2883		0.3060	0.3266		0.3345	0.3654
	0.2646	0.2700		0.2922	0.3077		0.3196	0.3451
JK0	0.2898	0.2664	LKO	0.3113	0.2992	NKO	0.3339	0.3336
	0.3007	0.2830		0.3219	0.3154		0.3465	0.3530
	0.3045	0.2717		0.3231	0.3008		0.3447	0.3347
	0.2950	0.2568		0.3138	0.2862		0.3335	0.3172
JLO	0.2848	0.2757	LLO	0.3090	0.3108	NLO	0.3341	0.3472
	0.2971	0.2935		0.3209	0.3281		0.3479	0.3673
	0.3007	0.2830		0.3219	0.3154		0.3465	0.3530
	0.2898	0.2664		0.3113	0.2992		0.3339	0.3336
JMO	0.2780	0.2883	LMO	0.3060	0.3266	NMO	0.3345	0.3654
	0.2922	0.3077		0.3196	0.3451		0.3498	0.3863
	0.2971	0.2935		0.3209	0.3281		0.3479	0.3673
	0.2848	0.2757		0.3090	0.3108		0.3341	0.3472
JNO	0.2712	0.3009	LNO	0.3030	0.3424	NNO	0.3349	0.3830
	0.2873	0.3219		0.3183	0.3621		0.3517	0.4053
	0.2922	0.3077		0.3196	0.3451		0.3498	0.3863
	0.2780	0.2883		0.3060	0.3266		0.3345	0.3654

Not for new design

Group	Cx	Cy	Group	Cx	Cy
PK0	0.3465	0.3530	PM0	0.3498	0.3863
	0.3599	0.3735		0.3655	0.4079
	0.3567	0.3535		0.3623	0.3882
	0.3447	0.3347		0.3479	0.3673
PL0	0.3479	0.3673	PN0	0.3517	0.4053
	0.3623	0.3882		0.3687	0.4276
	0.3599	0.3735		0.3655	0.4079
	0.3465	0.3530		0.3498	0.3863

Group Name on Label

Example: P1-FK0-46

Brightness	Color Chromaticity	Forward Voltage
P1	FK0	46

Relative Spectral Emission ⁷⁾

$\Phi_{rel} = f(\lambda); I_F = 10 \text{ mA}; T_S = 25 \text{ }^\circ\text{C}$

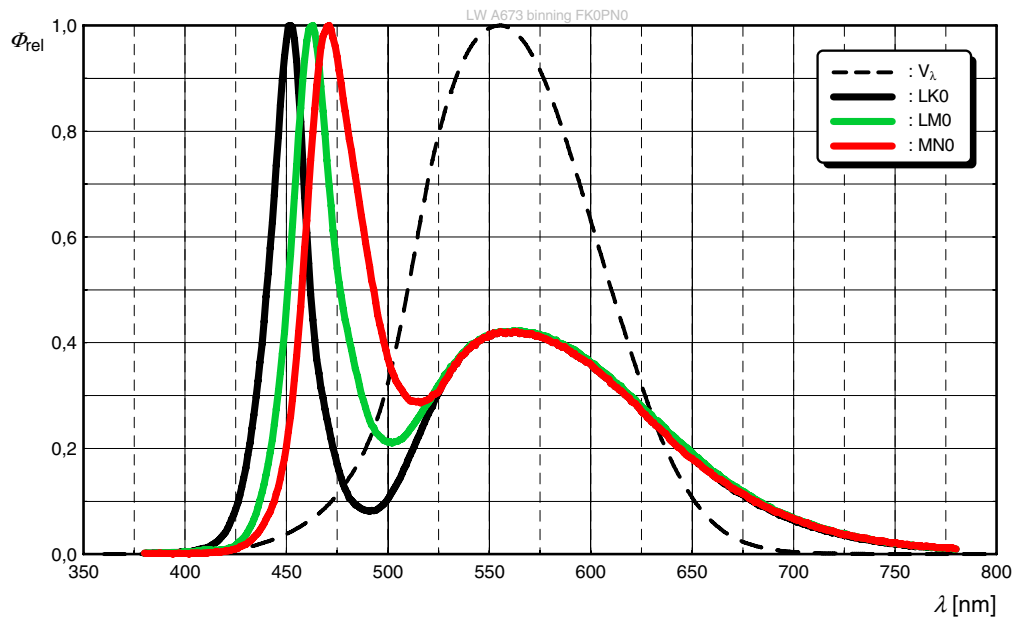

Radiation Characteristics ⁷⁾

$I_{rel} = f(\phi); T_S = 25 \text{ }^\circ\text{C}$

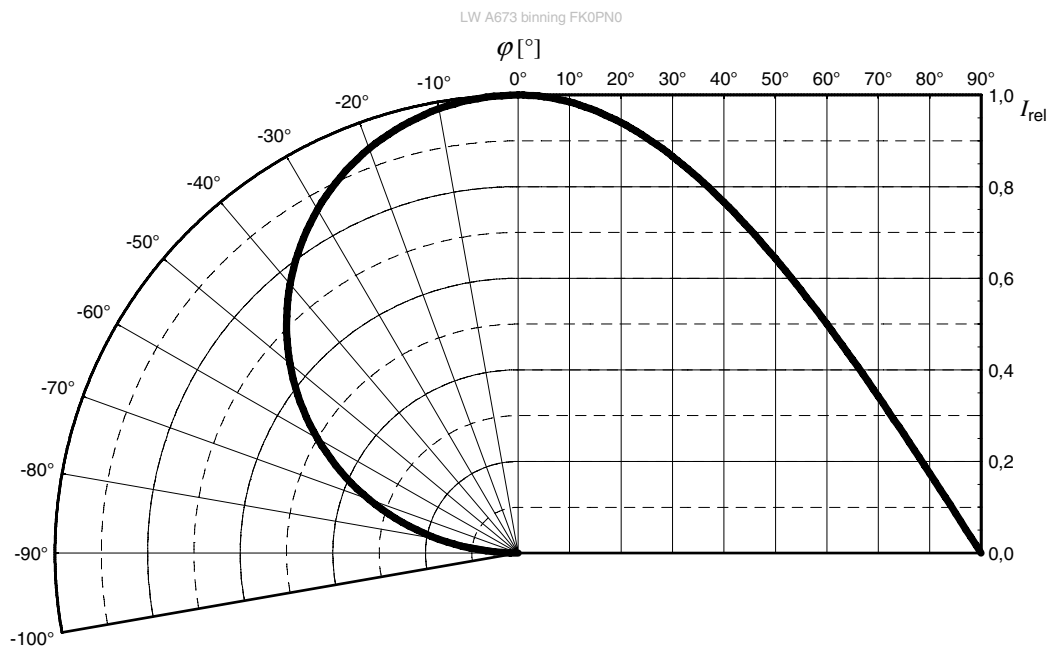

Not for new design

Forward current ⁷⁾

$$I_F = f(V_F); T_S = 25\text{ °C}$$

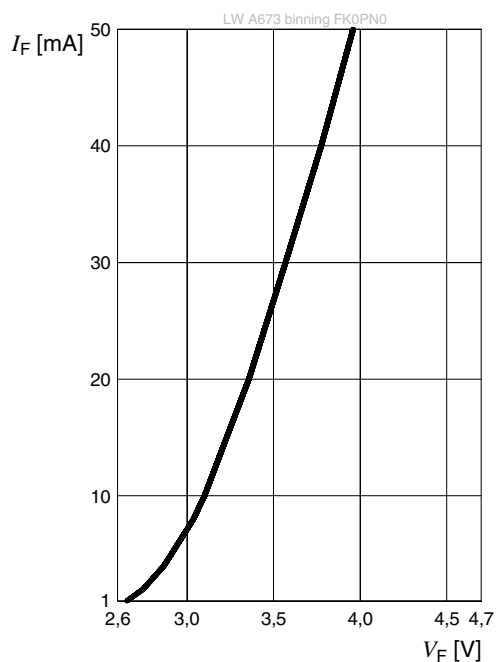

Relative Luminous Intensity ^{7), 8)}

$$I_V/I_V(10\text{ mA}) = f(I_F); T_S = 25\text{ °C}$$

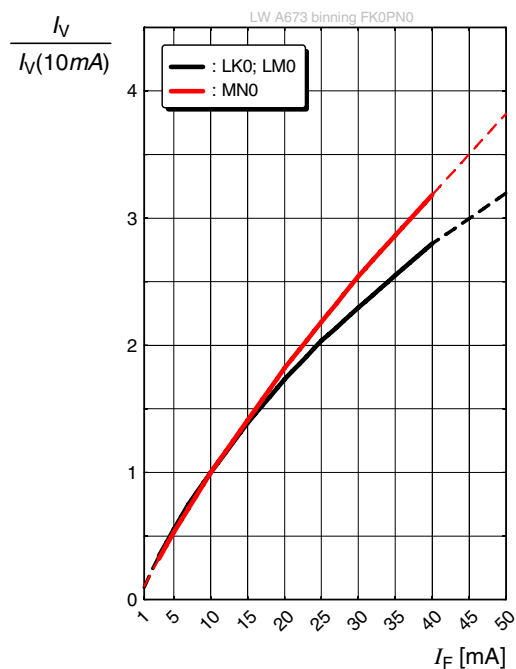

Chromaticity Coordinate Shift ⁷⁾

$$\Delta C_x, \Delta C_y = f(I_F); T_S = 25\text{ °C}$$

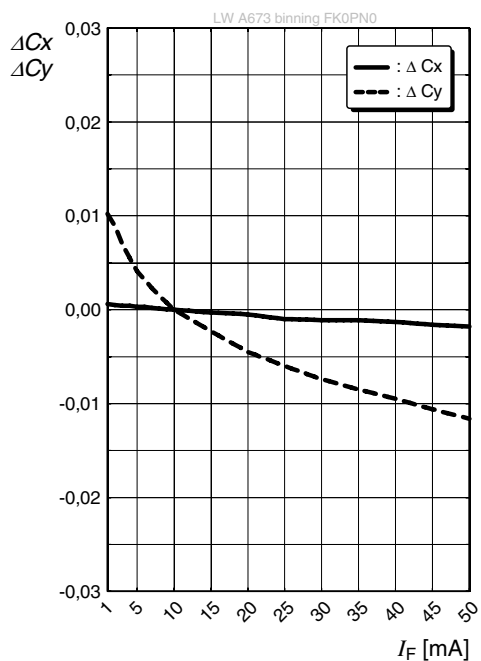

Not for new design

Forward Voltage ⁷⁾

$$\Delta V_F = V_F - V_F(25^\circ\text{C}) = f(T_j); I_F = 10\text{ mA}$$

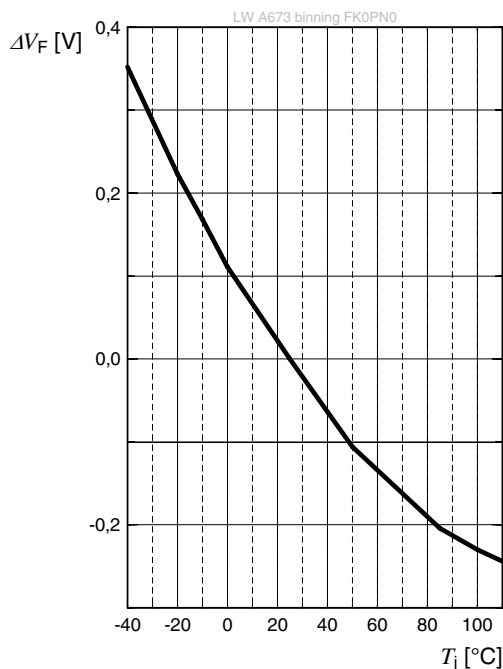

Relative Luminous Intensity ⁷⁾

$$I_V/I_V(25^\circ\text{C}) = f(T_j); I_F = 10\text{ mA}$$

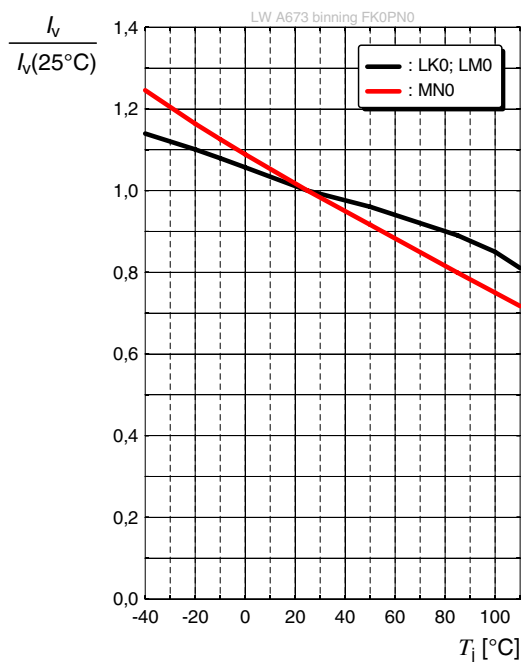

Chromaticity Coordinate Shift ⁷⁾

$$\Delta C_x, \Delta C_y = f(T_j); I_F = 10\text{ mA}$$

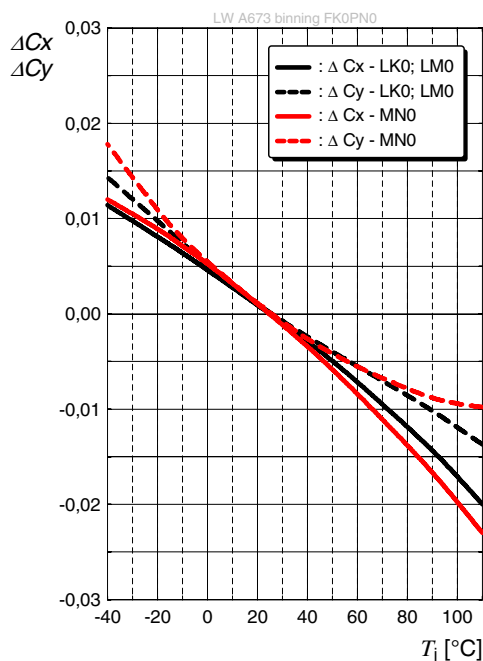

Not for new design

Max. Permissible Forward Current

$I_F = f(T)$

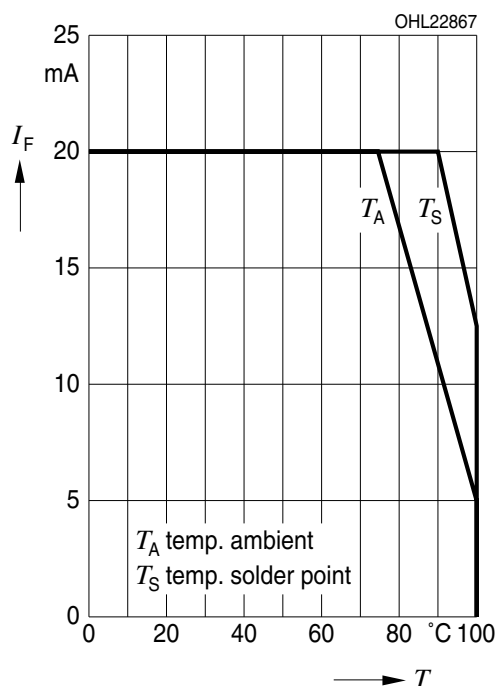

Permissible Pulse Handling Capability

$I_F = f(t_p)$; D: Duty cycle; $T_s = 25\text{ °C}$

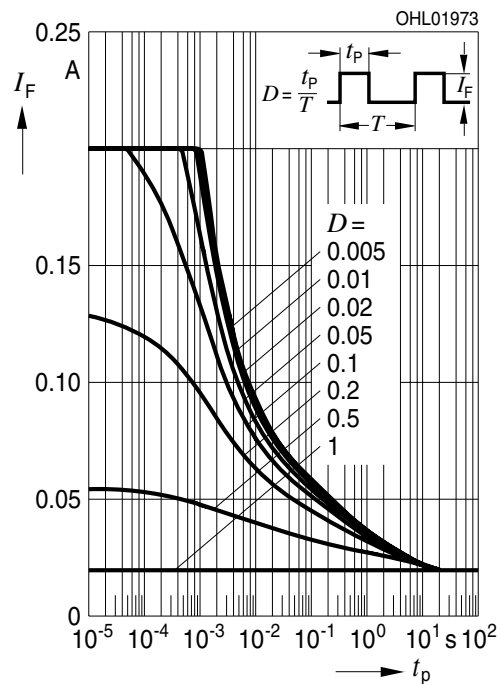

Permissible Pulse Handling Capability

$I_F = f(t_p)$; D: Duty cycle; $T_s = 85\text{ °C}$

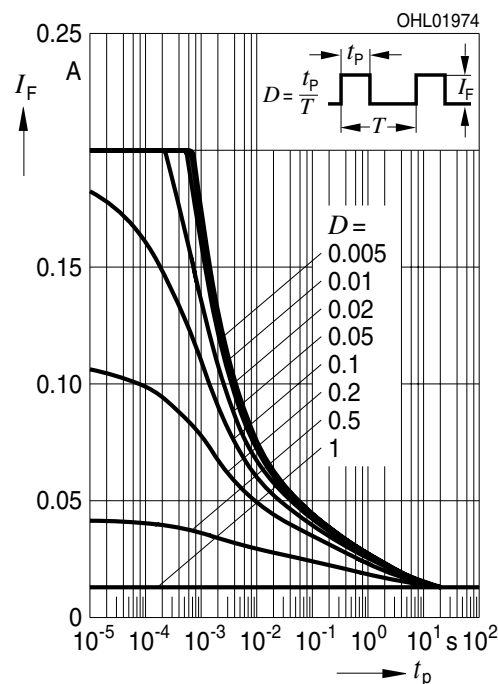

Not for new design

Dimensional Drawing ⁹⁾

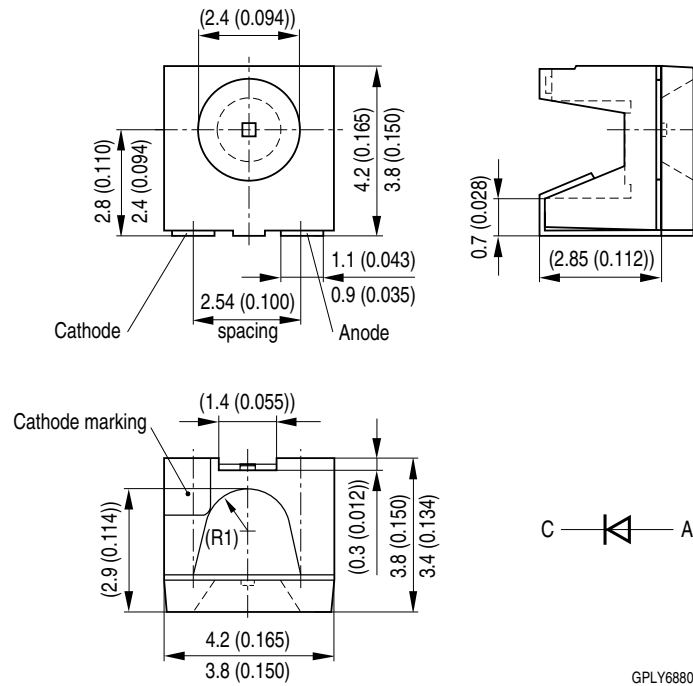

Further Information:

Approximate Weight: 67.0 mg

Corrosion test: Class: 3B
Test condition: 40°C / 90 % RH / 15 ppm H₂S / 14 days (stricter than IEC 60068-2-43)

Recommended Solder Pad ⁹⁾

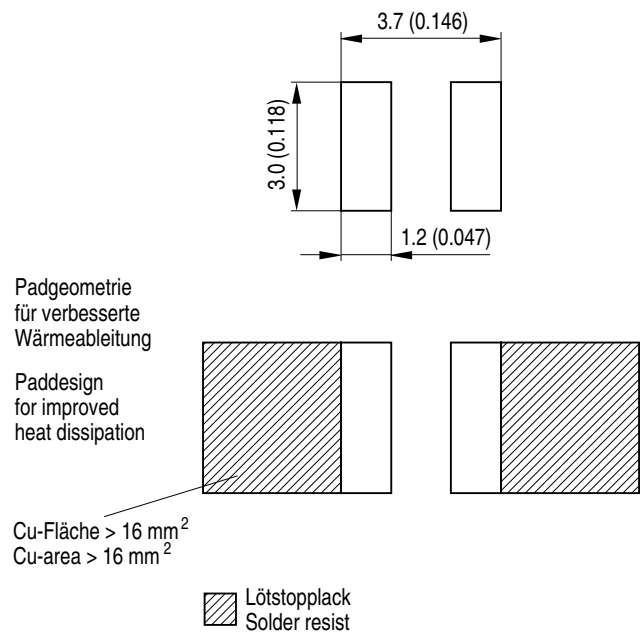

OHLPY965

For superior solder joint connectivity results we recommend soldering under standard nitrogen atmosphere. Package not suitable for ultra sonic cleaning.

Reflow Soldering Profile

Product complies to MSL Level 2 acc. to JEDEC J-STD-020E

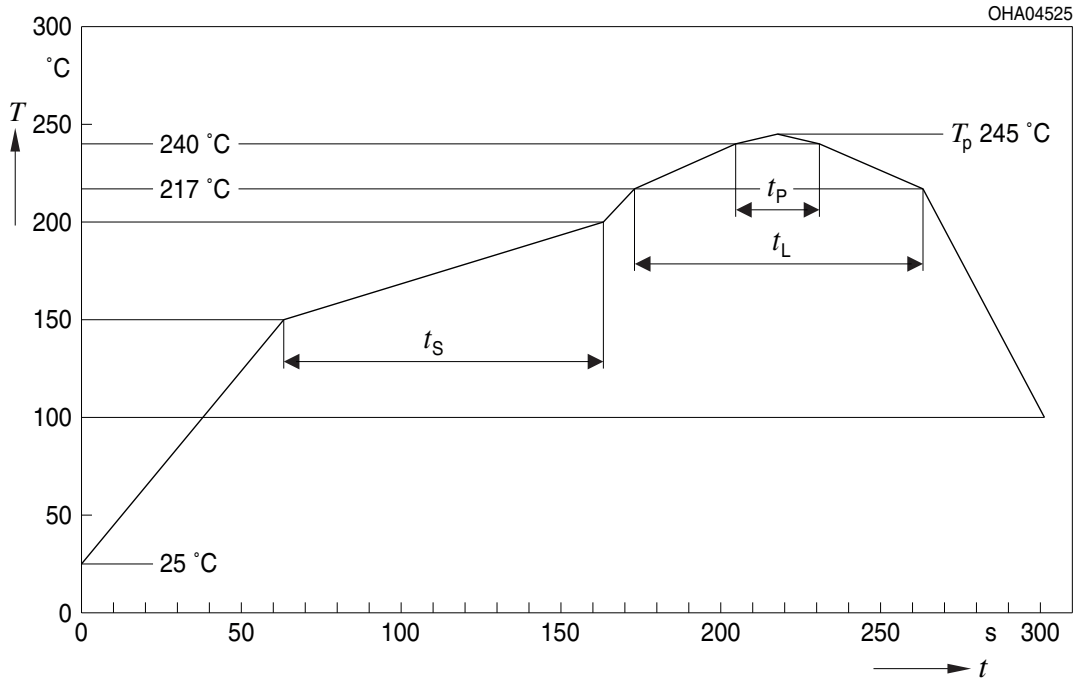

Profile Feature	Symbol	Pb-Free (SnAgCu) Assembly			Unit
		Minimum	Recommendation	Maximum	
Ramp-up rate to preheat ^{*)} 25 °C to 150 °C			2	3	K/s
Time t_s T_{Smin} to T_{Smax}	t_s	60	100	120	s
Ramp-up rate to peak ^{*)} T_{Smax} to T_p			2	3	K/s
Liquidus temperature	T_L		217		°C
Time above liquidus temperature	t_L		80	100	s
Peak temperature	T_p		245	250	°C
Time within 5 °C of the specified peak temperature $T_p - 5$ K	t_p	10	20	30	s
Ramp-down rate* T_p to 100 °C			3	4	K/s
Time 25 °C to T_p				480	s

All temperatures refer to the center of the package, measured on the top of the component
 *) slope calculation DT/Dt : Dt max. 5 s; fulfillment for the whole T-range

Not for new design

Taping ⁹⁾

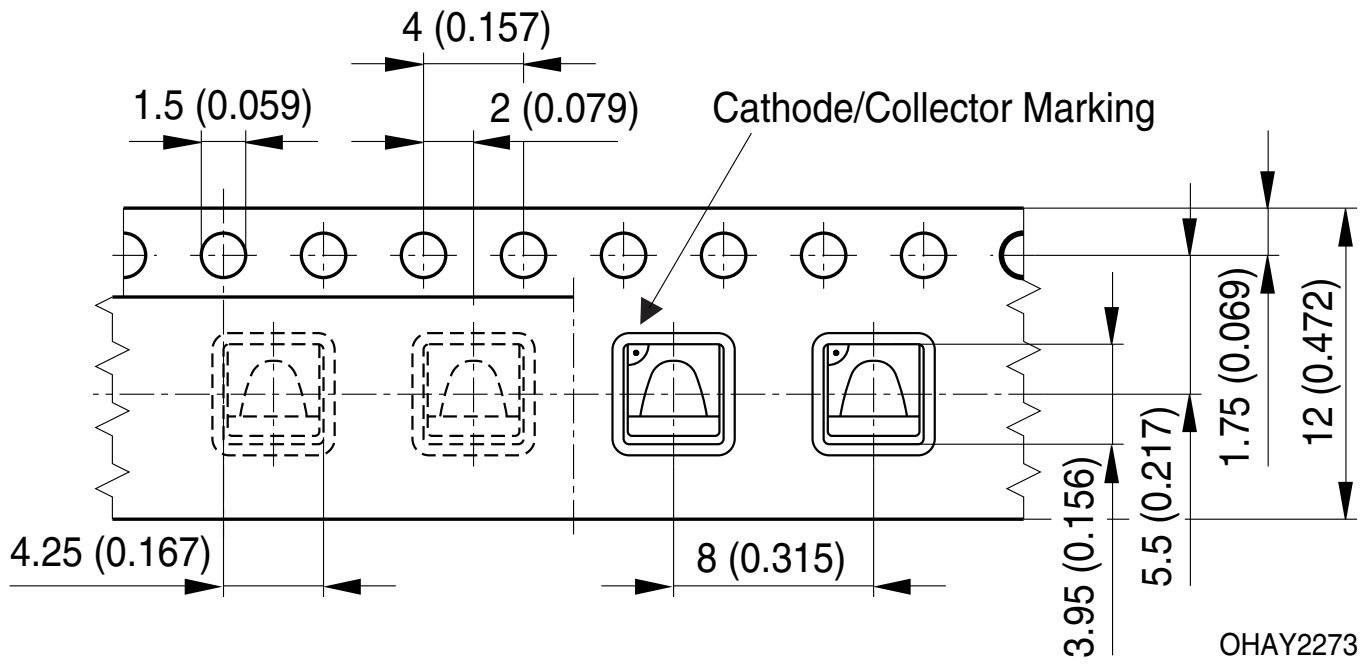

Tape and Reel ¹⁰⁾

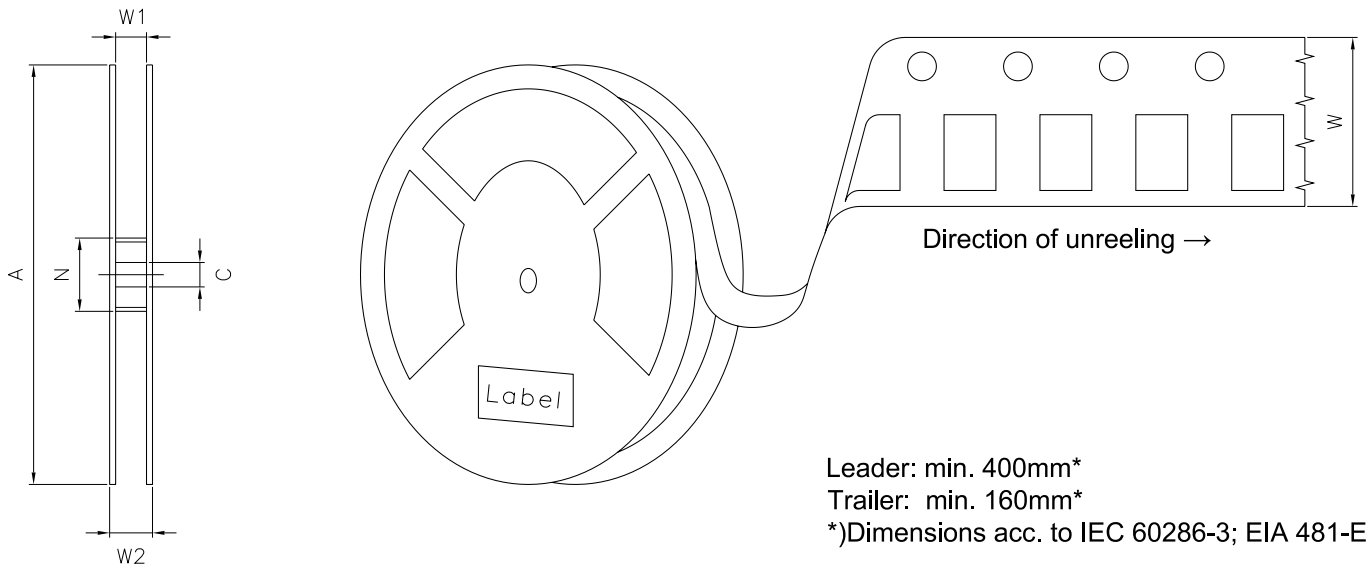

Reel Dimensions



A	W	N _{min}	W ₁	W _{2max}	Pieces per PU
330 mm	12 + 0.3 / - 0.1 mm	60 mm	12.4 + 2 mm	18.4 mm	2000

Barcode-Product-Label (BPL)

OSRAM Opto Semiconductors LX XXXX BIN1: XX-XX-X-XXX-X

RoHS Compliant

(6P) BATCH NO: 1234567890 ML Temp ST
X XXX °C X





(1T) LOT NO: 1234567890 (9D) D/C: 1234



Pack: RXX
DEMY XXX
X_X123_1234.1234 X

(X) PROD NO: 123456789(Q)QTY: 9999 (G) GROUP: XX-XX-X-X



OHA04563

Dry Packing Process and Materials ⁹⁾

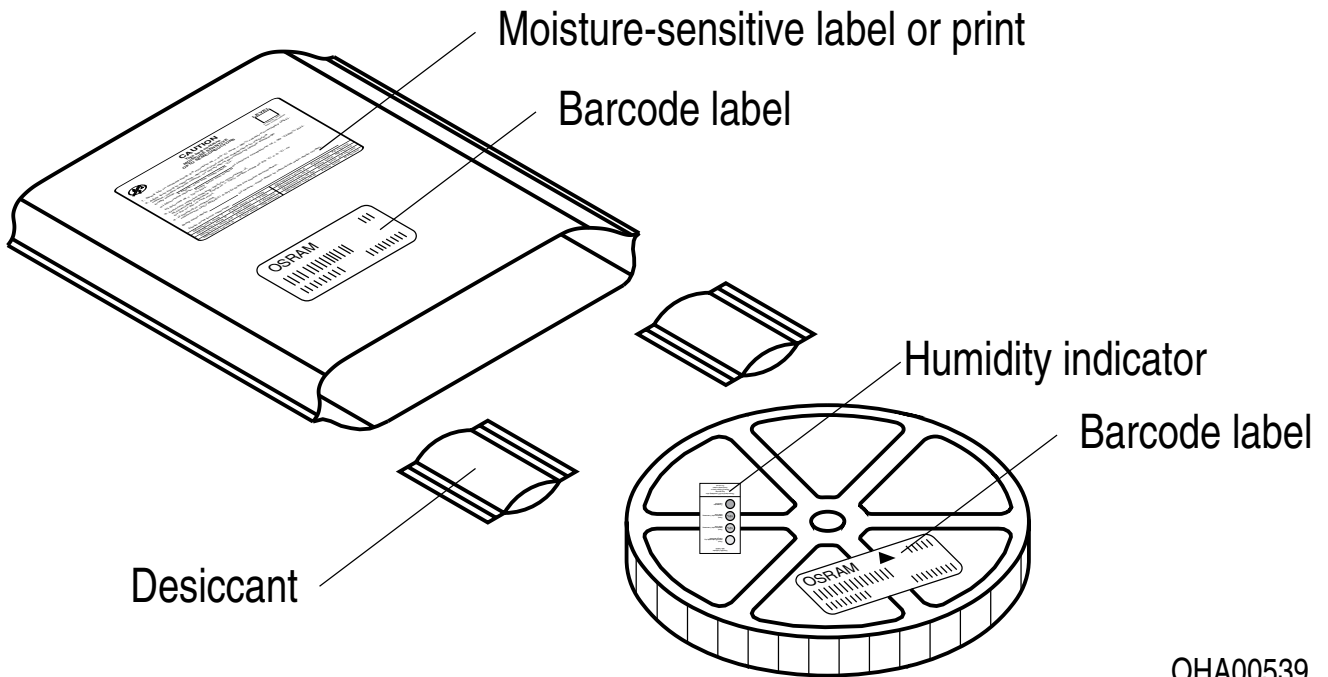

OHA00539

Moisture-sensitive product is packed in a dry bag containing desiccant and a humidity card according JEDEC-STD-033.

Not for new design

Notes

The evaluation of eye safety occurs according to the standard IEC 62471:2006 (photo biological safety of lamps and lamp systems). Within the risk grouping system of this IEC standard, the device specified in this data sheet fall into the class **exempt group (exposure time 10000 s)**. Under real circumstances (for exposure time, conditions of the eye pupils, observation distance), it is assumed that no endangerment to the eye exists from these devices. As a matter of principle, however, it should be mentioned that intense light sources have a high secondary exposure potential due to their blinding effect. When looking at bright light sources (e.g. headlights), temporary reduction in visual acuity and afterimages can occur, leading to irritation, annoyance, visual impairment, and even accidents, depending on the situation.

Subcomponents of this device contain, in addition to other substances, metal filled materials including silver. Metal filled materials can be affected by environments that contain traces of aggressive substances. Therefore, we recommend that customers minimize device exposure to aggressive substances during storage, production, and use. Devices that showed visible discoloration when tested using the described tests above did show no performance deviations within failure limits during the stated test duration. Respective failure limits are described in the IEC60810.

For further application related information please visit www.osram-os.com/appnotes

Disclaimer

Attention please!

The information describes the type of component and shall not be considered as assured characteristics. Terms of delivery and rights to change design reserved. Due to technical requirements components may contain dangerous substances.

For information on the types in question please contact our Sales Organization.

If printed or downloaded, please find the latest version on our website.

Packing

Please use the recycling operators known to you. We can also help you – get in touch with your nearest sales office. By agreement we will take packing material back, if it is sorted. You must bear the costs of transport. For packing material that is returned to us unsorted or which we are not obliged to accept, we shall have to invoice you for any costs incurred.

Product and functional safety devices/applications or medical devices/applications

Our components are not developed, constructed or tested for the application as safety relevant component or for the application in medical devices.

Our products are not qualified at module and system level for such application.

In case buyer – or customer supplied by buyer – considers using our components in product safety devices/ applications or medical devices/applications, buyer and/or customer has to inform our local sales partner immediately and we and buyer and /or customer will analyze and coordinate the customer-specific request between us and buyer and/or customer.

Glossary

- 1) **Brightness:** Brightness values are measured during a current pulse of typically 25 ms, with an internal reproducibility of $\pm 8\%$ and an expanded uncertainty of $\pm 11\%$ (acc. to GUM with a coverage factor of $k = 3$).
- 2) **Reverse Operation:** This product is intended to be operated applying a forward current within the specified range. Applying any continuous reverse bias or forward bias below the voltage range of light emission shall be avoided because it may cause migration which can change the electro-optical characteristics or damage the LED.
- 3) **Chromaticity coordinate groups:** Chromaticity coordinates are measured during a current pulse of typically 25 ms, with an internal reproducibility of ± 0.005 and an expanded uncertainty of ± 0.01 (acc. to GUM with a coverage factor of $k = 3$).
- 4) **Forward Voltage:** The forward voltage is measured during a current pulse of typically 8 ms, with an internal reproducibility of ± 0.05 V and an expanded uncertainty of ± 0.1 V (acc. to GUM with a coverage factor of $k = 3$).
- 5) **Thermal Resistance:** $R_{th\ max}$ is based on statistic values (6σ).
- 6) **Thermal Resistance:** R_{thJA} results from mounting on PC board FR 4 (pad size 16 mm² per pad)
- 7) **Typical Values:** Due to the special conditions of the manufacturing processes of semiconductor devices, the typical data or calculated correlations of technical parameters can only reflect statistical figures. These do not necessarily correspond to the actual parameters of each single product, which could differ from the typical data and calculated correlations or the typical characteristic line. If requested, e.g. because of technical improvements, these typ. data will be changed without any further notice.
- 8) **Characteristic curve:** In the range where the line of the graph is broken, you must expect higher differences between single devices within one packing unit.
- 9) **Tolerance of Measure:** Unless otherwise noted in drawing, tolerances are specified with ± 0.1 and dimensions are specified in mm.
- 10) **Tape and Reel:** All dimensions and tolerances are specified acc. IEC 60286-3 and specified in mm.

Revision History

Version	Date	Change
1.1	2020-09-21	Features Schematic Transportation Box Dimensions of Transportation Box
1.2	2022-04-21	Not for new design New Layout

Not for new design



EU RoHS and China RoHS compliant product

此产品符合欧盟 RoHS 指令的要求；
按照中国的相关法规和标准，
不含有毒有害物质或元素。

Published by ams-OSRAM AG

Tobelbader Strasse 30, 8141 Premstaetten, Austria

Phone +43 3136 500-0

ams-osram.com

© All rights reserved

am 

OSRAM