

CIRCUIT	PART NO.	DIM A	COLOR
2	171692-0202	8.35	BLACK
4	171692-0204	12.05	
6	171692-0206	17.75	
8	171692-0208	23.45	
10	171692-0210	29.15	
12	171692-0212	34.85	

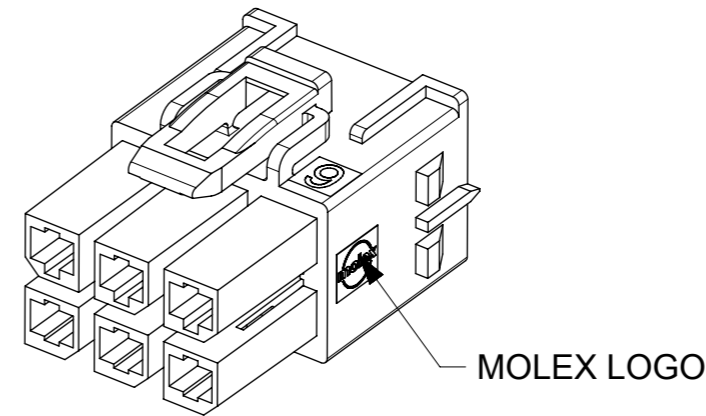

NOTES:

- MATERIAL:**
 NYLON, UL 94V-0 AND GLOW WIRE CAPABLE PER IEC60335-1.
 COLOR: BLACK.
- PART USED WITH MOLEX SERIES:**
 HEADER: 76829, 172065; 76825, 172064
 PLUG: 105411
 TPA-CAPABLE FEMALE TERMINAL: 76823, 172063
 TPA: 105415
- PRODUCT SPECIFICATION:** 1054171000-PS/1720631000-PS.
- PAKAGING SPECIFICATION:** 1716920200.
- APPLICATION SPECIFICATION:** 768232000-AS

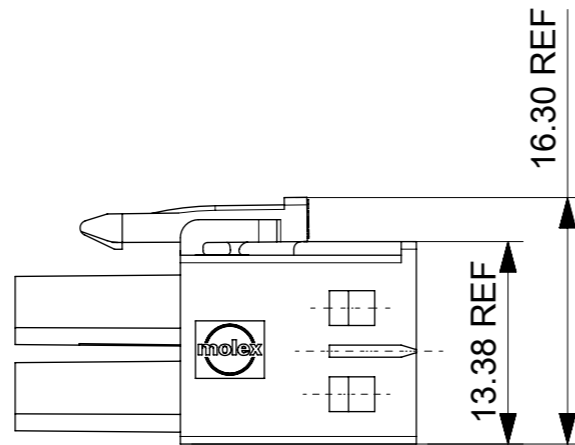
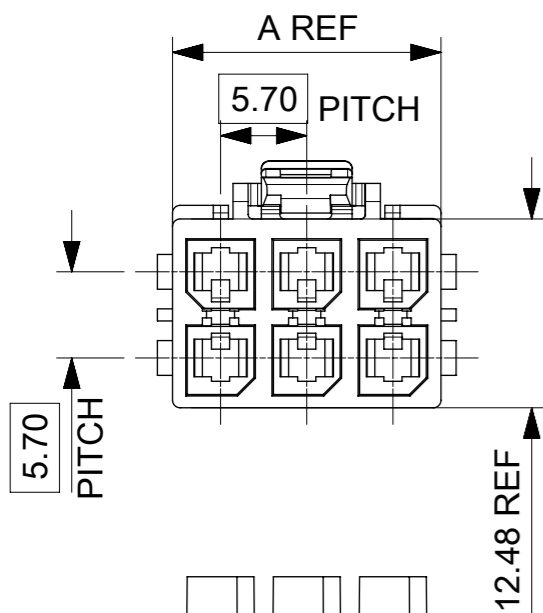
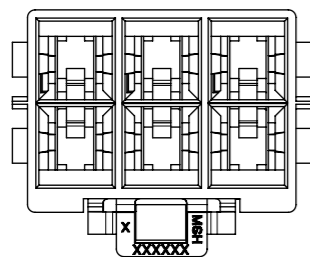
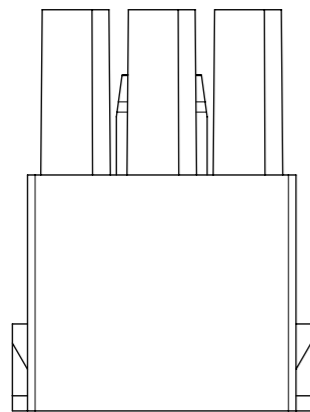

THIS DRAWING CONTAINS INFORMATION THAT IS PROPRIETARY TO MOLEX ELECTRONIC TECHNOLOGIES, LLC AND SHOULD NOT BE USED WITHOUT WRITTEN PERMISSION									
DIMENSION UNITS		SCALE		CURRENT REV DESC:				molex	
mm		NTS							
GENERAL TOLERANCES (UNLESS SPECIFIED)									
ANGULAR TOL ± 3.0°									
4 PLACES		±		EC NO: 704917				MEGA-FIT RECEPTACLE DR TPA	
3 PLACES		±		DRWN: XQZHANG 2022/04/28					
2 PLACES		± 0.25		CHK'D: XQZHANG 2022/04/28					
1 PLACE		± 0.35		APPR: XQZHANG 2022/04/28				PRODUCT CUSTOMER DRAWING	
0 PLACES		±		INITIAL REVISION:					
DRAFT WHERE APPLICABLE MUST REMAIN WITHIN DIMENSIONS		THIRD ANGLE PROJECTION		DRAWING		SERIES		DOCUMENT NUMBER	
		A3-SIZE		171692		2016/12/15		1716920200	
						2018/08/06		PSD 000 E1	
								SHEET NUMBER	
								1 OF 2	

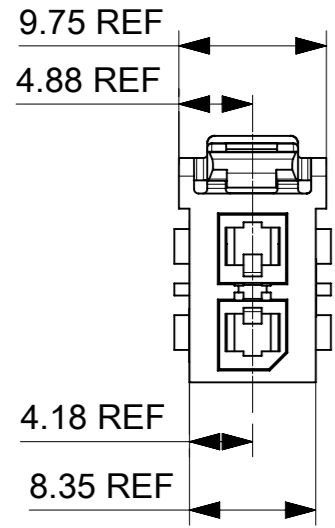

2 CKT

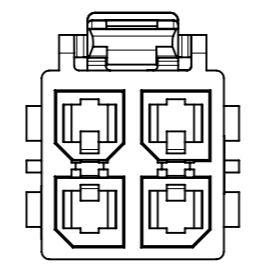
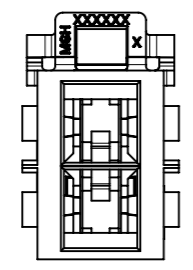

4 CKT

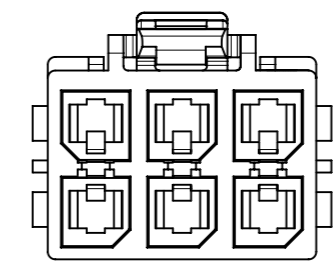
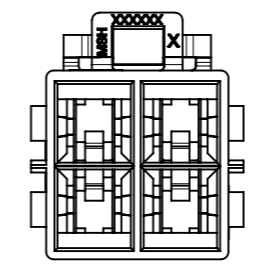

6 CKT

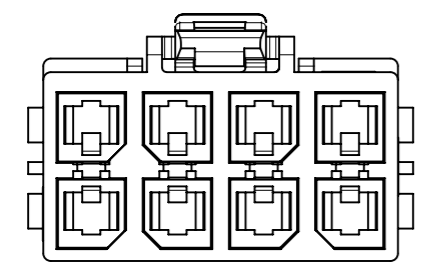
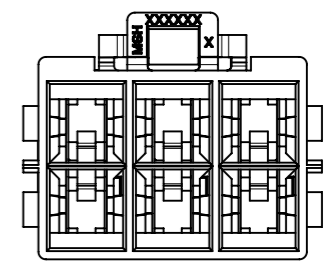

8 CKT

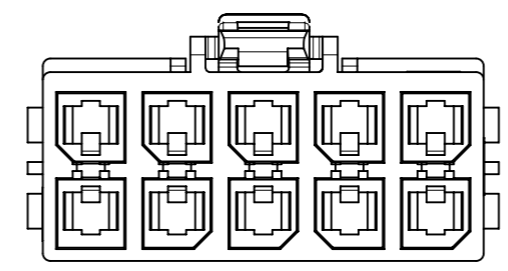
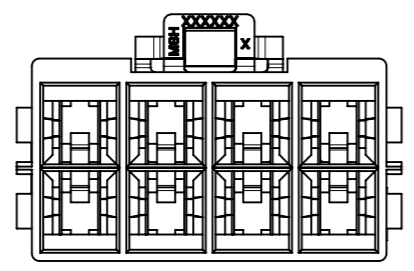

10 CKT

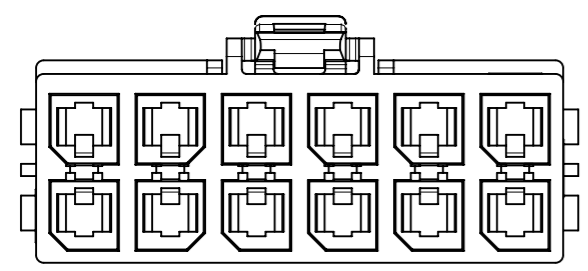
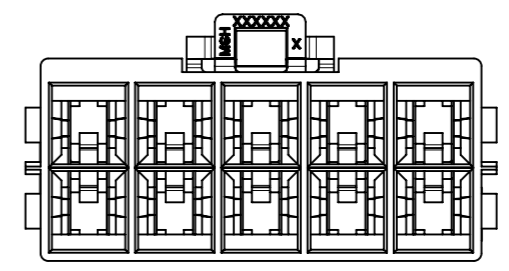

12 CKT

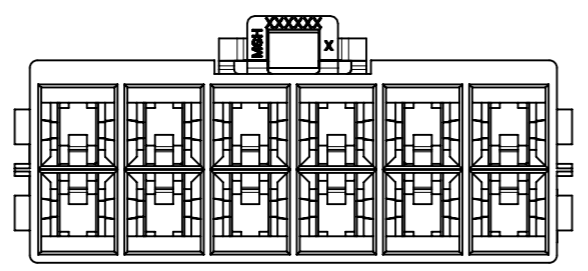

THIS DRAWING CONTAINS INFORMATION THAT IS PROPRIETARY TO MOLEX ELECTRONIC TECHNOLOGIES, LLC AND SHOULD NOT BE USED WITHOUT WRITTEN PERMISSION									
DIMENSION UNITS		SCALE		CURRENT REV DESC:				molex	
mm		NTS							
GENERAL TOLERANCES (UNLESS SPECIFIED)				EC NO: 704917				MEGA-FIT RECEPTACLE DR TPA	
ANGULAR TOL ± 3.0 °				DRWN: XQZHANG 2022/04/28				PRODUCT CUSTOMER DRAWING	
4 PLACES ±				CHK'D: XQZHANG 2022/04/28				DOCUMENT NUMBER	
3 PLACES ±				APPR: XQZHANG 2022/04/28				1716920200	
2 PLACES ± 0.25				INITIAL REVISION:				DOC TYPE	
1 PLACE ± 0.35				DRWN: YXZHENG 2016/12/15				PSD	
0 PLACES ±				APPR: YXZHENG 2018/08/06				DOC PART	
DRAFT WHERE APPLICABLE MUST REMAIN WITHIN DIMENSIONS				THIRD ANGLE PROJECTION		DRAWING		REVISION	
				A3-SIZE		SERIES		SHEET NUMBER	
				171692		MATERIAL NUMBER		2 OF 2	
				SEE TABLE		CUSTOMER			
						GENERAL MARKET			