

Inductive sensor

NMB5-12GM65-E2-C-V1



- 5 mm flush
- Stainless steel sensing face
- Increased operating distance
- Weld Immune



Dimensions

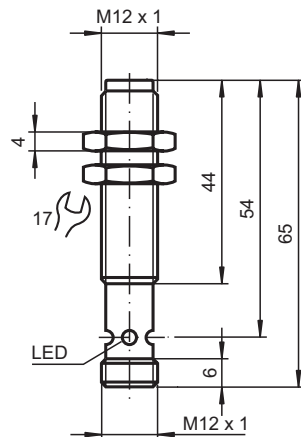

Technical Data

General specifications

Switching function		Normally open (NO)
Output type		PNP
Rated operating distance	s_n	5 mm
Installation		flush (Requirements: see drawing below)
Output polarity		DC
Assured operating distance	s_a	0 ... 4.05 mm
Actuating element		Ferrous and nonferrous targets
Reduction factor r_{Al}		0.3
Reduction factor r_{Cu}		0.2
Reduction factor r_{304}		0.85
Reduction factor r_{St37}		1
Output type		3-wire

Nominal ratings

Operating voltage	U_B	10 ... 30 V DC
-------------------	-------	----------------

Release date: 2022-08-04 Date of issue: 2022-08-04 Filename: 911268_eng.pdf

Refer to "General Notes Relating to Pepperl+Fuchs Product Information".

Pepperl+Fuchs Group
www.pepperl-fuchs.com

USA: +1 330 486 0001
fa-info@us.pepperl-fuchs.com

Germany: +49 621 776 1111
fa-info@de.pepperl-fuchs.com

Singapore: +65 6779 9091
fa-info@sg.pepperl-fuchs.com

PF PEPPERL+FUCHS

Technical Data

Switching frequency	f	0 ... 5 Hz
Hysteresis	H	3 ... 15 typ. 5 %
Reverse polarity protection		reverse polarity protected
Short-circuit protection		pulsing
Voltage drop	U_d	≤ 2 V
Operating current	I_L	≤ 200 mA
Current consumption		≤ 10 mA
Off-state current	I_r	≤ 10 μ A
No-load supply current	I_0	≤ 15 mA
Operating voltage indicator		LED, green
Switching state indicator		Multihole-LED, yellow
Mag. Field strength, AC fields		250 mT
Mag. Field strength, DC fields		250 mT

Compliance with standards and directives

Standard conformity		
Standards		EN 60947-5-2:2007 IEC 60947-5-2:2007

Approvals and certificates

UL approval		cULus Listed, General Purpose
CSA approval		cCSAus Listed, General Purpose
CCC approval		CCC approval / marking not required for products rated ≤ 36 V

Ambient conditions

Ambient temperature		-25 ... 70 °C (-13 ... 158 °F)
---------------------	--	--------------------------------

Mechanical specifications

Connection type		Connector plug M12 x 1 , 4-pin
Housing material		Xylan coated - Stainless steel 1.4305 / AISI 303
Sensing face		Xylan coated - Stainless steel 1.4305 / AISI 303
Degree of protection		IP67 / IP68 / IP69K - cordset dependent according to cable specification

Connection

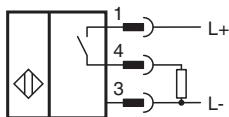

Connection Assignment

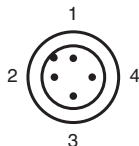

Connection Assignment

Wire colors in accordance with EN 60947-5-2

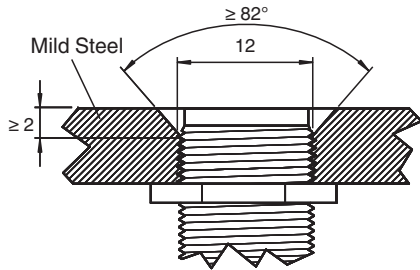

1	BN	(brown)
2	WH	(white)
3	BU	(blue)
4	BK	(black)

Mounting



Sensor face is flush with mounting surface.

Accessories

	BF 12	Mounting flange, 12 mm
	AB-12	Mounting aid
	V1-G-OR2M-POC	Female cordset single-ended M12 straight A-coded, 4-pin, POC cable welding-bead resistant orange, suitable for robotic applications, torsion resistant, oil resistant, molecularly cross-linked

Release date: 2022-08-04 Date of issue: 2022-08-04 Filename: 911268_eng.pdf