

XC40S-1803A0A00BA0

C4000 Select

SAFETY LIGHT CURTAINS

SICK
Sensor Intelligence.

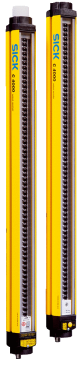

Ordering information

| Type | Part no. |
|--------------------|----------|
| XC40S-1803A0A00BA0 | 1204164 |

Other models and accessories → www.sick.com/C4000_Select



Detailed technical data

Features

| | |
|---------------------------------------|-------------------------|
| System part | Sender |
| Resolution | 30 mm |
| Protective field height | 1,800 mm |
| Scanning range | 21 m |
| Synchronization | Optical synchronisation |
| Integrated laser alignment aid | ✓ |

Safety-related parameters

| | |
|---|--|
| Type | Type 4 (IEC 61496-1) |
| Safety integrity level | SIL3 (IEC 61508) SILCL3 (EN 62061) |
| Category | Category 4 (EN ISO 13849) |
| Performance level | PL e (EN ISO 13849) |
| PFH_D (mean probability of a dangerous failure per hour) | 3.2×10^{-8} (EN ISO 13849) |
| T_M (mission time) | 20 years (EN ISO 13849) |
| Safe state in the event of a fault | At least one OSSD is in the OFF state. |

Functions

| | Functions | Delivery status |
|------------------------------------|-----------|-----------------|
| Beam coding | ✓ | Uncoded |
| Configurable scanning range | ✓ | |
| Floating blanking | ✓ | |

Interfaces

| | |
|--------------------------|---------------------------|
| System connection | |
| Connection type | Male connector M12, 5-pin |

¹⁾ Depending on load, power supply and wire cross-section. The technical specifications must be observed.

²⁾ For additional information on Flexi Soft -> www.sick.com/Flexi_Soft.

| | |
|--|---|
| Permitted cable length | ≤ 30 m ¹⁾ |
| Extension connection | |
| Connection type | Female connector M12, 5-pin |
| Configuration connection | |
| Configuration method | DIP switch |
| Display elements | 7-segment display |
| Fieldbus, industrial network | |
| Integration via Flexi Soft safety controller | CANopen, DeviceNet™, EtherCAT®, EtherNet/IP™, Modbus TCP, PROFIBUS DP, PROFINET ²⁾ |

¹⁾ Depending on load, power supply and wire cross-section. The technical specifications must be observed.

²⁾ For additional information on Flexi Soft -> www.sick.com/Flexi_Soft.

Electrical data

| | |
|-------------------------------------|---|
| Protection class | III (IEC 61140) |
| Supply voltage V_S | 24 V DC (19.2 V ... 28.8 V) ¹⁾ |
| Residual ripple | ≤ 10 % ²⁾ |
| Power consumption | ≤ 6.9 W |

¹⁾ The external voltage supply must be capable of buffering brief mains voltage failures of 20 ms as specified in EN 60204-1. Suitable power supplies are available as accessories from SICK.

²⁾ Within the limits of V_S.

Mechanical data

| | |
|-------------------------|---------------------------|
| Dimensions | See dimensional drawing |
| Housing material | Aluminum alloy ALMGSI 0.5 |

Ambient data

| | |
|--------------------------------------|-------------------------------------|
| Enclosure rating | IP65 (EN 60529) |
| Ambient operating temperature | 0 °C ... +55 °C |
| Storage temperature | -25 °C ... +70 °C |
| Air humidity | 15 % ... 95 %, Non-condensing |
| Vibration resistance | 5 g, 10 Hz ... 55 Hz (EN 60068-2-6) |
| Shock resistance | 10 g, 16 ms (EN 60068-2-27) |

Other information

| | |
|---------------------------------------|---------------------------|
| Wave length | 950 nm |
| Integrated laser alignment aid | ✓ |
| Light source | LED |
| Laser class | 1 (IEC 60825-1), eye-safe |
| Type of light | Visible red light |

Classifications

| | |
|---------------------|----------|
| ECl@ss 5.0 | 27272704 |
| ECl@ss 5.1.4 | 27272704 |
| ECl@ss 6.0 | 27272704 |
| ECl@ss 6.2 | 27272704 |
| ECl@ss 7.0 | 27272704 |
| ECl@ss 8.0 | 27272704 |

| | |
|-----------------------|----------|
| ECl@ss 8.1 | 27272704 |
| ECl@ss 9.0 | 27272704 |
| ETIM 5.0 | EC002549 |
| ETIM 6.0 | EC002549 |
| UNSPSC 16.0901 | 46171620 |

Dimensional drawing (Dimensions in mm (inch))

Sender

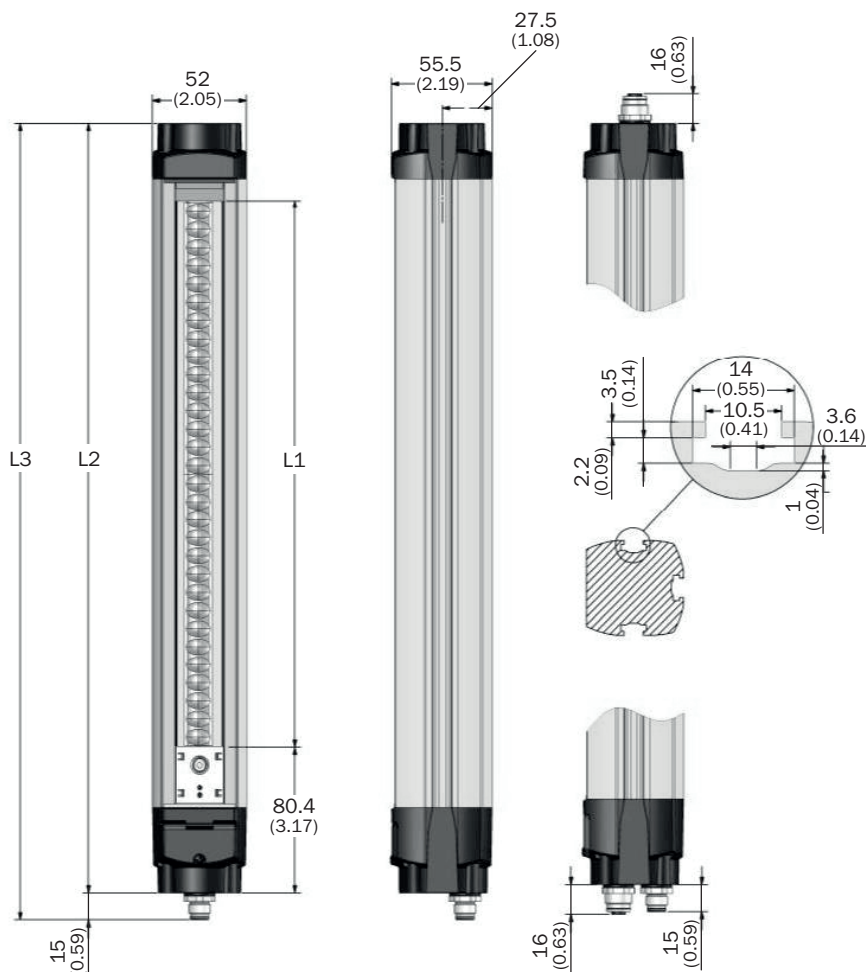







| Protective field height S | L1 | L2 | L3 |
|---------------------------|---------------|---------------|---------------|
| 300 (11.81) | 302 (11.89) | 425 (16.73) | 440 (17.32) |
| 450 (17.72) | 452 (17.80) | 575 (22.64) | 590 (23.23) |
| 600 (23.62) | 602 (23.70) | 725 (28.54) | 740 (29.13) |
| 750 (29.53) | 752 (29.61) | 875 (34.45) | 890 (35.04) |
| 900 (35.43) | 902 (35.51) | 1,025 (40.35) | 1,040 (40.94) |
| 1,050 (41.34) | 1,052 (41.42) | 1,175 (46.26) | 1,190 (46.85) |
| 1,200 (47.24) | 1,202 (47.32) | 1,325 (52.17) | 1,340 (52.76) |
| 1,350 (53.15) | 1,352 (53.23) | 1,475 (58.07) | 1,490 (58.66) |

| Protective field height S | L1 | L2 | L3 |
|---------------------------|---------------|---------------|---------------|
| 1,500 (59.06) | 1,502 (59.13) | 1,625 (63.98) | 1,640 (64.57) |
| 1,650 (64.96) | 1,652 (65.04) | 1,775 (69.88) | 1,790 (70.47) |
| 1,800 (70.87) | 1,802 (70.94) | 1,925 (75.79) | 1,940 (76.38) |

Recommended accessories

Other models and accessories → www.sick.com/C4000_Select

| | Brief description | Type | Part no. |
|---|--|--------------------|----------|
| Mounting brackets and plates | | | |
|  | 4 pieces, Mounting kit 1, mounting bracket, rigid, L-shaped, including fixing screws and washers | BEF-3WNGBAST4 | 7021352 |
| Terminal and alignment brackets | | | |
|  | 4 pieces, Mounting kit 6, side bracket, rotatable, Zinc diecast | BEF-1SHABAZN4 | 2019506 |
|  | 4 pieces, Mounting kit 12, rotatable, swivel mount | BEF-2SMGEAKU4 | 2030510 |
| Plug connectors and cables | | | |
|  | Head A: female connector, M12, 5-pin, straight, A-coded Head B: male connector, M12, 5-pin, straight, A-coded Cable: Sensor/actuator cable, PUR, halogen-free, unshielded, 2 m | YF2A15-020UB5M2A15 | 2096009 |
| Alignment aids | | | |
|  | Laser alignment aid for various sensors, laser class 2 (IEC 60825). Do not look into the beam! | AR60 | 1015741 |
| Optics cloths | | | |
|  | Cloth for cleaning optical surfaces | Lens cloth | 4003353 |
| Cleaning agent | | | |
|  | Plastic cleaner and care product, anti-static, 0.5 liter | Plastic cleaner | 5600006 |

SICK AT A GLANCE

SICK is one of the leading manufacturers of intelligent sensors and sensor solutions for industrial applications. A unique range of products and services creates the perfect basis for controlling processes securely and efficiently, protecting individuals from accidents and preventing damage to the environment.

We have extensive experience in a wide range of industries and understand their processes and requirements. With intelligent sensors, we can deliver exactly what our customers need. In application centers in Europe, Asia and North America, system solutions are tested and optimized in accordance with customer specifications. All this makes us a reliable supplier and development partner.

Comprehensive services complete our offering: SICK LifeTime Services provide support throughout the machine life cycle and ensure safety and productivity.

For us, that is “Sensor Intelligence.”

WORLDWIDE PRESENCE:

Contacts and other locations –www.sick.com