



ESSENTIAL INFORMATION

- BUILD INSTRUCTIONS
- CHECKING YOUR PCB & FAULT-FINDING
- EXAMPLE PROGRAMMING
- HOW THE KIT WORKS

TAKE CONTROL OF THE TRAFFIC WITH THIS

STOP:bit for BBC MICRO:BIT KIT

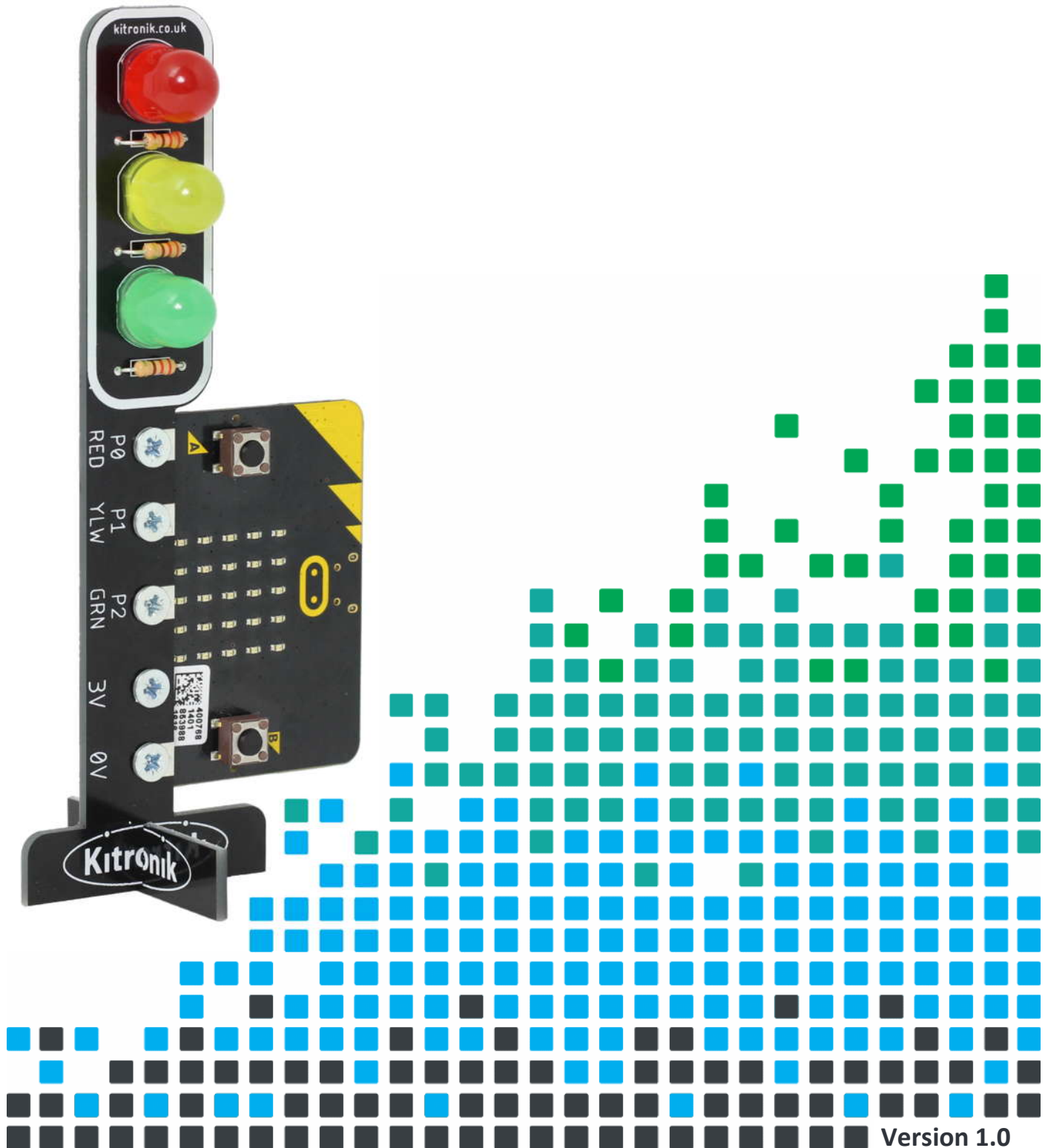

Build Instructions

Before you start, take a look at the Printed Circuit Board (PCB). The components go in the side with the names and outlines, and the solder goes on the side with the tracks and product name (refer to 'Soldering in 8 Steps').

1 SOLDER THE RESISTORS

1

Start with the resistors. The text on the PCB shows where R1, R2 etc go. Ensure that you put the resistors in the right place.

PCB Ref	Value	Colour Bands
R1, R2, R3	220Ω	Red, Red, Brown



2 SOLDER THE LEDs

2

Place the Red LED into LED1, the Yellow LED into LED2 and the Green LED into LED3. Make sure that the short leg is placed in the – hole on each one.

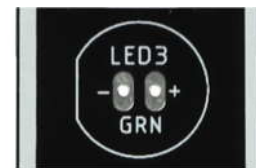
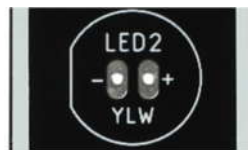

3 ATTACH THE BASE

3

Carefully snap off the slot-in base section from the bottom of the PCB (see images below).

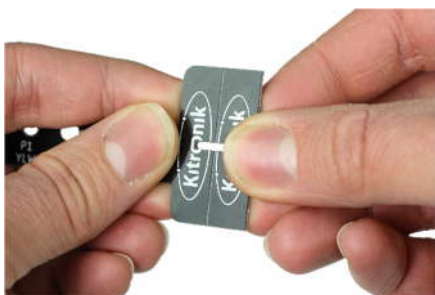

Slot the two sections together, making sure that 'Kitronik' is readable.



Checking Your PCB

Check the following before you program and power up the unit:

Check the bottom of the board to ensure that:

- All holes (except the large mounting holes) are filled with the lead of a component.
- All these leads are soldered.
- Pins next to each other are not soldered together.

Check the top of the board to ensure that:

- The resistor bands on R1, R2 and R3 are Red, Red, Brown
- The Red LED is in the top position on the PCB
- The Yellow LED is in the middle position on the PCB
- The Green LED is in the bottom position on the PCB



STOP:bit Kit Essentials

www.kitronik.co.uk/5642K



4

ATTACH THE BBC MICRO:BIT

Using the provided M3 nuts and bolts, attach the BBC micro:bit to the STOP:bit PCB. Make sure the BBC micro:bit is on the back of the PCB.



5

WRITE A MAKECODE PROGRAM FOR THE STOP:BIT

Open a web browser, go to 'makecode.microbit.org', and start a new project. Click on 'Advanced' and then 'Extensions'. Search for 'Kitronik' and add the 'kitronik-stopbit' extension (shown in the image to the right) – this will enable the STOP:bit to be controlled. Create the simple program shown here which runs through the standard traffic light pattern.

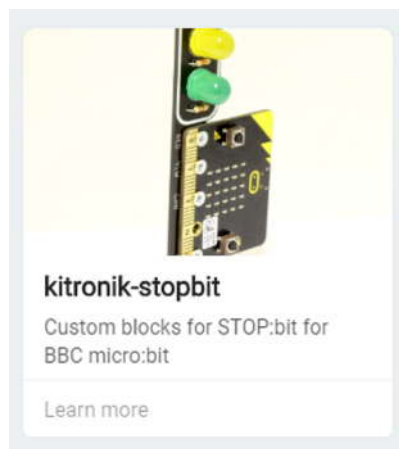

6

PROGRAM THE BBC MICRO:BIT

Give your MakeCode program an appropriate name and connect the BBC micro:bit to the computer using a standard micro-USB cable.

STOPbit Kit Example

Then, depending on which web browser is being used, either save the program directly to the attached BBC micro:bit or save to the computer (the file will appear in the 'Downloads' folder). After going to the 'Downloads' folder, the program files can then be dragged and dropped into the 'MICROBIT' storage device.

Let the program run!



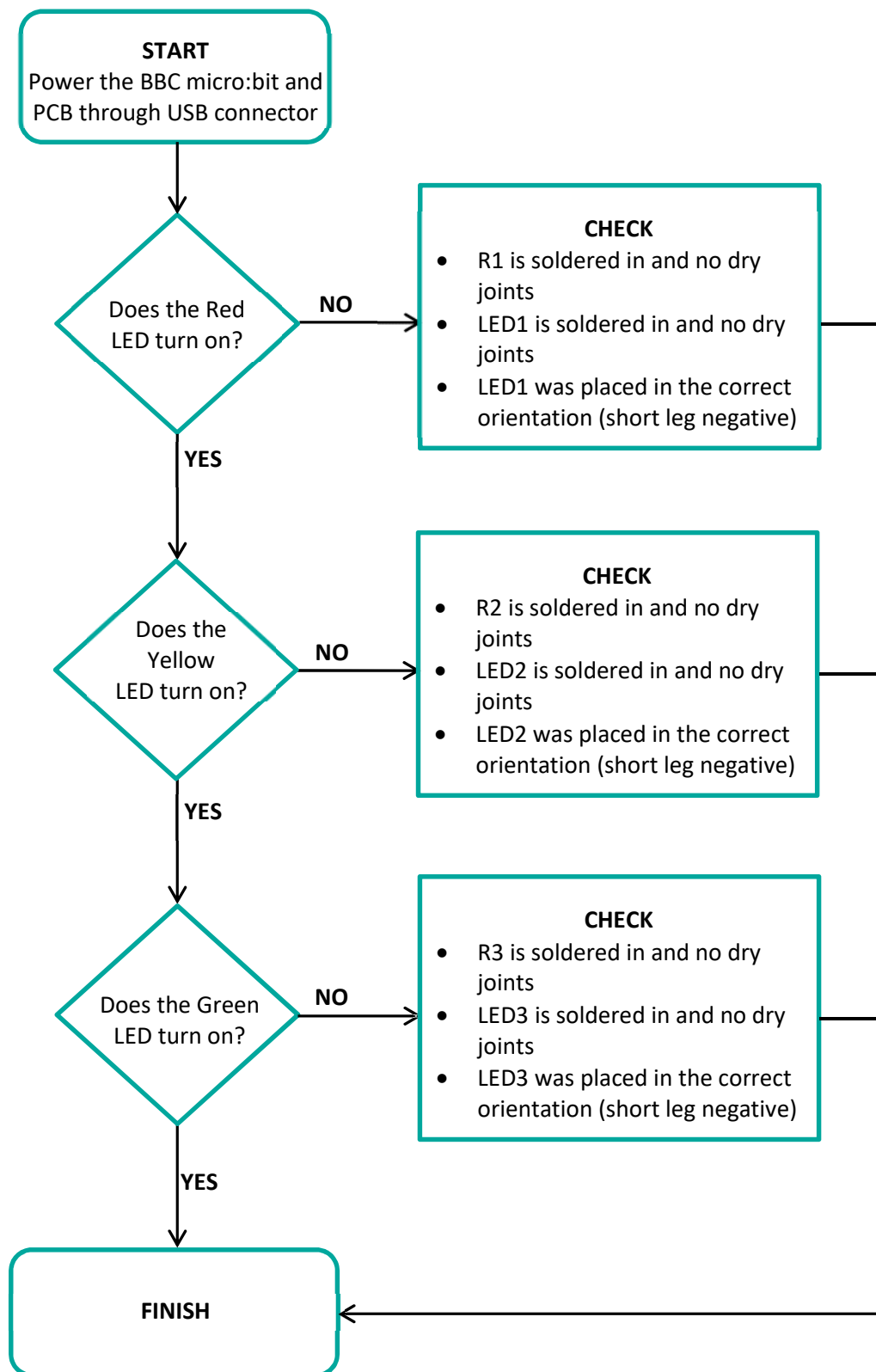

How the Circuit Works

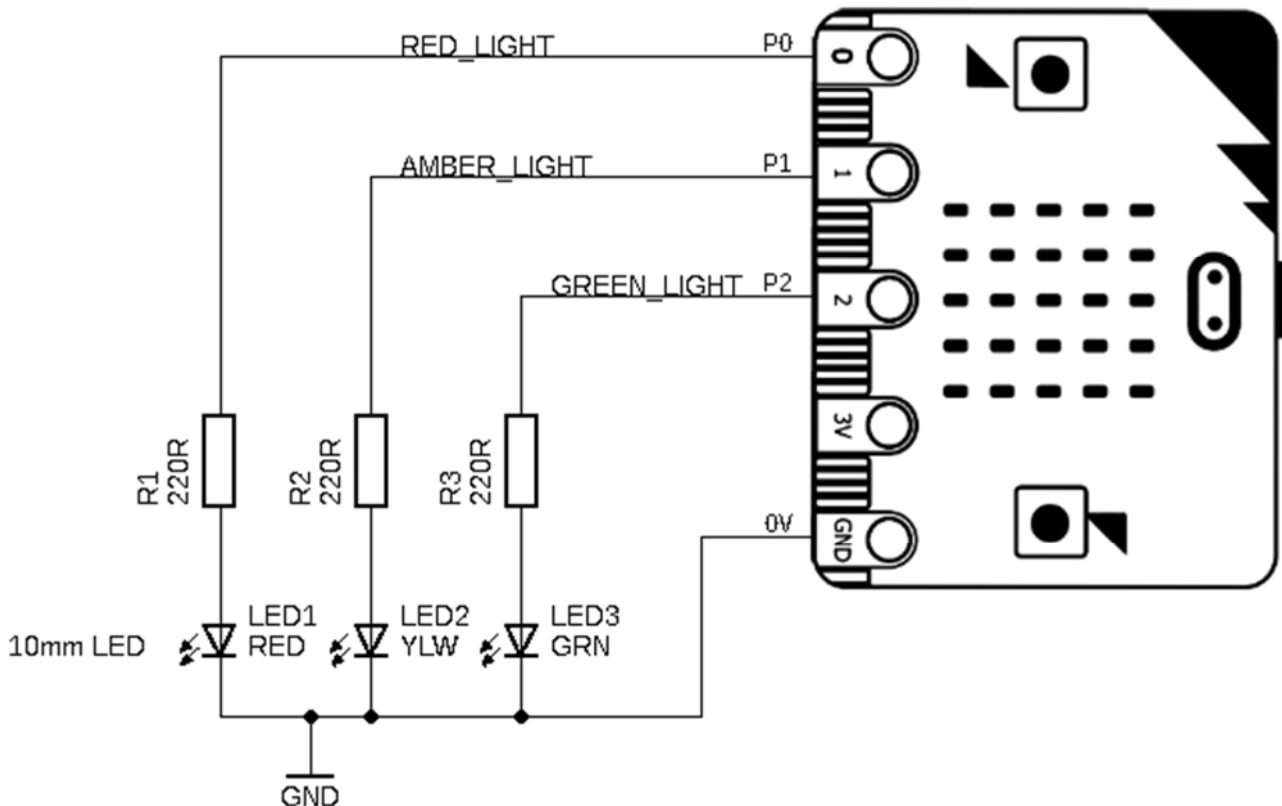

The circuit on the STOP:bit PCB itself is very simple, just three LED and current limiting resistor pairs, with each pair connected to one of the BBC micro:bit pins (Red LED1 to Pin 0, Yellow LED2 to Pin 1, Green LED3 to Pin 2). The cathodes of each LED are connected together and then connected to the BBC micro:bit 'GND' pin, completing the circuit setup. Power is provided via the USB connector on the BBC micro:bit, with an on-board voltage regulator producing the required 3.3V. By itself, this circuit will not cause the LEDs to light up, even if power is present; software needs to be written to enable control of each LED.

For the purposes of this circuit, Pins 0, 1 and 2 on the BBC micro:bit are configured as digital outputs. This means that they can be set to produce either a 'High' signal or a 'Low' signal. In digital electronics and programming, a 'High' signal is often specified by a '1', and a 'Low' signal as a '0'. This can be seen in the Microsoft MakeCode programming environment used to write software for the BBC micro:bit. Under the 'Pins' section, blocks can be found to read and write digital signals; an example is shown below:

```
on button A pressed
  digital write pin P0 to 1
  pause (ms) 1000
  digital write pin P0 to 0
```

In this simple program, pressing Button A on the BBC micro:bit will set the output of Pin 0 to be 'High' for 1000ms (1 second), and then set it back to 'Low'.

If the BBC micro:bit with this program were to be connected to the STOP:bit as shown in the circuit diagram above and Button A was pressed, this would cause the Red LED to turn on for 1 second before turning off again.

Why does this happen?



STOP:bit Kit Essentials

www.kitronik.co.uk/5642K



Digital 'High' and 'Low' signals ('1' and '0') are just representations of what is happening electrically, in reality, these signals are actual voltages. For the BBC micro:bit, because it is running at 3.3V with a USB cable plugged in, a digital 'High' signal is a 3.3V output, and a digital 'Low' signal is a 0V output.

As has already been covered in the 'LEDs & Current Limit Resistors' section, for an LED to light up it needs to have an appropriate current running through it, and for this to happen, there needs to be a voltage drop – or voltage difference – across it. In this circuit setup, the cathode of each LED is always connected to GND (0V), so a positive voltage needs to be applied to the anode (through the current limit resistor) in order to turn it on. This happens any time Pin 0, 1 or 2 is set to 'High', there is a voltage difference across the LED, so current flows, and the LED light up. In a similar way, any time Pin 0, 1 or 2 is set to 'Low', there is no voltage difference across the LED, so no current flows, and the LED turns off.

This is what is happening in the 'kitronik-stopbit' MakeCode extension blocks, different options will set the outputs of Pins 0, 1 and 2 to be 'High' or 'Low' in different configurations, thereby switching different LEDs on and off.



Online Information

Two sets of information can be downloaded from the product page where the kit can also be reordered from. The 'Essential Information' contains all of the information that you need to get started with the kit and the 'Teaching Resources' contains more information on soldering, components used in the kit, educational schemes of work and so on and also includes the essentials. Download from:

www.kitronik.co.uk/5642K



This kit is designed and manufactured in the UK by Kitronik

Telephone: +44 (0) 845 8380781

Sales email: sales@kitronik.co.uk

Tech support email: support@kitronik.co.uk

Web: www.kitronik.co.uk



www.kitronik.co.uk/twitter



www.kitronik.co.uk/facebook



www.kitronik.co.uk/youtube



www.kitronik.co.uk/google

Every effort has been made to ensure that these notes are correct, however Kitronik accept no responsibility for issues arising from errors / omissions in the notes.

© Kitronik Ltd - Any unauthorised copying / duplication of this booklet or part thereof for purposes except for use with Kitronik project kits is not allowed without Kitronik's prior consent.

