

Power Amplifier, 4 W 13.5 - 15.0 GHz



MAAP-011313

Rev. V1

Features

- High Gain: 36 dB
- P1dB: 34.5 dBm
- P3dB: 36.0 dBm
- IM3 Level: -28 dBc @ P_{OUT} = 28 dBm/tone
- Power Added Efficiency: 28% @ P3dB
- Temperature Compensated Output Power Detector
- Lead-Free 5 mm AQFN 32-lead Package
- RoHS* Compliant

Applications

- VSAT

Description

The MAAP-011313 is a 4 W, 4-stage power amplifier assembled in a lead-free 5 mm 32-lead air cavity QFN plastic package. This power amplifier operates from 13.5 to 15 GHz and provides 35 dB of linear gain, 4 W saturated output power and 28% efficiency while biased at 6 V.

The MAAP-011313 can be used as a power amplifier stage or as a driver stage in higher power applications. This device is ideally suited for linear Ku-band VSAT communications.

This product is fabricated using a GaAs pHEMT process which features full passivation for enhanced reliability.

Ordering Information^{1,2}

Part Number	Package
MAAP-011313	bulk part
MAAP-011313-TR0500	500 part reel
MAAP-011313-001SMB	sample board

1. Reference Application Note M513 for reel size information.
2. All sample boards include 3 loose parts.

Functional Schematic

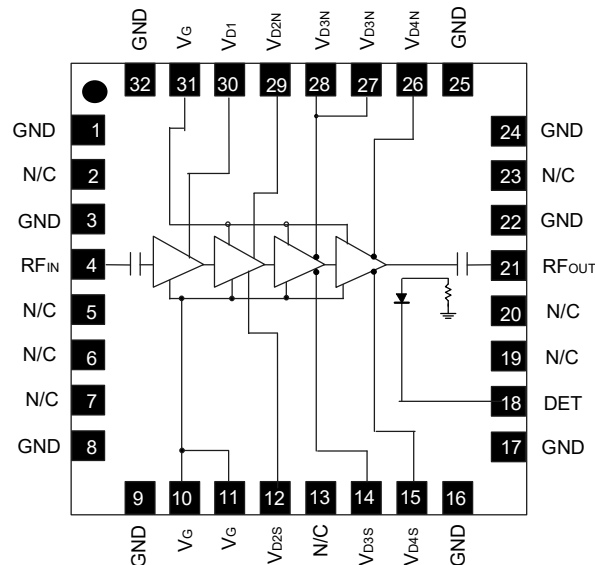

Pin Configuration^{3,4}

Pin #	Pin Name	Description
1, 3, 8, 9, 16, 17, 22, 24, 25, 32	GND	Ground
2, 5, 6, 7, 13, 19, 20, 23	N/C	No Connection
4	RF _{IN}	RF Input
10, 11, 31	V _G	Gate Voltage
12	V _{D2S}	Drain 2 South Voltage
14	V _{D3S}	Drain 3 South Voltage
15	V _{D4S}	Drain 4 South Voltage
18	DET	Power Detector
21	RF _{OUT}	RF Output
26	V _{D4N}	Drain 4 North Voltage
27, 28	V _{D3N}	Drain 3 North Voltage
29	V _{D2N}	Drain 2 North Voltage
30	V _{D1}	Drain 1 Voltage

3. MACOM recommends connecting all No Connection (N/C) pins to ground.
4. The exposed pad centered on the package bottom must be connected to RF, DC and thermal ground.

* Restrictions on Hazardous Substances, compliant to current RoHS EU directive.

Power Amplifier, 4 W

13.5 - 15.0 GHz



MAAP-011313

Rev. V1

Electrical Specifications: $T_A = +25^\circ\text{C}$, $V_D = 6\text{ V}$, $Z_0 = 50\ \Omega$

Parameter	Test Conditions	Units	Min.	Typ.	Max.
Gain	13.5 GHz 15 GHz	dB	34	36	—
Gain Flatness	within 14 - 14.5 GHz band any 20 MHz channel	dB	—	0.1	—
Output Power	P1dB	dBm	—	34.5	—
Output Power (@ $P_{IN} = 3\text{ dBm}$)	P3dB, 13.5 GHz	dBm	34.5	36	—
IM3 Level	$P_{OUT} = 28\text{ dBm/tone}$, $\Delta F = 10\text{ MHz}$	dBc	—	-28	—
Power Added Efficiency	P3dB	%	—	28	—
Input Return Loss	—	dB	—	15	—
Output Return Loss	—	dB	—	15	—
Quiescent Current	I_{DSQ} (see bias conditions, page 4)	mA	—	1600	—
Drain Current ($V_{D1} + V_{D2} + V_{D3} + V_{D4}$)	P3dB	mA	—	3000	—

Maximum Operating Conditions

Parameter	Rating
Input Power	$P_{IN} \leq 3\text{ dB Compression}$
Junction Temperature ^{5,6}	+160°C
Operating Temperature	-40°C to +85°C

- Operating at nominal conditions with junction temperature $\leq +160^\circ\text{C}$ will ensure $MTTF > 1 \times 10^6$ hours.
- Junction Temperature (T_J) = $T_C + \Theta_{JC} * ((V * I) - (P_{OUT} - P_{IN})) = 85 + 4.56 * (6 * 2.82 - (5 - 0.004)) = 139.4^\circ\text{C}$
- Typical thermal resistance (Θ_{JC}) = 4.56 °C/W.

Handling Procedures

Please observe the following precautions to avoid damage:

Static Sensitivity

These electronic devices are sensitive to electrostatic discharge (ESD) and can be damaged by static electricity. Proper ESD control techniques should be used when handling these HBM Class 1A devices.

Absolute Maximum Ratings^{8,9}

Parameter	Absolute Maximum
Input Power	23 dBm
Drain Voltage	+6.5 V
Gate Voltage	-3 to 0 V
Junction Temperature ¹⁰	+175°C
Storage Temperature	-65°C to +125°C

- Exceeding any one or combination of these limits may cause permanent damage to this device.
- MACOM does not recommend sustained operation near these survivability limits.
- Junction temperature directly affects device MTTF. Junction temperature should be kept as low as possible to maximize lifetime.

Sample Board Layout

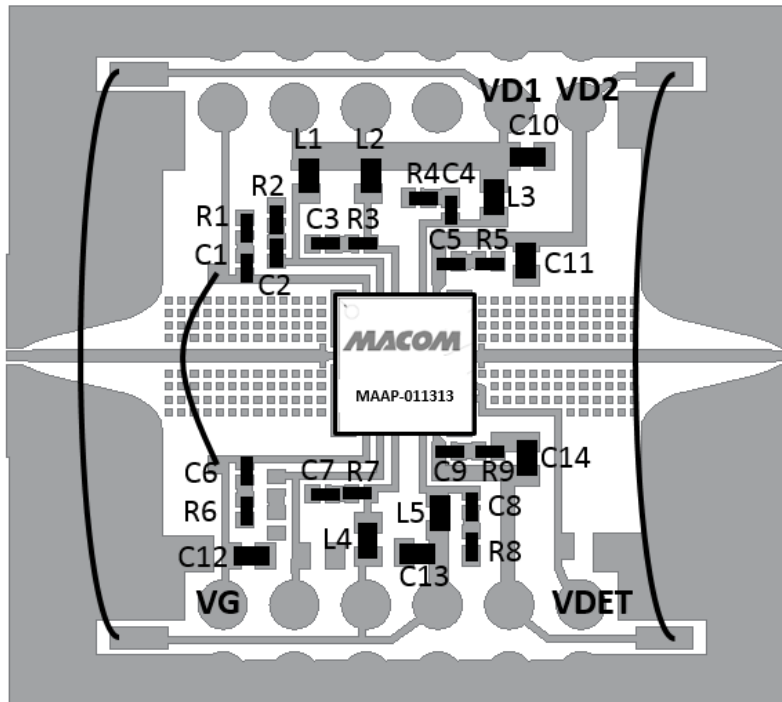

Application Schematic

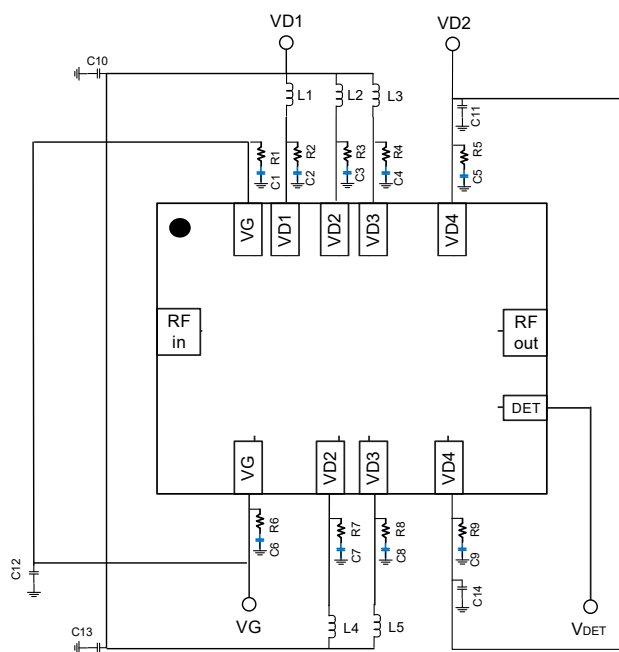

Parts List

Part	Value	Case Style
C1 - C9	0.01 μ F	0402
C10 - C14	22 μ F	0603
R1 - R9	10 Ω	0402
L1 - L5	Ferrite bead Murata BLM18HE601SN1D	0603

Sample Board Material Specifications

Top Layer: 1/2 oz Copper Cladding, 0.017 mm thickness
Dielectric Layer: Rogers RO4003C 0.203 mm thickness
Bottom Layer: 1/2 oz Copper Cladding, 0.017 mm thickness
Finished overall thickness: 0.238 mm

Recommended PCB Layout Detail:

RF input and output pre-matching circuit patterns are identical and are designed to compensate packaging effects. Transmission line dimensions apply to a PCB with 0.203 mm thick Rogers RO4003C laminate dielectric. Performance curves shown in this data sheet were measured with these circuit patterns.

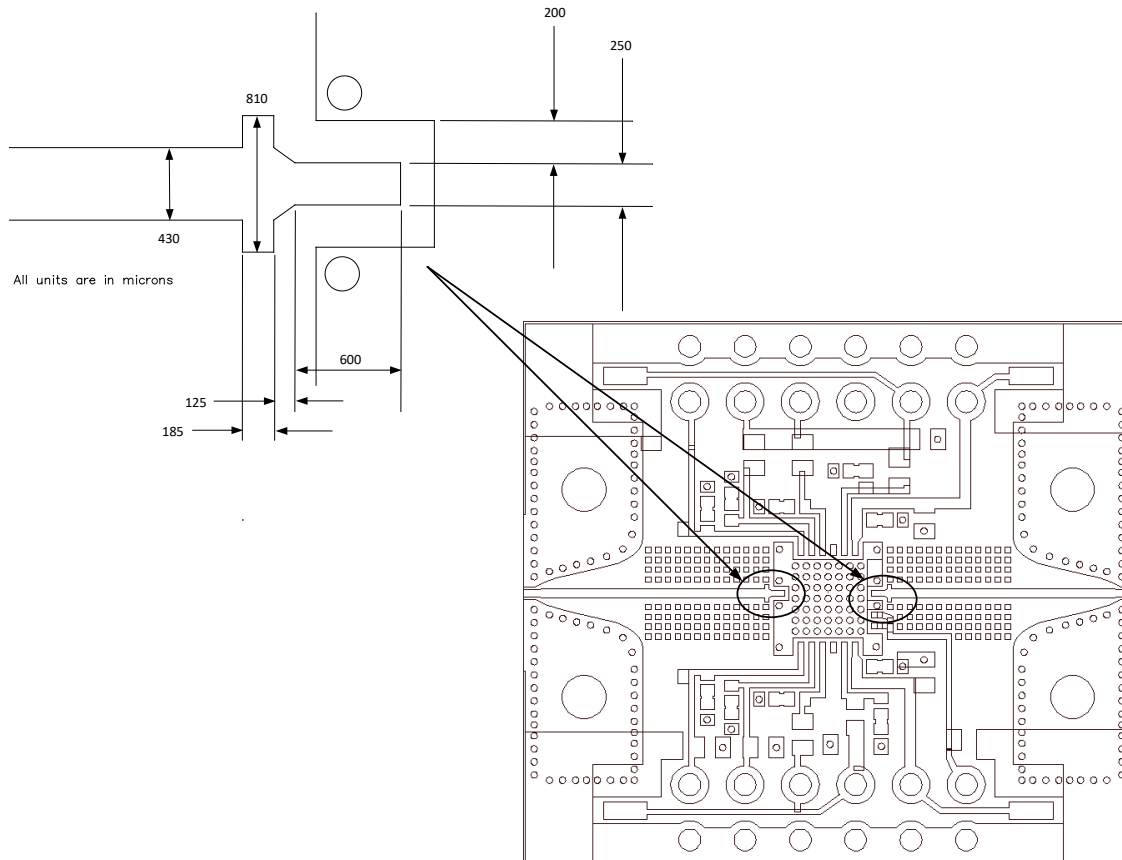

Biasing Conditions

Recommended biasing conditions are $V_D = 6\text{ V}$, $I_{DSQ} = 1.6\text{ A}$ (controlled with V_G). The drain bias voltage range is 4 to 6 V and the quiescent drain current biasing range is 1.5 to 2.2 A.

V_G pins 10 and 11 are connected internally and only one pin is required for biasing. Pin 31 is not connected internally; an external connection to pin 10 or 11 is required. Muting can be accomplished by setting the V_G to the pinched off voltage ($V_G = -2\text{ V}$).

V_D bias must be applied to all VDX pins (V_{D1} , V_{D2} , V_{D3} and V_{D4}) on both sides of the device as these pins are not internally connected.

Operating the MAAP-011313

Turn-on

1. Apply V_G (-1.5 V).
2. Apply V_D (6.0 V typical).
3. Set I_{DQ} by adjusting V_G more positive (typically -0.9 to -1.0 V for $I_{DSQ} = 1.6\text{ A}$).
4. Apply RF_{IN} signal.

Turn-off

1. Remove RF_{IN} signal.
2. Decrease V_G to -1.5 V.
3. Decrease V_D to 0 V.

Typical Performance Curves: $V_D = 6\text{ V}$, $I_{DSQ} = 1600\text{ mA}$

Small Signal Gain vs. Frequency over Temperature

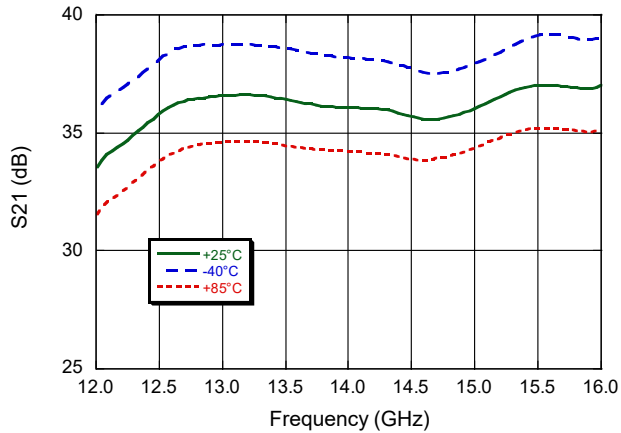

Small Signal Gain vs. Frequency over Bias Voltage

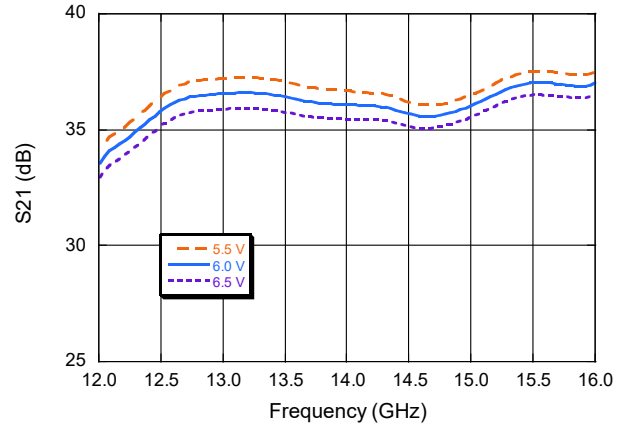

Input Return Loss vs. Frequency over Temperature

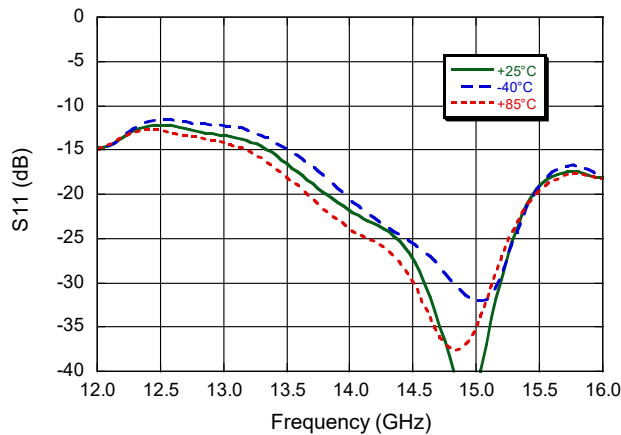

Input Return Loss vs. Frequency over Bias Voltage

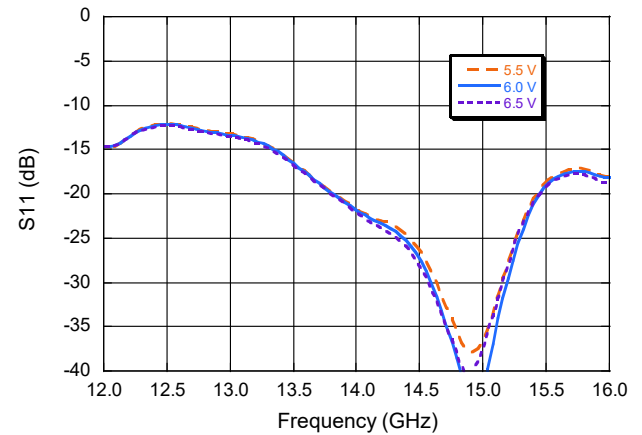

Output Return Loss vs. Frequency over Temperature

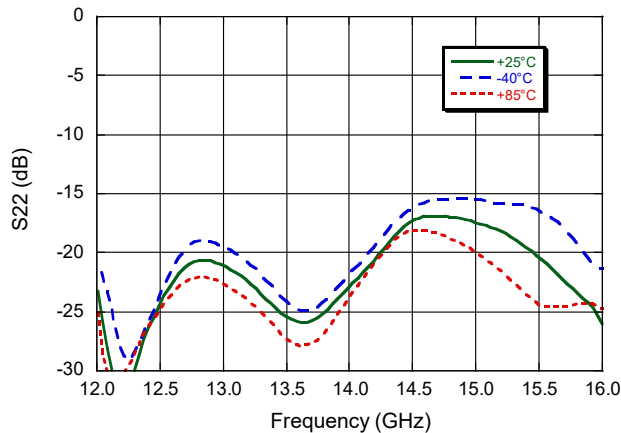

Output Return Loss vs. Frequency over Bias Voltage

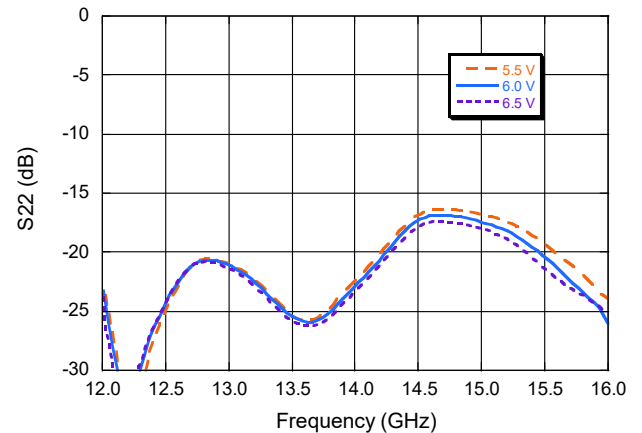

Power Amplifier, 4 W 13.5 - 15.0 GHz



MAAP-011313

Rev. V1

Typical Performance Curves: $V_D = 6\text{ V}$, $I_{DSQ} = 1600\text{ mA}$

P3dB vs. Frequency over Temperature

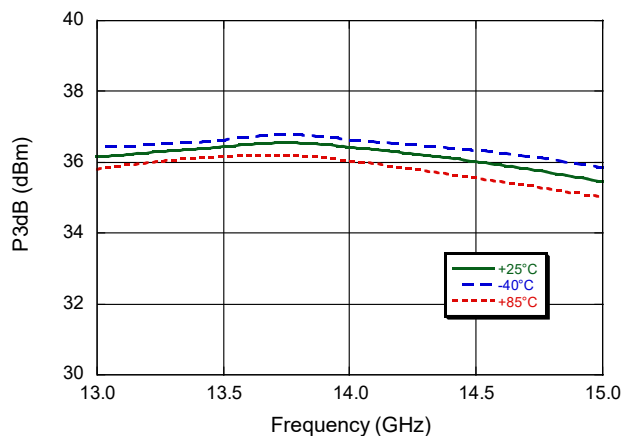

P3dB vs. Frequency over Bias Voltage

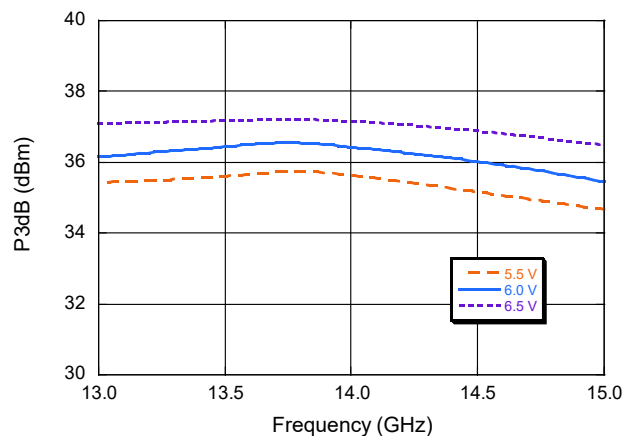

P1dB vs. Frequency over Temperature

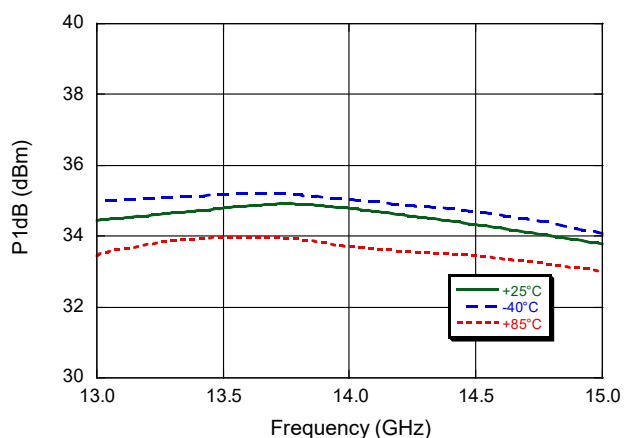

P1dB vs. Frequency over Bias Voltage

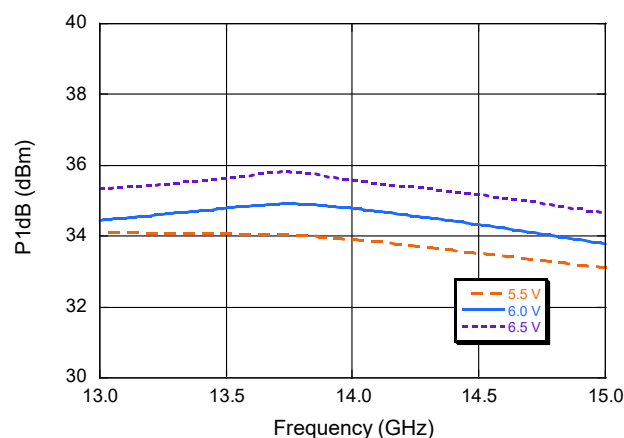

Typical Performance Curves: $V_D = 6\text{ V}$, $I_{DSQ} = 1600\text{ mA}$

IM3 vs. Output Power (13.75 GHz)

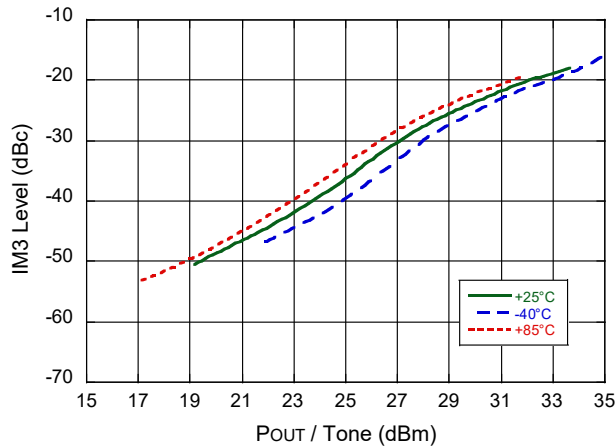

IM3 vs. Output Power @ 25°C

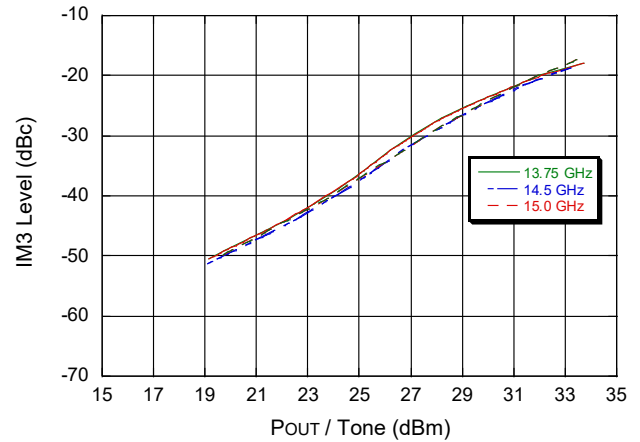

IM3 vs. Output Power (14.5 GHz)

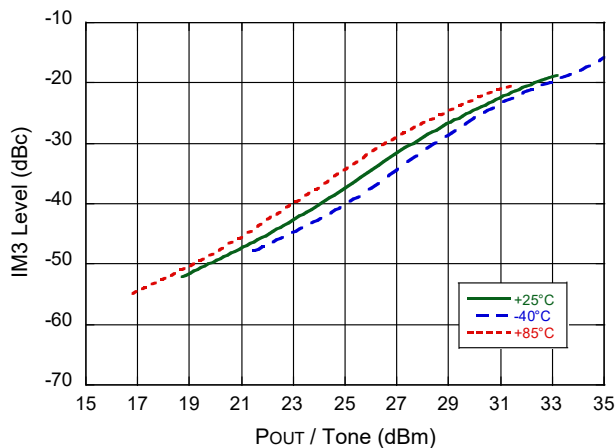

IM3 vs. Frequency @ Output Power = 28 dBm/tone

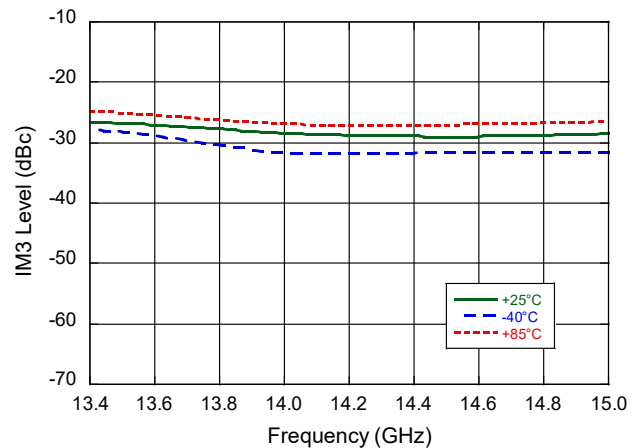

IM3 vs. Output Power (15 GHz)

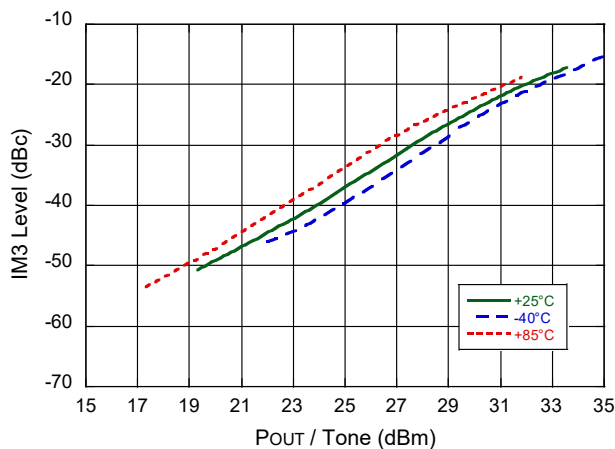

Output IP3 vs. Output Power

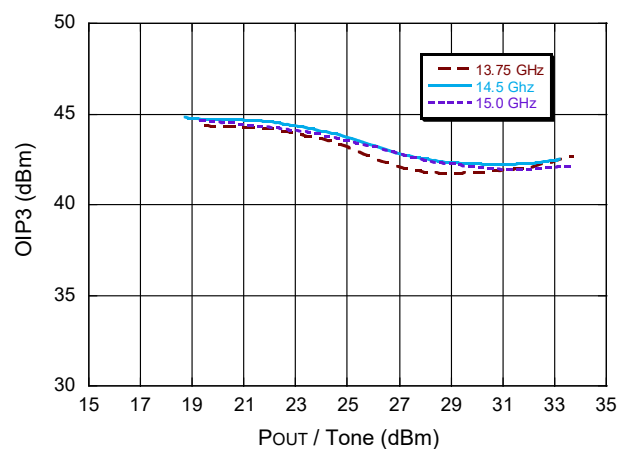

Typical Performance Curves: $V_D = 6\text{ V}$, 25°C

IM3 vs. Output Power by Drain Current @ 13.75 GHz

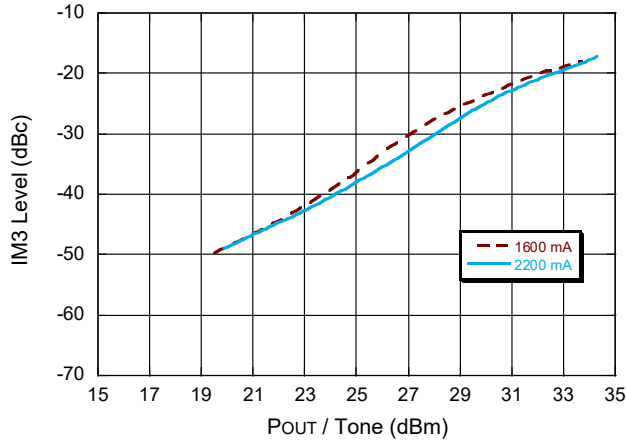

IM3 vs. Frequency by Drain Current @ Output Power = 28 dBm/tone

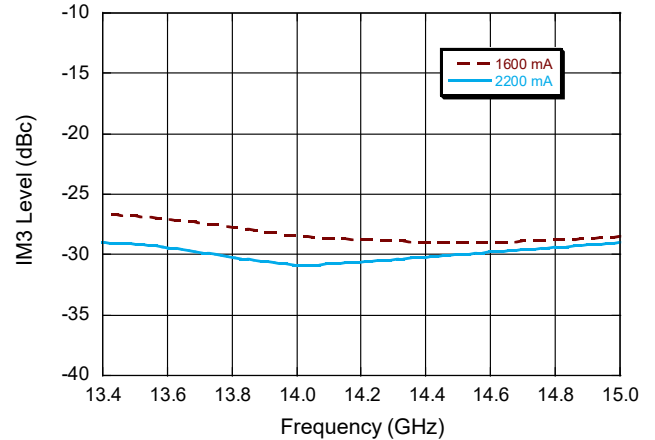

IM3 vs. Output Power by Drain Current @ 14.5 GHz

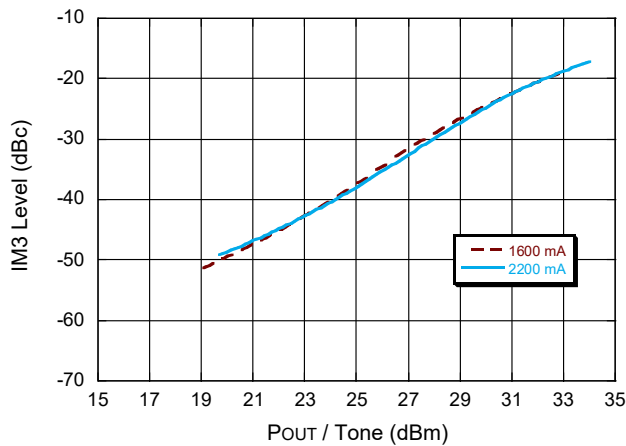

Output IP3 vs. Output Power @ 14.5 GHz

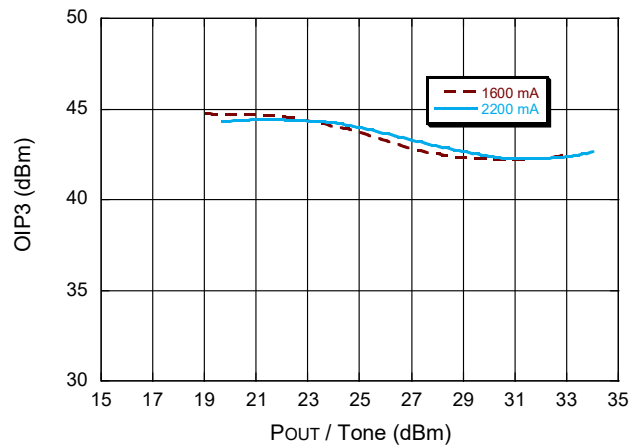

IM3 vs. Output Power by Drain Current @ 15 GHz

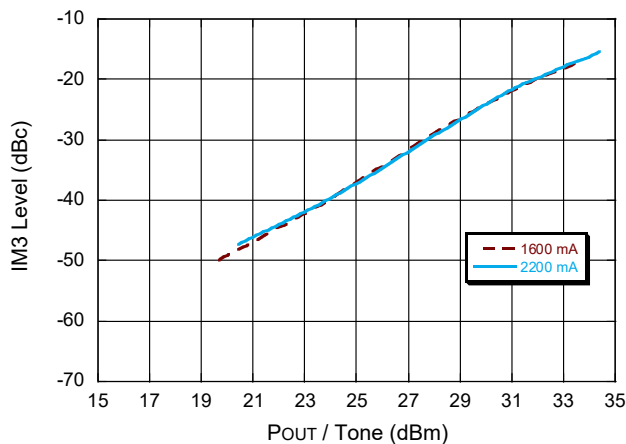

Sample Board Thru Loss

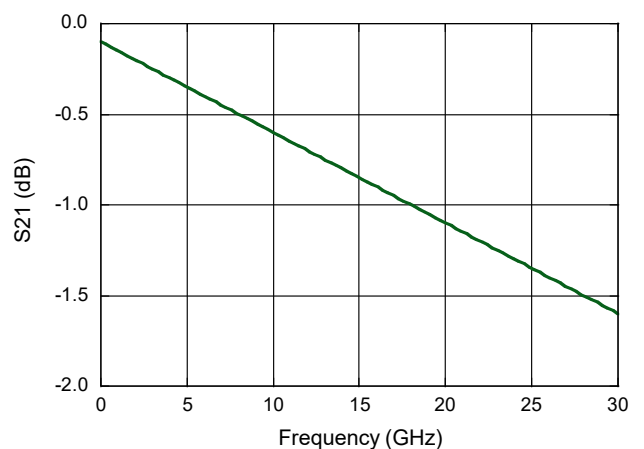

Power Amplifier, 4 W 13.5 - 15.0 GHz



MAAP-011313

Rev. V1

Typical Performance Curves: $V_D = 6\text{ V}$, $I_{DSQ} = 1600\text{ mA}$, 25°C

Output Power vs. Input Power

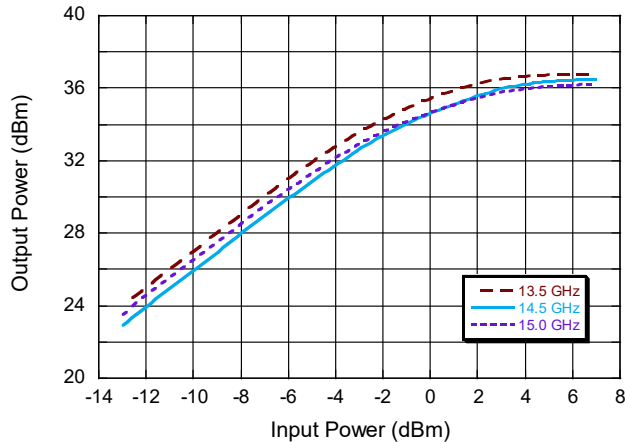

Gain and PAE @ P3dB vs. Frequency

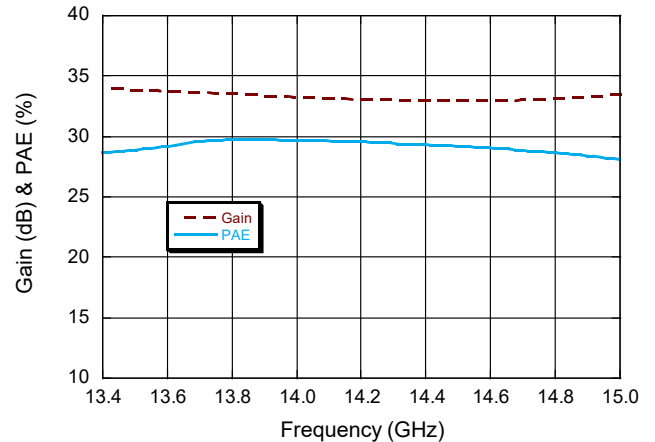

Bias Current vs. Input Power

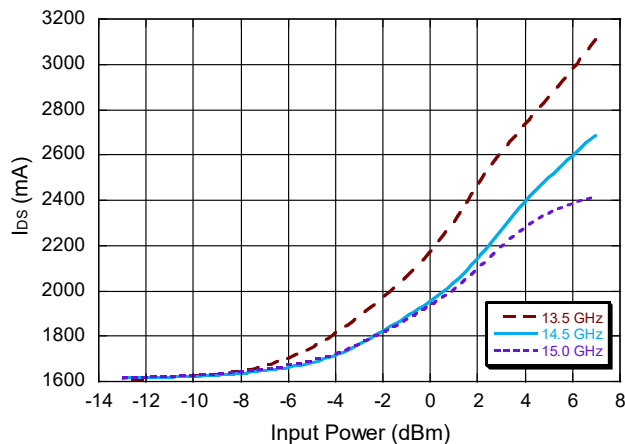

PAE vs. Input Power

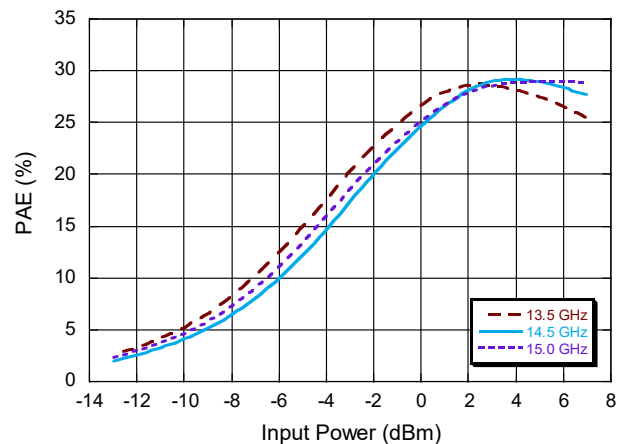

Gate Current @ P3dB

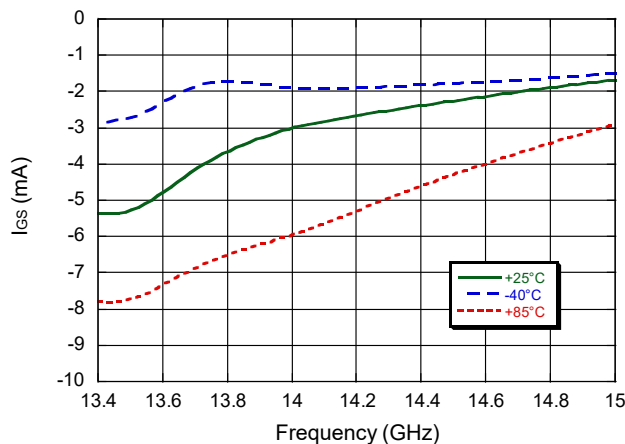

Detector Voltage vs. Output Power @ 14 GHz

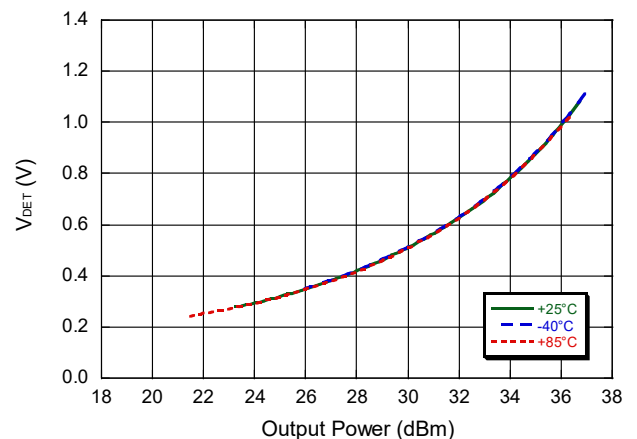

Power Amplifier, 4 W 13.5 - 15.0 GHz



MAAP-011313

Rev. V1

Lead-Free 5 mm 32-Lead AQFN Package[†]

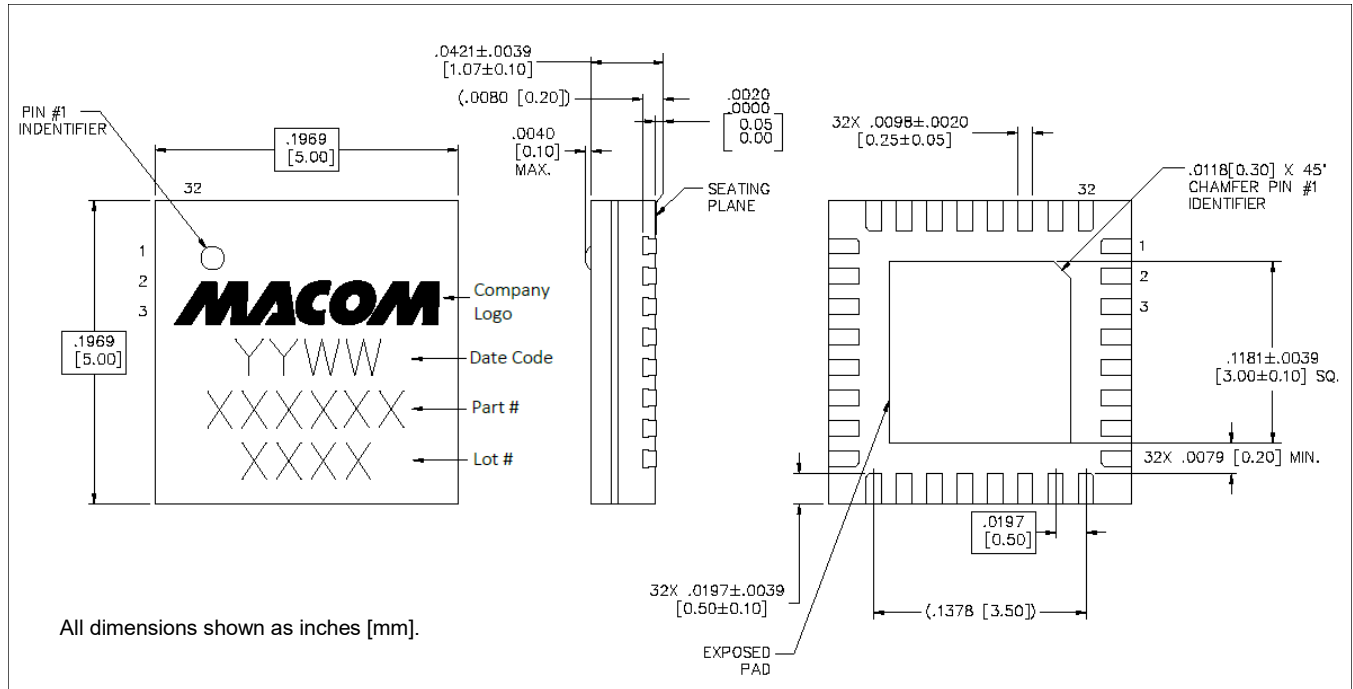

[†] Reference Application Note S2083 for lead-free solder reflow recommendations.
Meets JEDEC moisture sensitivity level 3 requirements.
Plating is NiPdAu.

MACOM Technology Solutions Inc. ("MACOM"). All rights reserved.

These materials are provided in connection with MACOM's products as a service to its customers and may be used for informational purposes only. Except as provided in its Terms and Conditions of Sale or any separate agreement, MACOM assumes no liability or responsibility whatsoever, including for (i) errors or omissions in these materials; (ii) failure to update these materials; or (iii) conflicts or incompatibilities arising from future changes to specifications and product descriptions, which MACOM may make at any time, without notice. These materials grant no license, express or implied, to any intellectual property rights.

THESE MATERIALS ARE PROVIDED "AS IS" WITH NO WARRANTY OR LIABILITY, EXPRESS OR IMPLIED, RELATING TO SALE AND/OR USE OF MACOM PRODUCTS INCLUDING FITNESS FOR A PARTICULAR PURPOSE, MERCHANTABILITY, INFRINGEMENT OF INTELLECTUAL PROPERTY RIGHT, ACCURACY OR COMPLETENESS, OR SPECIAL, INDIRECT, INCIDENTAL, OR CONSEQUENTIAL DAMAGES WHICH MAY RESULT FROM USE OF THESE MATERIALS.

MACOM products are not intended for use in medical, lifesaving or life sustaining applications. MACOM customers using or selling MACOM products for use in such applications do so at their own risk and agree to fully indemnify MACOM for any damages resulting from such improper use or sale.