

WHITE CODING
0988211030

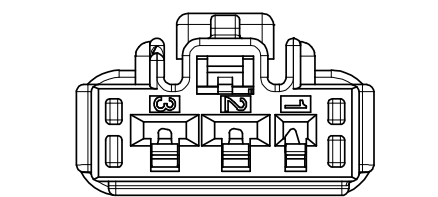

BLACK CODING
0988211031

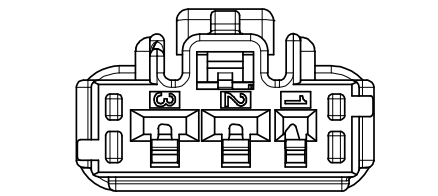

GREEN CODING
0988211035

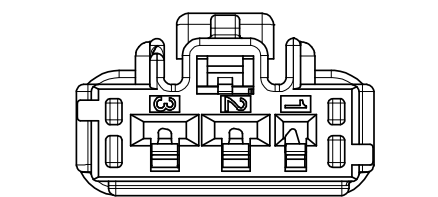

BROWN CODING
0988211039

CODING 4:1

HANDLING AREA

AREA REQUIRED TO MATE
AND UNMATE THE CONNECTOR

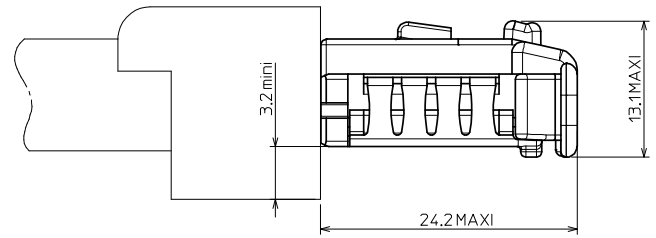
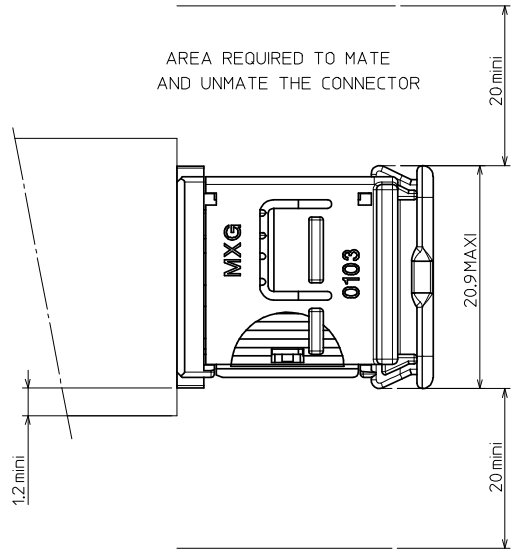

NOTE : 1 - The using conditions of the hinge are shown in the MOLEX specification n°AS-98821-001.

2 - Female terminal used :

* For cavity 1.5 mm : SCC RCPT TERM 1.5mm

- Range 1 : 0988971109 (0.22 mm² to 2x0.22 mm²)
- Range 2 : 0988971119 (0.5 mm² to 1 mm² included)
- Range 3 : 0988971129 (2x0.5 mm² to 2 mm² included)

* for cavity 2.8 mm : RCPT TERM 2.8 mm UCC2

- Range 1 : 0988981029 (0.34 mm² to 0.68 mm²)
- Range 2 : 0988981039 (0.93 mm² to 2.16 mm²)
- Range 3 : 0988981049 (2.26 mm² to 4.95 mm²)

AREA REQUIRED WHEN THE CONNECTOR IS MATED

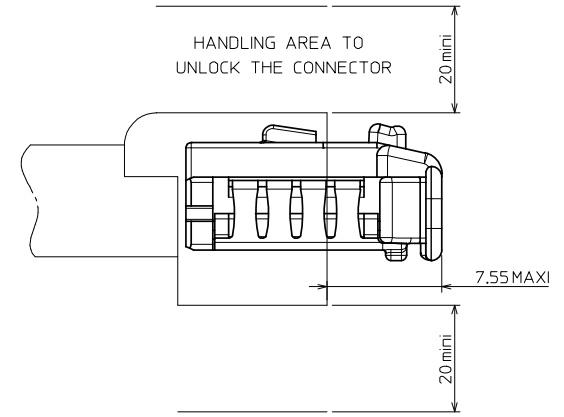

FIRST RELEASE EC NO: G2009-0009 DRAWN: LPOUCHAUD 2008/07/28 CHKD: YIGEL 2008/07/28 APPR: LSTICKEIR 2008/07/29	DESCRIPTION NCS HYBRID RCPT CONN 3CKT	GENERAL TOLERANCES (UNLESS SPECIFIED)		DIMENSION STYLE MM ONLY	SCALE 3:1	DESIGN UNITS METRIC	THIRD ANGLE PROJECTION	
		4 PLACES ± --- ± ---	mm INCH	DRAWN BY LPOUCHAUD	DATE 2008/06/18	TITLE NSSC HYBRID RCPT CONN 3CKT		
		3 PLACES ± --- ± ---		CHECKED BY YIGEL	DATE 2008/06/18	MOLEX INCORPORATED		
		2 PLACES ± --- ± ---		APPROVED BY LSTICKEIR	DATE 2008/06/18	DOCUMENT NO. SD-98821-001	SHEET NO. 1 OF 2	
1 PLACE ± 0.10 ± ---	ANGULAR ± 2 °	DRAFT WHERE APPLICABLE MUST REMAIN WITHIN DIMENSIONS		SEE CHART			THIS DRAWING CONTAINS INFORMATION THAT IS PROPRIETARY TO MOLEX INCORPORATED AND SHOULD NOT BE USED WITHOUT WRITTEN PERMISSION	

DATUM MONTH/YEAR

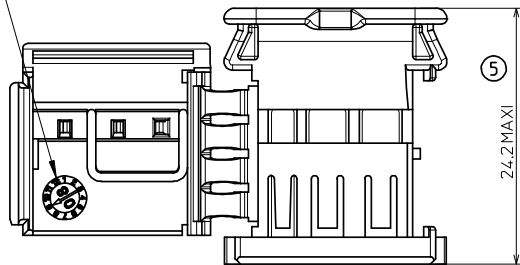

5

24.2 MAXI

CAVITY NUMBER

CAVITY NUMBER

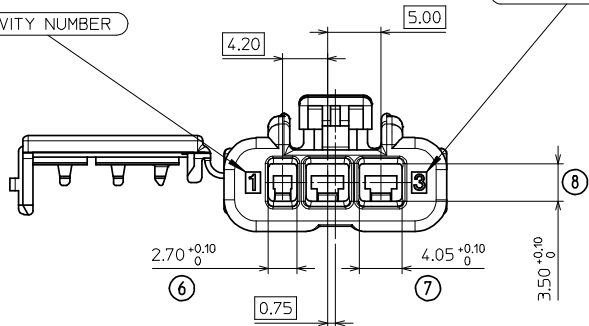

2.70 +0.10/0

6

4.20

0.75

4.05 +0.10/0

7

3.50 +0.10/0

8

5.00

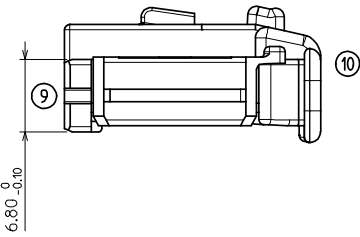

6.80 0/-0.10

9



1:1

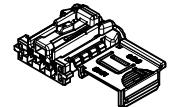
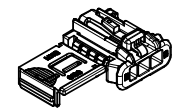
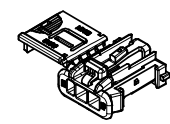
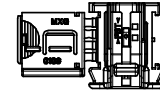

1:1

CAVITY NUMBER

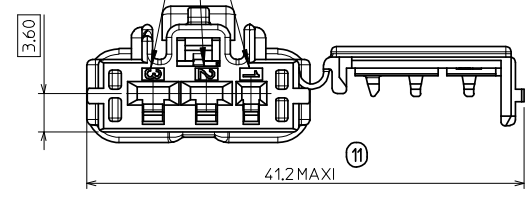

3.60

41.2 MAXI

11

SUPPLIER ENGINEERING CONTROL

RAW MATERIAL

PRINT NUMBER

SUPPLIER MODIFICATION LEVEL

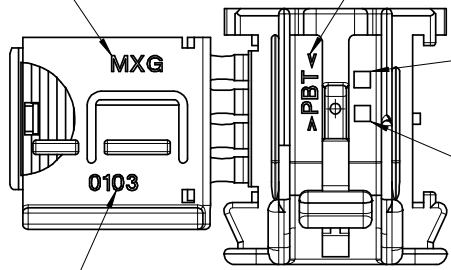

MXG

0103

PRINT

SUPPLIER PART NUMBER

WHITE CODING (P/N 0988211030) IS SHOWN.

NSCC HYBRID RCPT CONN 3CKT	0988211039	Brown	POLYESTER (PBT)	2.694 g				
	0988211035	Green						
	0988211031	Black						
	0988211030	White						
Description	Part-Number	Color	Raw Material	Weight effective				
EC NO: G2009-0009 DRAWN: LPOUCHAUD 2008/07/28 CHKD: YIGEL 2008/07/28 APPR: LSTICKEIR 2008/07/29	QUALITY SYMBOLS ▽=0 ▽=0	GENERAL TOLERANCES (UNLESS SPECIFIED)		DIMENSION STYLE	SCALE	DESIGN UNITS	THIRD ANGLE PROJECTION	
		4 PLACES ± --- ± --- 3 PLACES ± --- ± --- 2 PLACES ± --- ± --- 1 PLACE ± 0.10 ± --- ANGULAR ± 2 °	mm INCH DRAWN BY DATE LPOUCHAUD 2008/06/18 CHECKED BY DATE YIGEL 2008/06/18 APPROVED BY DATE LSTICKEIR 2008/06/18 MATERIAL NO.	MM ONLY	3:1	METRIC		TITLE
DRAFT WHERE APPLICABLE MUST REMAIN WITHIN DIMENSIONS		SEE CHART		NSCC HYBRID RCPT CONN 3CKT			MOLEX INCORPORATED SD-98821-001	SHEET NO. 2 OF 2
FIRST RELEASE		THIS DRAWING CONTAINS INFORMATION THAT IS PROPRIETARY TO MOLEX INCORPORATED AND SHOULD NOT BE USED WITHOUT WRITTEN PERMISSION						