

Data sheet | Item number: 2250-1207

2-conductor miniature ground terminal block; with push-button; 1 mm²; side and center marking; for DIN-15 rail; Push-in CAGE CLAMP®; 1,00 mm²; green-yellow

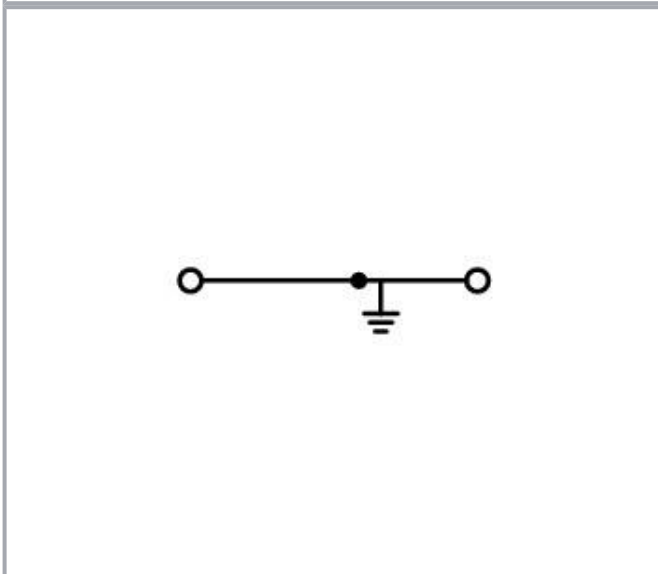

www.wago.com/2250-1207

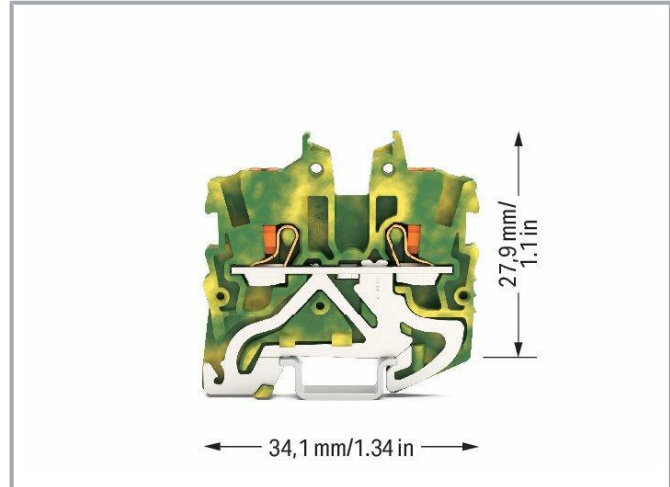

Subject to changes. Please also observe the further product documentation!

WAGO GmbH & Co. KG
Hansastr. 27
32423 Minden
Phone: +49571 887-0 | Fax: +49571 887-169
Email: info.de@wago.com | Web: www.wago.com

Do you have any questions about our products?
We are always happy to take your call at +49 (571) 887-44222.



Data

Electrical data

Ratings per IEC/EN

Ratings per	IEC/EN 60947-7-2
-------------	------------------

Ex information

Reference hazardous areas	See "Downloads – Documentation – Additional Information: Technical Section; Technical Explications"
---------------------------	---

Connection data

Connection points	2
Total number of potentials	1
Number of levels	1
Number of jumper slots	1

Connection 1

Connection technology	Push-in CAGE CLAMP®
Actuation type	Push-button
Connectable conductor materials	Copper
Nominal cross-section	1 mm ²
Solid conductor	0.14 ... 1.5 mm ² / 24 ... 16 AWG
Solid conductor; push-in termination	0.5 ... 1.5 mm ² / 20 ... 16 AWG
Fine-stranded conductor	0.14 ... 1.5 mm ² / 24 ... 16 AWG
Fine-stranded conductor; with insulated ferrule	0.14 ... 0.75 mm ² / 24 ... 18 AWG
Fine-stranded conductor; with ferrule; push-in termination	0.5 ... 0.75 mm ² / 20 ... 18 AWG
Note (conductor cross-section)	Depending on the conductor characteristic, a conductor with a smaller cross-section can also be inserted via push-in termination.
Strip length	9 ... 11 mm / 0.35 ... 0.43 inches
Wiring direction	Front-entry wiring

Physical data

Width	3.5 mm / 0.138 inches
Height	34.1 mm / 1.343 inches
Depth from upper-edge of DIN-rail	27.9 mm / 1.098 inches

Subject to changes. Please also observe the further product documentation!



Mechanical Data

Mounting type	DIN-15 rail
Marking level	Center/side marking

Material Data

Note (material data)	Information on material specifications can be found here
Color	green-yellow
Material group	I
Insulation material	Polyamide (PA66)
Flammability class per UL94	V0
Fire load	0.065 MJ
Weight	3.8 g

Environmental requirements

Processing temperature	-35 ... +85 °C
Continuous operating temperature	-60 ... +105 °C

Commercial data

ETIM 8.0	EC000901
ETIM 7.0	EC000901
PU (SPU)	100 pcs
Country of origin	DE
GTIN	4055143981729
Customs tariff number	85369010000

Environmental Product Compliance

RoHS Compliance Status	Compliant, No Exemption
------------------------	-------------------------

Approvals / Certificates

General approvals

Logo	Approval	Additional Approval Text	Certificate name
	CCA DEKRA Certification B.V.	EN 60947	NTR NL 7839

Subject to changes. Please also observe the further product documentation!

CCA

CCA



cURus



CCA
DEKRA Certification B.V.

CSA
CSA

cURus
Underwriters Laboratories Inc.

KEMA/KEUR
DEKRA Certification B.V.

KEMA/KEUR
DEKRA Certification B.V.

EN 60998

C22.2 No. 158

UL 1059

EN 60998

EN 60947

NTR NL



7840

80034182

E45172

71-
11395771-
113930

Declarations of conformity and manufacturer's declarations

Logo	Approval	Additional Approval Text	Certificate name
	EU-Declaration of Conformity WAGO GmbH & Co. KG	-	-
	UK-Declaration of Conformity WAGO GmbH & Co. KG	-	-

Approvals for hazardous areas

Logo	Approval	Additional Approval Text	Certificate name
	AEx Underwriters Laboratories Inc.	UL 60079	E185892 (AEx eb IIC resp. Ex eb IIC)
	ATEX	EN IEC 60079-0	PTB 19 ATEX 1019

Subject to changes. Please also observe the further product documentation!

WAGO GmbH & Co. KG
Hansastr. 27
32423 Minden
Phone: +49571 887-0 | Fax: +49571 887-169
Email: info.de@wago.com | Web: www.wago.com

Do you have any questions about our products?
We are always happy to take your call at +49 (571) 887-44222.



Physikalisch Technische Bundesanstalt

U (II 2G Ex eb IIC Gb
or I M 2 Ex eb I Mb)



CCC
CNEX

GB/T 3836.3

2020312313000289
(Ex eb IIC Gb, Ex eb I Mb)



IECEX
Physikalisch Technische Bundesanstalt

IEC 60079

IECEX PTB 19.0050U
(Ex eb IIC Gb or EX eb I Mb)



INMETRO
TÜV Rheinland do Brasil Ltda.

IEC 60079

TÜV 22.0014 U

Required accessories

End plate

End plate



Item no.: 2050-1291
End and intermediate plate; 1.1 mm thick; gray

www.wago.com/2050-1291

Optional accessories

Marking accessories

Marking strip



Item no.: 2009-110
Marking strips; for Smart Printer; on reel; not stretchable; plain; snap-on type; white

www.wago.com/2009-110

Marker



Item no.: 2009-113
WMB-Inline; for Smart Printer; 2300 pieces on roll; plain; snap-on type; white

www.wago.com/2009-113



Item no.: 2009-113/000-002
WMB-Inline; for Smart Printer; 2300 pieces on roll; plain; snap-on type; yellow













www.wago.com/2009-113/000-002



Item no.: 2009-113/000-012
WMB-Inline; for Smart Printer; 2300 pieces on roll; plain; snap-on type; orange

www.wago.com/2009-113/000-012

Subject to changes. Please also observe the further product documentation!

	Item no.: 2009-113/000-007 WMB-Inline; for Smart Printer; 2300 pieces on roll; plain; snap-on type; gray	www.wago.com/2009-113/000-007
	Item no.: 2009-113/000-005 WMB-Inline; for Smart Printer; 2300 pieces on roll; plain; snap-on type; red	www.wago.com/2009-113/000-005
	Item no.: 2009-113/000-017 WMB-Inline; for Smart Printer; 2300 pieces on roll; plain; snap-on type; light green	www.wago.com/2009-113/000-017
	Item no.: 2009-113/000-006 WMB-Inline; for Smart Printer; 2300 pieces on roll; plain; snap-on type; blue	www.wago.com/2009-113/000-006
	Item no.: 2009-113/000-024 WMB-Inline; for Smart Printer; 2300 pieces on roll; plain; snap-on type; violet	www.wago.com/2009-113/000-024
	Item no.: 2009-113/000-023 WMB-Inline; for Smart Printer; 2300 pieces on roll; plain; snap-on type; green	www.wago.com/2009-113/000-023
	Item no.: 793-3501 WMB marking card; as card; plain; snap-on type; white	www.wago.com/793-3501
Group marker carrier		
	Item no.: 2009-191 Group marker carrier; gray	www.wago.com/2009-191
Tool		
Operating tool		
	Item no.: 210-648 Operating tool; Blade: 2.5 x 0.4 mm; with a partially insulated shaft; angled; short	www.wago.com/210-648
	Item no.: 210-647 Operating tool; Blade: 2.5 x 0.4 mm; with a partially insulated shaft; multicoloured	www.wago.com/210-647
	Item no.: 210-719 Operating tool; Blade: 2.5 x 0.4 mm; with a partially insulated shaft	www.wago.com/210-719
Carrier rail		
Mounting accessories		
	Item no.: 210-295 Steel carrier rail; 15 x 5.5 mm; 1 mm thick; 2 m long; unslotted; according to EN 60715; silver-colored	www.wago.com/210-295

Subject to changes. Please also observe the further product documentation!



Item no.: 210-296
Aluminum carrier rail; 15 x 5.5 mm; 1 mm thick; 2 m long; unslotted; similar to EN 60715; silver-colored

www.wago.com/210-296



Item no.: 210-111
Steel carrier rail; 15 x 5.5 mm; 1 mm thick; 2 m long; slotted; according to EN 60715; silver-colored

www.wago.com/210-111

Jumpers

Jumper

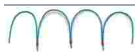

Item no.: 210-123
Wire commoning chain; insulated; blue

www.wago.com/210-123



Item no.: 2000-408
Jumper; 8-way; insulated; light gray

www.wago.com/2000-408



Item no.: 2000-407
Jumper; 7-way; insulated; light gray

www.wago.com/2000-407



Item no.: 2000-409
Jumper; 9-way; insulated; light gray

www.wago.com/2000-409



Item no.: 2000-408/000-006
Jumper; 8-way; insulated; blue

www.wago.com/2000-408/000-006



Item no.: 2000-408/000-005
Jumper; 8-way; insulated; red

www.wago.com/2000-408/000-005



Item no.: 2000-409/000-005
Jumper; 9-way; insulated; red

www.wago.com/2000-409/000-005



Item no.: 2000-407/000-006
Jumper; 7-way; insulated; blue

www.wago.com/2000-407/000-006



Item no.: 2000-410
Jumper; 10-way; insulated; light gray

www.wago.com/2000-410



Item no.: 2000-410/000-006
Jumper; 10-way; insulated; blue















www.wago.com/2000-410/000-006

















Item no.: 2000-433/000-005
Jumper; from 1 to 3; insulated; red

www.wago.com/2000-433/000-005

Subject to changes. Please also observe the further product documentation!

	Item no.: 2000-407/000-005 Jumper; 7-way; insulated; red	www.wago.com/2000-407/000-005
	Item no.: 2000-433/000-006 Jumper; from 1 to 3; insulated; blue	www.wago.com/2000-433/000-006
	Item no.: 2000-410/000-005 Jumper; 10-way; insulated; red	www.wago.com/2000-410/000-005
	Item no.: 2000-435 Jumper; from 1 to 5; insulated; light gray	www.wago.com/2000-435
	Item no.: 2000-409/000-006 Jumper; 9-way; insulated; blue	www.wago.com/2000-409/000-006
	Item no.: 2000-436 Jumper; from 1 to 6; insulated; light gray	www.wago.com/2000-436
	Item no.: 2000-433 Jumper; from 1 to 3; insulated; light gray	www.wago.com/2000-433
	Item no.: 2000-434 Jumper; from 1 to 4; insulated; light gray	www.wago.com/2000-434
	Item no.: 2000-402 Jumper; 2-way; insulated; light gray	www.wago.com/2000-402
	Item no.: 2000-402/000-006 Jumper; 2-way; insulated; blue	www.wago.com/2000-402/000-006
	Item no.: 2000-403 Jumper; 3-way; insulated; light gray	www.wago.com/2000-403
	Item no.: 2000-402/000-005 Jumper; 2-way; insulated; red	www.wago.com/2000-402/000-005
	Item no.: 2000-402/000-018 Jumper; 2-way; insulated; yellow-green	www.wago.com/2000-402/000-018
	Item no.: 2000-404 Jumper; 4-way; insulated; light gray	www.wago.com/2000-404
	Item no.: 2000-403/000-005 Jumper; 3-way; insulated; red	www.wago.com/2000-403/000-005

Subject to changes. Please also observe the further product documentation!

	Item no.: 2000-404/000-006 Jumper; 4-way; insulated; blue	www.wago.com/2000-404/000-006
	Item no.: 2000-403/000-006 Jumper; 3-way; insulated; blue	www.wago.com/2000-403/000-006
	Item no.: 2000-404/000-005 Jumper; 4-way; insulated; red	www.wago.com/2000-404/000-005
	Item no.: 2000-405 Jumper; 5-way; insulated; light gray	www.wago.com/2000-405
	Item no.: 2000-405/011-000 Star point jumper; 3-way; insulated; light gray	www.wago.com/2000-405/011-000
	Item no.: 2000-405/000-006 Jumper; 5-way; insulated; blue	www.wago.com/2000-405/000-006
	Item no.: 2000-406/000-006 Jumper; 6-way; insulated; blue	www.wago.com/2000-406/000-006
	Item no.: 2000-405/000-005 Jumper; 5-way; insulated; red	www.wago.com/2000-405/000-005
	Item no.: 2000-406 Jumper; 6-way; insulated; light gray	www.wago.com/2000-406
	Item no.: 2000-406/000-005 Jumper; 6-way; insulated; red	www.wago.com/2000-406/000-005
	Item no.: 2000-406/020-000 Delta jumper; insulated; light gray	www.wago.com/2000-406/020-000
	Item no.: 2000-437 Jumper; from 1 to 7; insulated; light gray	www.wago.com/2000-437
	Item no.: 2000-438 Jumper; from 1 to 8; insulated; light gray	www.wago.com/2000-438
	Item no.: 2000-439 Jumper; from 1 to 9; insulated; light gray	www.wago.com/2000-439
	Item no.: 2000-440	

Subject to changes. Please also observe the further product documentation!

Jumper; from 1 to 10; insulated; light gray

www.wago.com/2000-440**Item no.: 210-103**

Wire commoning chain; insulated; black

www.wago.com/210-103**Ferrule**

Ferrule

**Item no.: 216-241**Ferrule; Sleeve for 0.5 mm² / 20 AWG; insulated; electro-tin plated; electrolytic copper; gastight crimped; acc. to DIN 46228, Part 4/09.90; whitewww.wago.com/216-241**Item no.: 216-242**Ferrule; Sleeve for 0.75 mm² / 18 AWG; insulated; electro-tin plated; electrolytic copper; gastight crimped; acc. to DIN 46228, Part 4/09.90; graywww.wago.com/216-242**Item no.: 216-243**Ferrule; Sleeve for 1 mm² / AWG 18; insulated; electro-tin plated; electrolytic copper; gastight crimped; acc. to DIN 46228, Part 4/09.90; redwww.wago.com/216-243**Mounting**

Cover carrier

**Item no.: 709-169**

Cover carrier; Type 3; gray

www.wago.com/709-169

Cover

**Item no.: 709-156**

Cover; Type 3; suitable for cover carrier, type 3; 1 m long; transparent

www.wago.com/709-156

Mounting accessories

**Item no.: 249-101**

Screwless end stop; 6 mm wide; for WMB markers; gray

www.wago.com/249-101**Push-in type wire jumper**

Jumper

**Item no.: 2009-404**Push-in type wire jumper; 0.75 mm²; insulated; 110 mm long; graywww.wago.com/2009-404**Item no.: 2009-402**Push-in type wire jumper; 0.75 mm²; insulated; 60 mm long; graywww.wago.com/2009-402**Item no.: 2009-406**Push-in type wire jumper; 0.75 mm²; insulated; 250 mm long; graywww.wago.com/2009-406**Testing and measuring**

Testing accessories

**Item no.: 2009-174**

Test plug adapter; for 4 mm Ø test plugs; for testing TOPJOB®S rail-mounted terminal blocks; gray

www.wago.com/2009-174

Subject to changes. Please also observe the further product documentation!

WAGO GmbH & Co. KG

Hansastr. 27

32423 Minden

Phone: +49571 887-0 | Fax: +49571 887-169

Email: info.de@wago.com | Web: www.wago.com

Do you have any questions about our products?

We are always happy to take your call at +49 (571) 887-44222.



Item no.: 2009-182

Testing tap; for max. 2.5 mm²; tool-free connection for individual test wires 0.08 - 2.5 mm; gray

www.wago.com/2009-182



Item no.: 210-136

Test plug; 2 mm Ø; with 500 mm cable; red

www.wago.com/210-136

Downloads

Documentation

Additional Information

Technical Section	pdf	Download
Technical explanations	2.2 MB	

CAD/CAE-Data

CAD data

2D/3D Models 2250-1207	URL	Download
------------------------	-----	----------

CAE data

ZUKEN Portal 2250-1207	URL	Download
------------------------	-----	----------

EPLAN Data Portal 2250-1207	URL	Download
-----------------------------	-----	----------

	URL	Download
--	-----	----------

Environmental Product Compliance

Compliance Search

Environmental Product Compliance 2250-1207	URL	Download
--	-----	----------

2-conductor miniature ground terminal block; with push-button; 1 mm²; side and center marking; for DIN-15 rail; Push-in CAGE CLAMP®; 1,00 mm²; green-yellow

Installation Notes

Installation

Subject to changes. Please also observe the further product documentation!

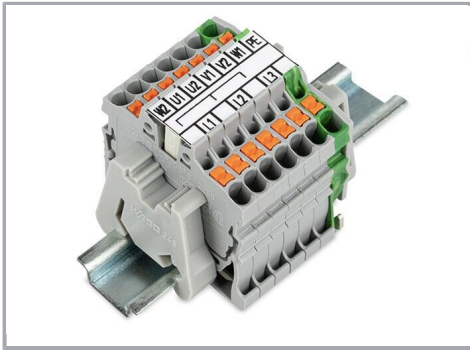

Conductor termination



Insert solid conductors via push-in termination.



Insert ferruled conductors via push-in termination.



Insert fine-stranded conductors via operating tool.

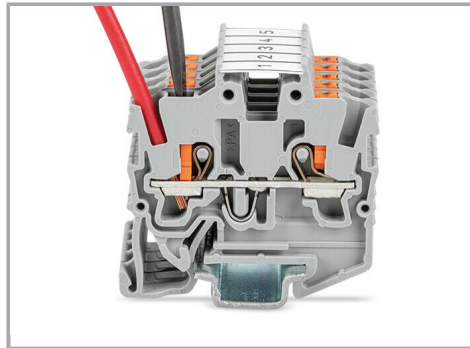

Remove all conductors via operating tool.

Commoning

Subject to changes. Please also observe the further product documentation!

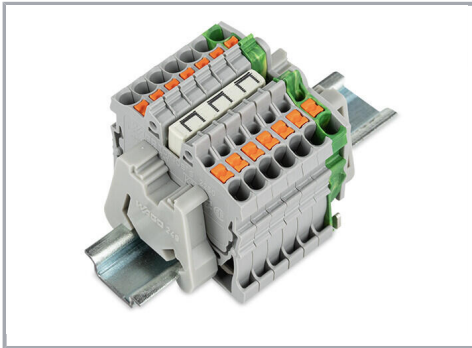

Insert a delta jumper and push down until it hits the backstop (example shows terminal blocks with push-buttons).

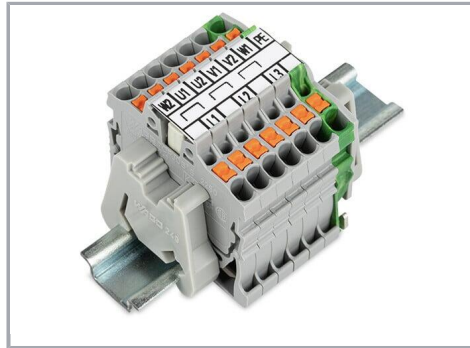

Marking strip (2009-110) inserted in the marking slot with jumper symbols of the inserted jumper (delta jumper) (example shows terminal blocks with push-buttons)

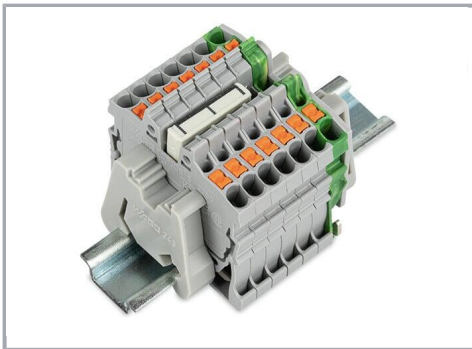

Insert a star point jumper and push down until it hits the backstop (example shows terminal blocks with push-buttons).

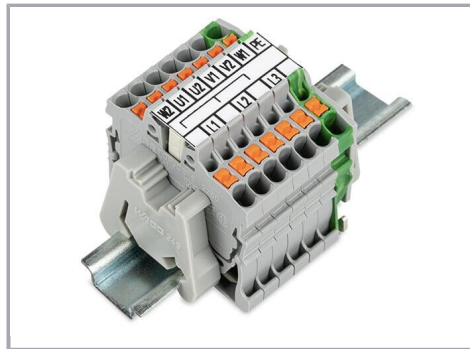

Marking strip (2009-110) inserted in the marking slot with jumper symbols of the inserted jumper (2000-405/011-000 Delta Jumper) (example shows terminal blocks with push-buttons)

Testing



Testing with a 2 mm \varnothing 210-136 Test Plug (max. 42 V).

Subject to changes. Please also observe the further product documentation!

Marking

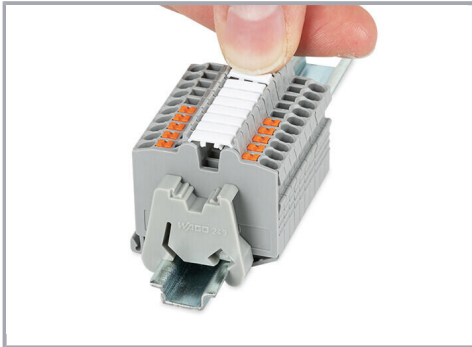

Snapping a marking strip into the marker slot.

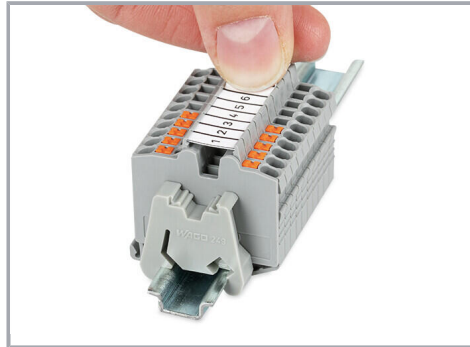

Snapping a marking strip (2009-110) into a marker slot.

Product family

TOPJOB® S

TOPJOB® S: In various industrial applications and modern building installations, WAGO's wide and versatile range of rail-mount terminal blocks provides more than just reliable electrical connections.

[Show all products from the family](#)

Subject to changes. Please also observe the further product documentation!