

## G2-LAURA-RS-P

~8° spot beam. Assembly with thinner white holder, installation tape and location pins.

### SPECIFICATION:

Dimensions	21.6 x 21.6 mm
Height	13.1 mm
Fastening	tape, pin
ROHS compliant	yes ⓘ



### MATERIALS:

Component	Type	Material	Colour	Finish
LAURA-RS	Single lens	PMMA	clear	
LAURA-LT-PIN-XP-HLD-WHT	Holder	PC	white	
ROSE-TAPE	Tape	Acrylic foam	black	

### ORDERING INFORMATION:

Component	Type	Qty in box	MOQ	MPQ	Box weight (kg)
CA13628_G2-LAURA-RS-P	Single lens	1440	360	180	5.9
» Box size: 460 x 260 x 160 mm					

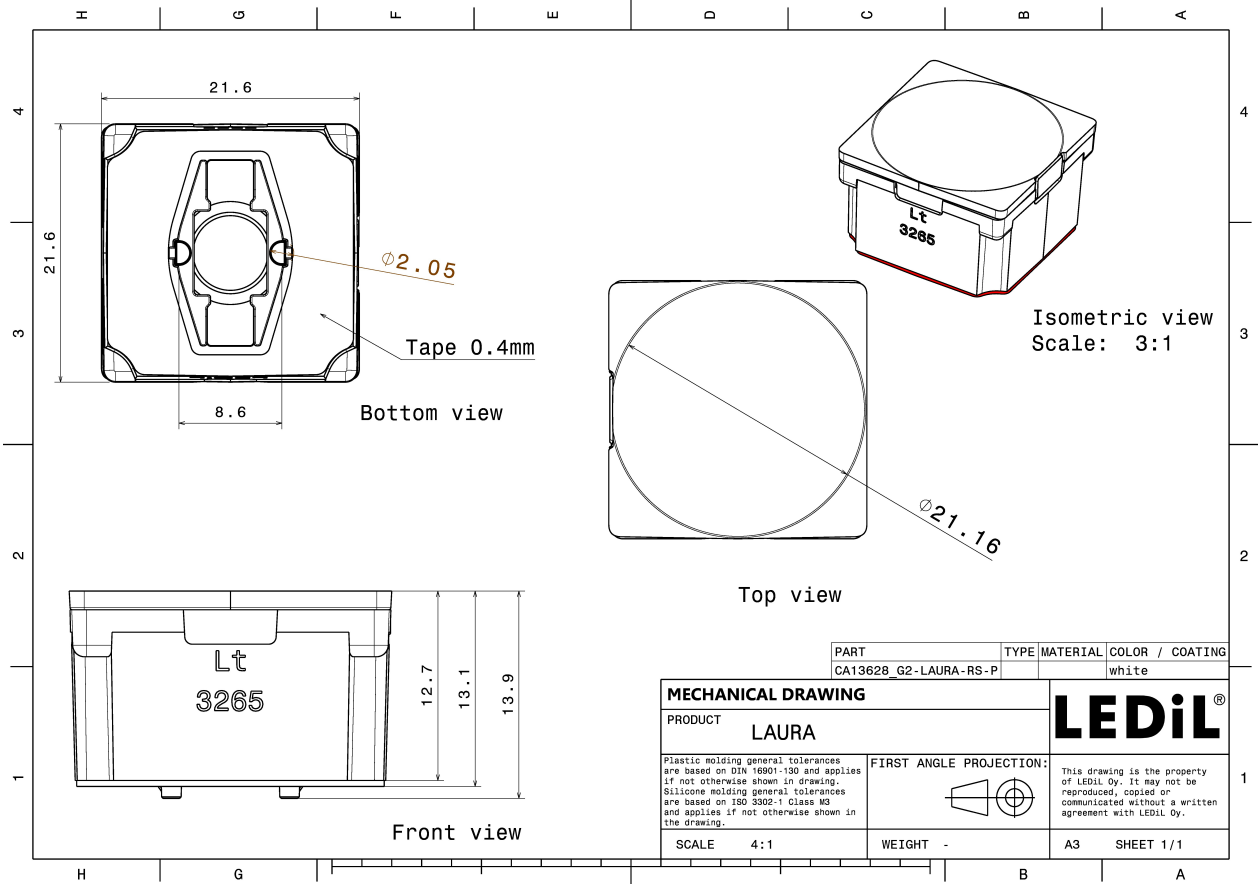

See also our general installation guide: [www.ledil.com/installation\\_guide](http://www.ledil.com/installation_guide)

#### OPTICAL RESULTS (MEASURED):

##### CREE LED

LED XB-H  
 FWHM / FWTM 11.0° / 20.0°  
 Efficiency 91 %  
 Peak intensity 20.5 cd/lm  
 LEDs/each optic 1  
 Light colour White  
 Required components:

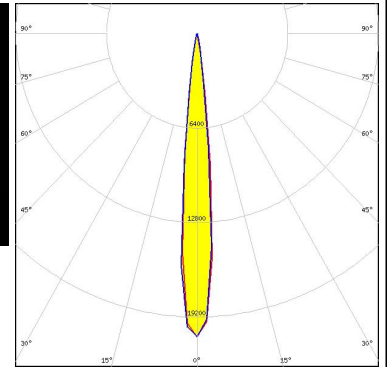

##### CREE LED

LED XP-E  
 FWHM / FWTM 8.0° / 16.0°  
 Efficiency 93 %  
 Peak intensity 33.2 cd/lm  
 LEDs/each optic 1  
 Light colour White  
 Required components:

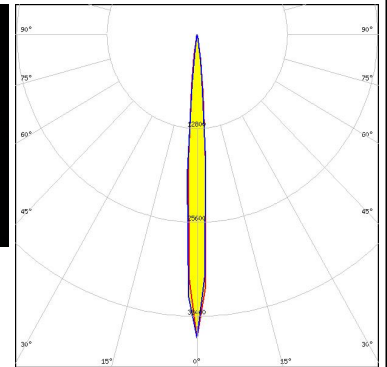

##### CREE LED

LED XP-E2  
 FWHM / FWTM 8.0° / 15.0°  
 Efficiency 91 %  
 Peak intensity 41.4 cd/lm  
 LEDs/each optic 1  
 Light colour White  
 Required components:

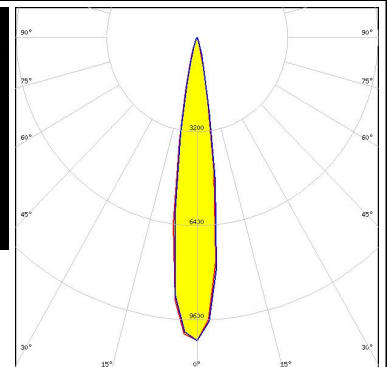
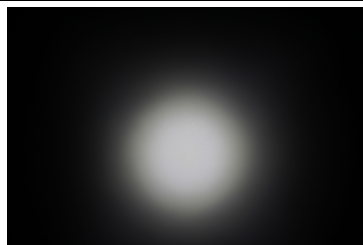

##### CREE LED

LED XP-L HD  
 FWHM / FWTM 16.0° / 27.0°  
 Efficiency 90 %  
 Peak intensity 10.3 cd/lm  
 LEDs/each optic 1  
 Light colour White  
 Required components:

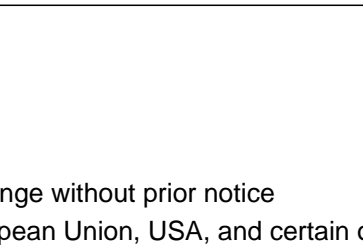

#### OPTICAL RESULTS (MEASURED):



LED XQ-E HI  
 FWHM / FWTM 5.0° / 11.0°  
 Efficiency 94 %  
 Peak intensity 65.3 cd/lm  
 LEDs/each optic 1  
 Light colour White  
 Required components:

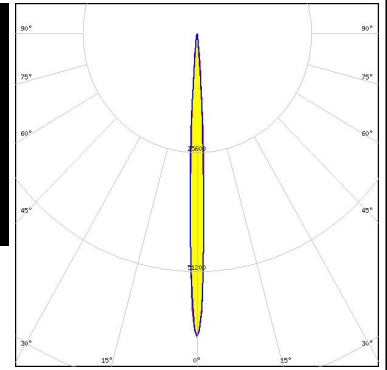

LED LUXEON 3030 2D (Round LES)  
 FWHM / FWTM 9.0° / 20.0°  
 Efficiency 92 %  
 Peak intensity 22.7 cd/lm  
 LEDs/each optic 1  
 Light colour White  
 Required components:

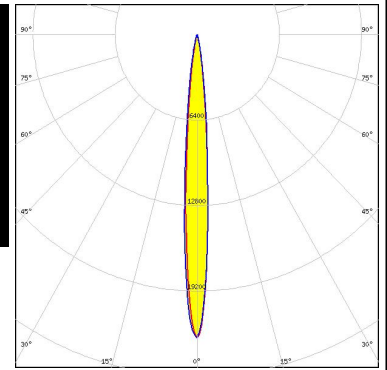
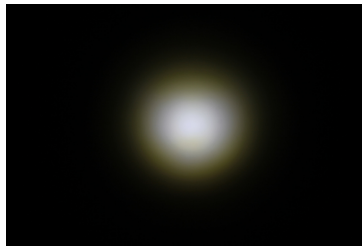



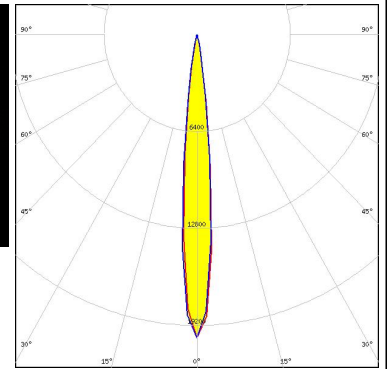

LED LUXEON TX  
 FWHM / FWTM 11.0° / 21.0°  
 Efficiency 90 %  
 Peak intensity 20 cd/lm  
 LEDs/each optic 1  
 Light colour White  
 Required components:

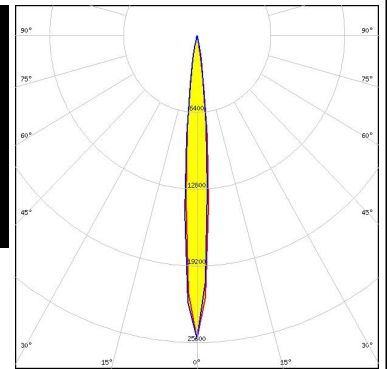

LED NCSxx19A  
 FWHM / FWTM 10.0° / 20.0°  
 Efficiency 90 %  
 Peak intensity 25.3 cd/lm  
 LEDs/each optic 1  
 Light colour White  
 Required components:

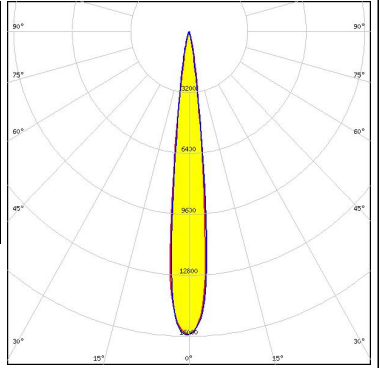

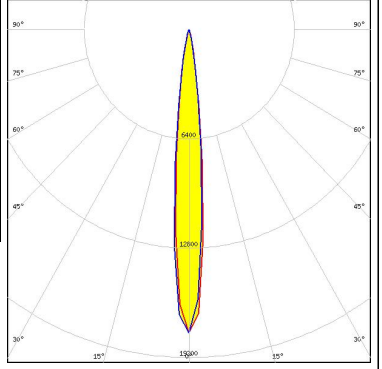
#### OPTICAL RESULTS (MEASURED):

<p><b>NICHIA</b></p> <p>LED NVSW219D            FWHM / FWTM 12.0° / 22.0°            Efficiency 94 %            Peak intensity 15.9 cd/lm            LEDs/each optic 1            Light colour White            Required components:</p>		
<p><b>NICHIA</b></p> <p>LED NVSxx19A            FWHM / FWTM 12.0° / 23.0°            Efficiency 90 %            Peak intensity 17.8 cd/lm            LEDs/each optic 1            Light colour White            Required components:</p>		
<p><b>NICHIA</b></p> <p>LED NVSxx19B/NVSxx19C            FWHM / FWTM 12.0° / 24.0°            Efficiency 90 %            Peak intensity 16.3 cd/lm            LEDs/each optic 1            Light colour White            Required components:</p>		
<p><b>OSRAM</b>  <small>Opto Semiconductors</small></p> <p>LED PLPVEC2 850A            FWHM / FWTM 6.0° / 14.0°            Efficiency %            LEDs/each optic 1            Light colour IR            Required components:</p>		

#### OPTICAL RESULTS (MEASURED):

### SAMSUNG

LED LH351D  
 FWHM / FWTM 16.0° / 29.0°  
 Efficiency 94 %  
 Peak intensity 9 cd/lm  
 LEDs/each optic 1  
 Light colour White  
 Required components:

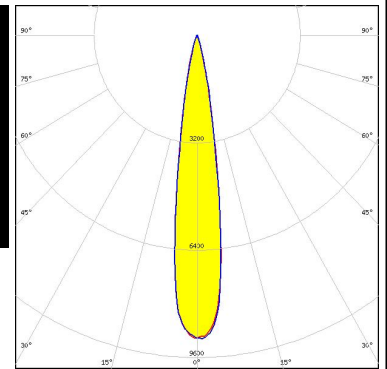
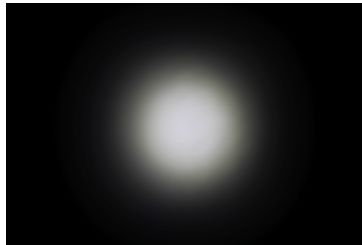

SEOUL SEMICONDUCTOR

LED Z5M1/Z5M2  
 FWHM / FWTM 11.0° / 19.0°  
 Efficiency 91 %  
 Peak intensity 20 cd/lm  
 LEDs/each optic 1  
 Light colour White  
 Required components:

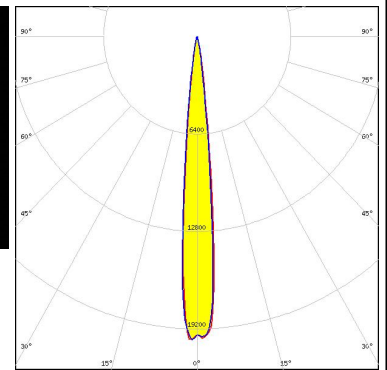





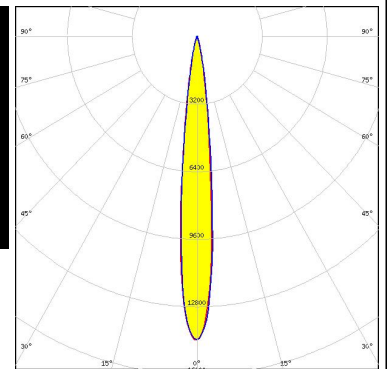

SEOUL SEMICONDUCTOR

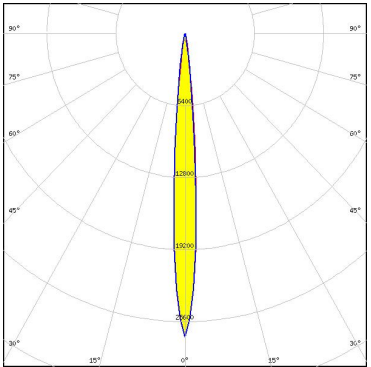
LED Z5M3  
 FWHM / FWTM 12.0° / 24.0°  
 Efficiency 94 %  
 Peak intensity 14.4 cd/lm  
 LEDs/each optic 1  
 Light colour White  
 Required components:

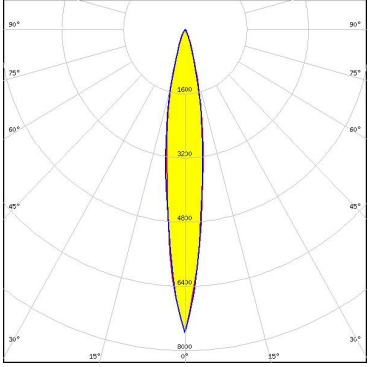

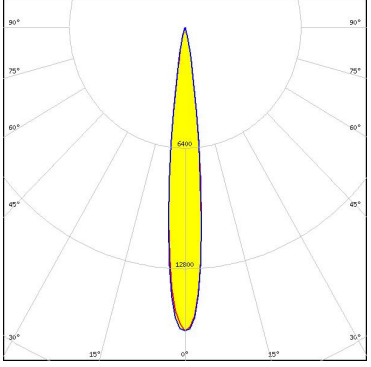
#### OPTICAL RESULTS (SIMULATED):

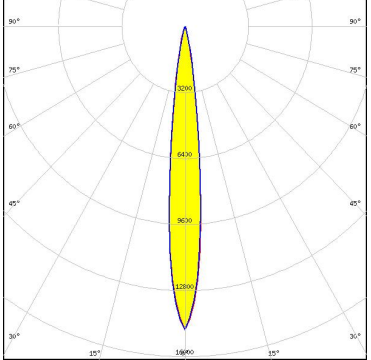
	<p>LED: XD16            FWHM / FWTM: 9.0° / 18.0°            Efficiency: 93 %            Peak intensity: 27 cd/lm            LEDs/each optic: 1            Light colour: White            Required components:</p>	
	<p>LED: XHP35 HD            FWHM / FWTM: 14.0° / 35.0°            Efficiency: 94 %            Peak intensity: 7.6 cd/lm            LEDs/each optic: 1            Light colour: White            Required components:</p>	
	<p>LED: XHP35 HI            FWHM / FWTM: 12.0° / 23.0°            Efficiency: 94 %            Peak intensity: 16.1 cd/lm            LEDs/each optic: 1            Light colour: White            Required components:</p>	
	<p>LED: XP-G3            FWHM / FWTM: 12.0° / 24.0°            Efficiency: 92 %            Peak intensity: 14.7 cd/lm            LEDs/each optic: 1            Light colour: White            Required components:</p>	

#### OPTICAL RESULTS (SIMULATED):

##### CREE LED

LED XP-P  
 FWHM / FWTM 6.0° / 14.0°  
 Efficiency 94 %  
 Peak intensity 53.2 cd/lm  
 LEDs/each optic 1  
 Light colour White  
 Required components:

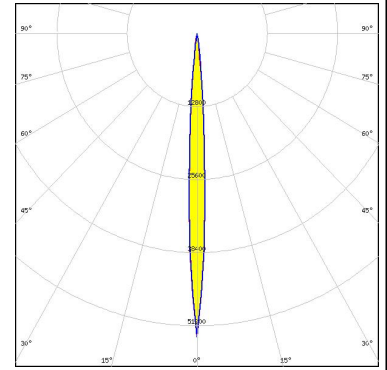

##### CREE LED

LED XQ-E HD  
 FWHM / FWTM 6.9° / 14.5°  
 Efficiency 94 %  
 Peak intensity 44.9 cd/lm  
 LEDs/each optic 1  
 Light colour White  
 Required components:

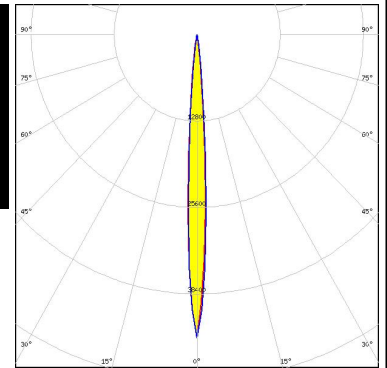
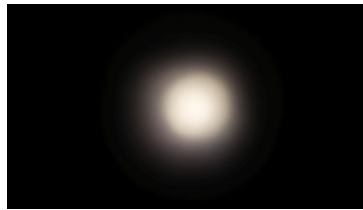

##### LUMILEDS

LED LUXEON CZ  
 FWHM / FWTM 6.0° / 13.0°  
 Efficiency 95 %  
 Peak intensity 54.3 cd/lm  
 LEDs/each optic 1  
 Light colour White  
 Required components:

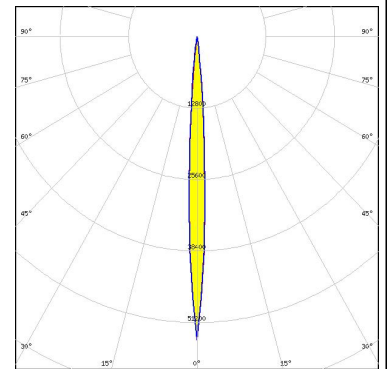

##### LUMILEDS

LED LUXEON HL1Z  
 FWHM / FWTM 8.0° / 16.0°  
 Efficiency 95 %  
 Peak intensity 33.8 cd/lm  
 LEDs/each optic 1  
 Light colour White  
 Required components:

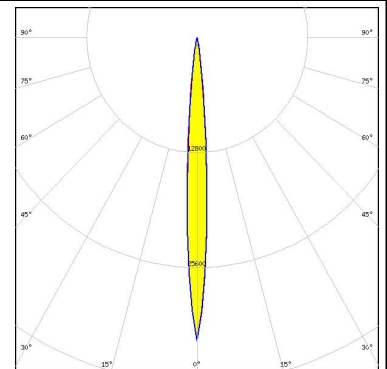

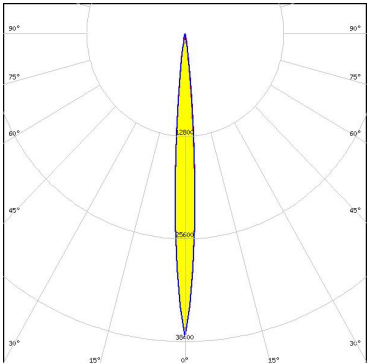
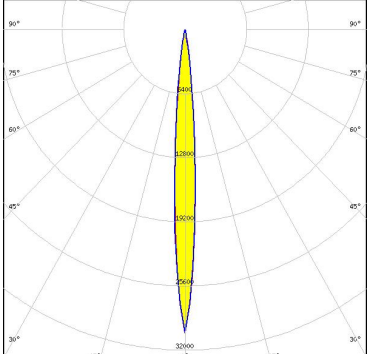
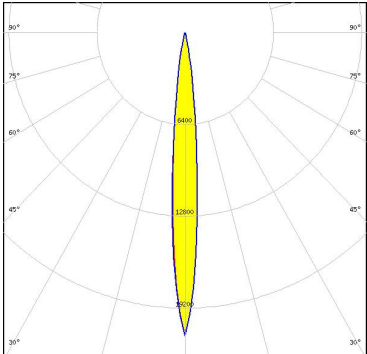
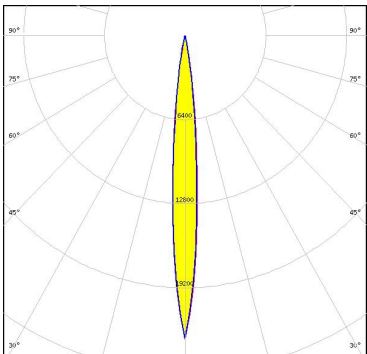

#### OPTICAL RESULTS (SIMULATED):

<p><b>LUMILEDS</b></p> <p>LED LUXEON Z ES</p> <p>FWHM / FWTM 8.0° / 16.0°</p> <p>Efficiency 95 %</p> <p>Peak intensity 37.8 cd/lm</p> <p>LEDs/each optic 1</p> <p>Light colour White</p> <p>Required components:</p>	
<p><b>NICHIA</b></p> <p>LED NCSxE17A</p> <p>FWHM / FWTM 8.0° / 18.0°</p> <p>Efficiency 95 %</p> <p>Peak intensity 30.3 cd/lm</p> <p>LEDs/each optic 1</p> <p>Light colour White</p> <p>Required components:</p>	
<p><b>NICHIA</b></p> <p>LED NVSxE21A</p> <p>FWHM / FWTM 10.0° / 21.0°</p> <p>Efficiency 94 %</p> <p>Peak intensity 21.1 cd/lm</p> <p>LEDs/each optic 1</p> <p>Light colour White</p> <p>Required components:</p>	
<p><b>OSRAM</b> Opto Semiconductors</p> <p>LED OSLO Black</p> <p>FWHM / FWTM 9.5° / 20.0°</p> <p>Efficiency 97 %</p> <p>Peak intensity 23 cd/lm</p> <p>LEDs/each optic 1</p> <p>Light colour White</p> <p>Required components:</p>	

#### OPTICAL RESULTS (SIMULATED):

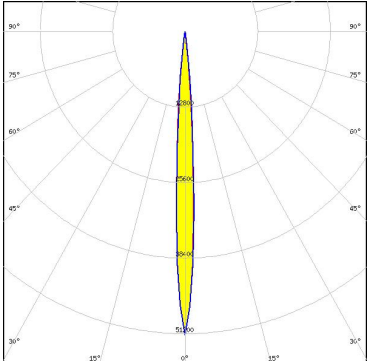
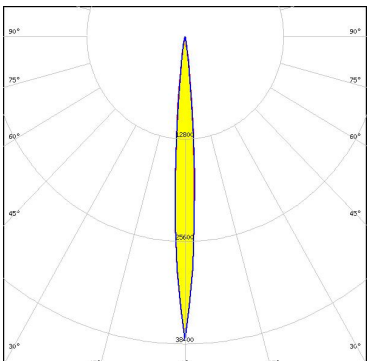
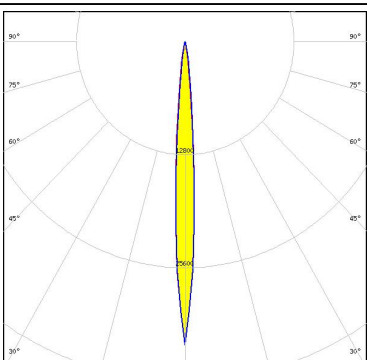
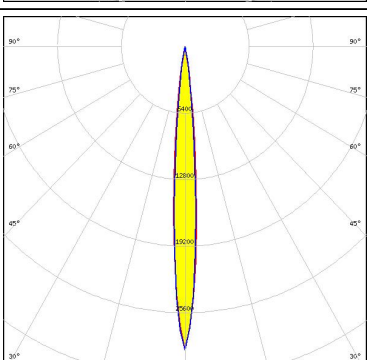
<p><b>OSRAM</b> Opto Semiconductors</p> <p>LED OSLON Black Flat (LUW HWQP)</p> <p>FWHM / FWTM 6.8° / 14.0°</p> <p>Efficiency 94 %</p> <p>Peak intensity 48.3 cd/lm</p> <p>LEDs/each optic 1</p> <p>Light colour White</p> <p>Required components:</p>	
<p><b>OSRAM</b> Opto Semiconductors</p> <p>LED OSLON SSL 150</p> <p>FWHM / FWTM 8.0° / 16.0°</p> <p>Efficiency 95 %</p> <p>Peak intensity 37.9 cd/lm</p> <p>LEDs/each optic 1</p> <p>Light colour White</p> <p>Required components:</p>	
<p><b>OSRAM</b> Opto Semiconductors</p> <p>LED OSLON SSL 80</p> <p>FWHM / FWTM 8.0° / 16.0°</p> <p>Efficiency 95 %</p> <p>Peak intensity 34.3 cd/lm</p> <p>LEDs/each optic 1</p> <p>Light colour White</p> <p>Required components:</p>	
<p><b>OSRAM</b> Opto Semiconductors</p> <p>LED SFH 4715S</p> <p>FWHM / FWTM 9.0° / 18.0°</p> <p>Efficiency 95 %</p> <p>Peak intensity 29.2 cd/lm</p> <p>LEDs/each optic 1</p> <p>Light colour IR</p> <p>Required components:</p>	

### OPTICAL RESULTS (SIMULATED):

#### OSRAM

Opto Semiconductors

LED SFH 4770S  
FWHM / FWTM 10.0° / 23.0°  
Efficiency 94 %  
LEDs/each optic 1  
Light colour White  
Required components:

#### SAMSUNG

LED LH351B  
FWHM / FWTM 12.0° / 24.0°  
Efficiency 95 %  
Peak intensity 15.6 cd/lm  
LEDs/each optic 1  
Light colour White  
Required components:

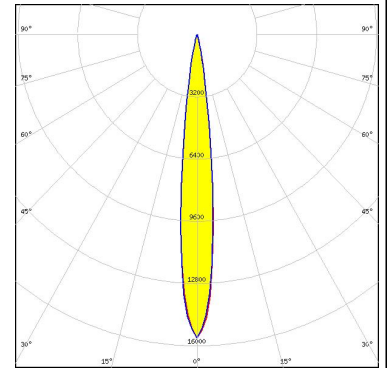

#### SAMSUNG

LED LH351Z  
FWHM / FWTM 10.0° / 18.0°  
Efficiency 93 %  
Peak intensity 25 cd/lm  
LEDs/each optic 1  
Light colour White  
Required components:

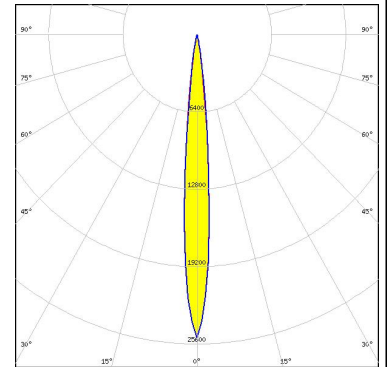

### GENERAL INFORMATION:

NOTE: The typical beam angle will be changed by different color, chip size and chip position tolerance. The typical total beam angle is the full angle measured where the luminous intensity is half of the peak value.

### MATERIALS:

As part of our continuous research and improvement processes, and to ensure the best possible quality and availability of our products, LEDiL reserves the right to change material grades without notice.

### PRODUCT DATA USER AGREEMENT AND DISCLAIMER:

The measured data in the provided downloadable LEDiL Product Datasheets and Mechanical 2D-Drawings is rounded and provided as reference for planning. LEDiL Oy's optical specifications have been verified by conducting performance testing of the products in accordance with the company's quality system. The reported data are averaged results of multiple measurements with typical variation. LEDiL Oy reserves the right to without prior notification make changes and improvements to its products.

LEDiL Oy assumes neither warranty, nor guarantee nor any other liability of any kind for the contents and correctness of the provided data. The provided data has been generated with highest diligence but the provided data may in reality not represent the complete possible variation range of all intrinsic parameters. Therefore, in certain cases a deviation from the provided data could occur.

LEDiL Oy reserves the right to undertake technical changes of its products without further notification which could lead to changes in the provided data. LEDiL Oy assumes no liability of any kind for the possible deviation from any provided data or any other damage resulting from the usage of the provided data.

The user agrees to this disclaimer and user agreement with the download or usage of the provided files.

#### LEDiL Oy

Joensuunkatu 13  
FI-24240 SALO  
Finland

#### LEDiL Inc.

228 West Page Street  
Suite D  
Sycamore IL 60178  
USA

#### Ledil Optics Technology (Shenzhen) Co., Ltd.

# 405 , Block B  
Casic Motor Building  
Shenzhen 518057  
P.R.CHINA

#### Local sales and technical support

[www.ledil.com/  
where\\_to\\_buy](http://www.ledil.com/where_to_buy)

#### Shipping locations

Salo, Finland  
Hong Kong, China

#### Distribution Partners

[www.ledil.com/  
where\\_to\\_buy](http://www.ledil.com/where_to_buy)