

CTLSH3-30M833

SURFACE MOUNT SILICON
LOW V_F
SCHOTTKY RECTIFIER



www.centrasemi.com

DESCRIPTION:

The CENTRAL SEMICONDUCTOR CTLSH3-30M833 is a high performance 3.0 Amp silicon Schottky rectifier designed for applications where small size and operational efficiency are prime requirements. With a maximum power dissipation of 4.5W, this leadless package design has a watts per unit area at least twice that of equivalent packaged devices.

MARKING CODE: CHA1



• Device is **Halogen Free** by design

FEATURES:

- High Current ($I_F=3.0A$)
- High Thermal Efficiency
- Low Leakage/Low V_F
- 3 x 3mm TLM™ case

MAXIMUM RATINGS: ($T_A=25^\circ C$)

	SYMBOL		UNITS
Continuous Reverse Voltage	V_R	30	V
Average Forward Current	I_O	3.0	A
Peak Forward Surge Current, $t_p=8.3ms$	I_{FSM}	25	A
Power Dissipation (Note 1)	P_D	4.5	W
Power Dissipation (Note 2)	P_D	4.0	W
Power Dissipation (Note 3)	P_D	2.5	W
Operating and Storage Junction Temperature	T_J, T_{stg}	-65 to +150	$^\circ C$
Thermal Resistance (Note 1)	θ_{JA}	27.78	$^\circ C/W$
Thermal Resistance (Note 2)	θ_{JA}	31.25	$^\circ C/W$
Thermal Resistance (Note 3)	θ_{JA}	50.00	$^\circ C/W$

Notes: (1) Ceramic or aluminum core PC Board with copper mounting pad area of 75mm²
(2) FR-4 Epoxy PC Board with copper mounting pad area of 75mm²
(3) FR-4 Epoxy PC Board with copper mounting pad area of 25mm²

ELECTRICAL CHARACTERISTICS: ($T_A=25^\circ C$ unless otherwise noted)

SYMBOL	TEST CONDITIONS	MIN	MAX	UNITS
I_R	$V_R=30V$		1.0	mA
BV_R	$I_R=5.0mA$	30		V
V_F	$I_F=500mA$		0.30	V
V_F	$I_F=1.0A$		0.35	V
V_F	$I_F=2.0A$		0.40	V
V_F	$I_F=3.0A$		0.45	V

R7 (7-August 2015)

CTLSH3-30M833
SURFACE MOUNT SILICON
LOW V_F
SCHOTTKY RECTIFIER



TLM833 CASE - MECHANICAL OUTLINE

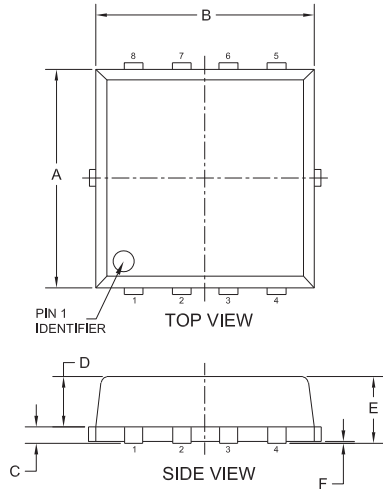

SYMBOL	INCHES		MILLIMETERS	
	MIN	MAX	MIN	MAX
A	0.114	0.122	2.90	3.10
B	0.114	0.122	2.90	3.10
C	0.006	0.010	0.15	0.25
D	0.026	0.030	0.65	0.75
E	0.031	0.039	0.80	1.00
F	0.000	0.002	0.00	0.05
G	0.008	0.018	0.20	0.45
H	0.026		0.65	
J	--	0.005	--	0.125
K	0.007	0.012	0.17	0.30
L	--	0.005	--	0.125
M	0.011	0.015	0.29	0.39
N	0.049	0.057	1.25	1.45
P	0.006	0.014	0.15	0.35
Q	0.040	0.048	1.01	1.21
R	0.085	0.093	2.16	2.36
S	0.012	0.016	0.30	0.40

TLM833 (REV:R3)

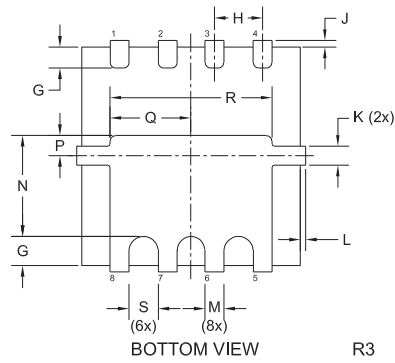

R3

SUGGESTED MOUNTING PADS
(Dimensions in mm)

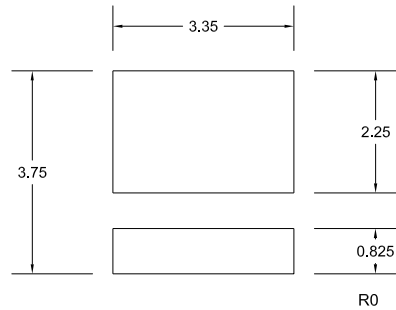

For standard mounting see
TLM833 package details

LEAD CODE:

- 1) Anode
- 2) Anode
- 3) Anode
- 4) Anode
- 5) Cathode
- 6) Cathode
- 7) Cathode
- 8) Cathode

MARKING CODE: CHA1

R7 (7-August 2015)

CTLSH3-30M833

SURFACE MOUNT SILICON
LOW V_F
SCHOTTKY RECTIFIER



TYPICAL ELECTRICAL CHARACTERISTICS

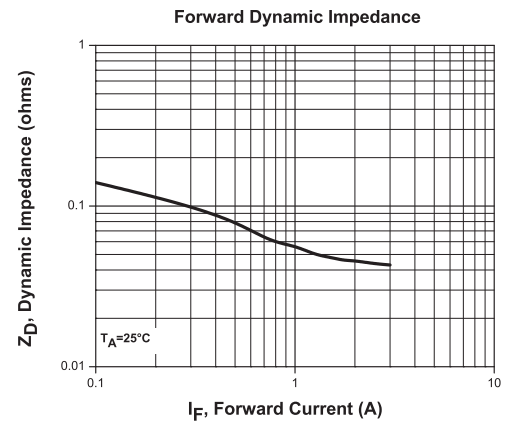
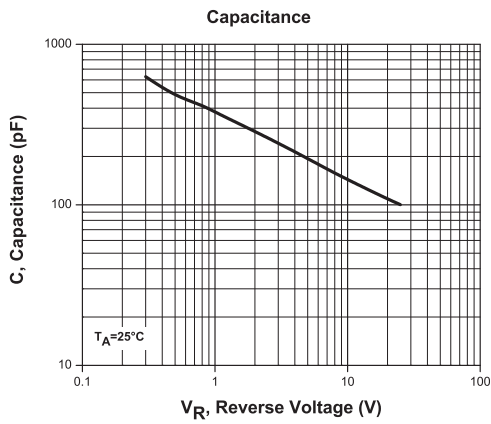
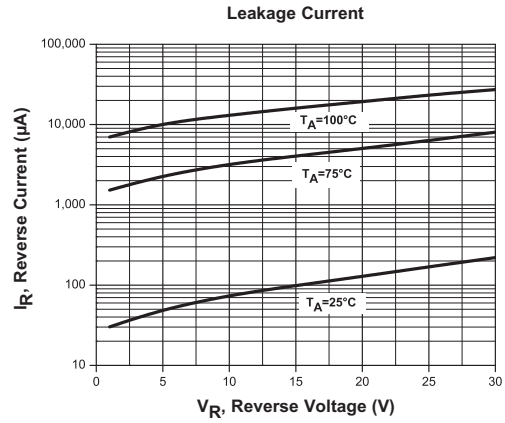
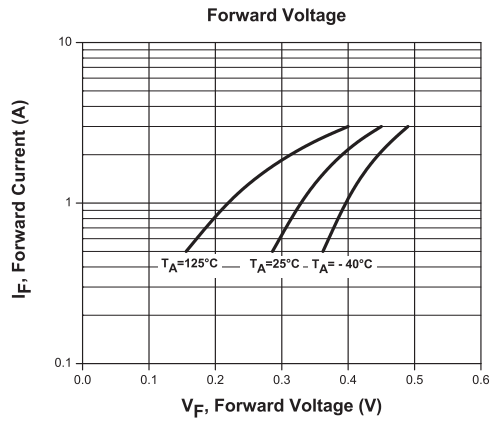

R7 (7-August 2015)

CTLSH3-30M833

SURFACE MOUNT SILICON
LOW V_F
SCHOTTKY RECTIFIER



TYPICAL ELECTRICAL CHARACTERISTICS

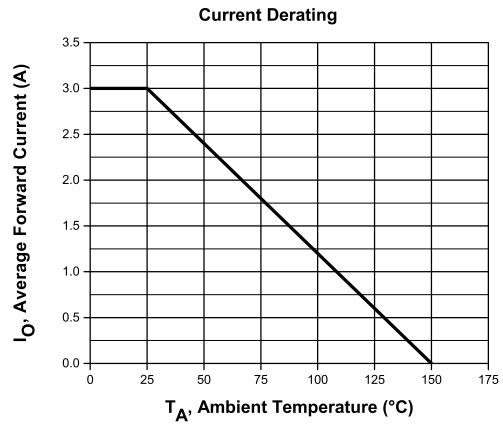
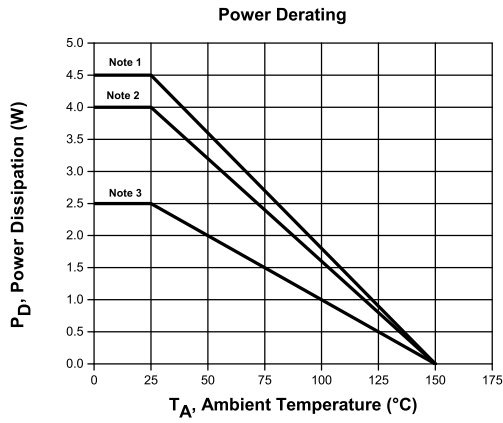

Notes: (1) Ceramic or aluminum core PC Board with copper mounting pad area of 75mm²
(2) FR-4 Epoxy PC Board with copper mounting pad area of 75mm²
(3) FR-4 Epoxy PC Board with copper mounting pad area of 25mm²

R7 (7-August 2015)

OUTSTANDING SUPPORT AND SUPERIOR SERVICES



PRODUCT SUPPORT

Central's operations team provides the highest level of support to insure product is delivered on-time.

- Supply management (Customer portals)
- Inventory bonding
- Consolidated shipping options
- Custom bar coding for shipments
- Custom product packing

DESIGNER SUPPORT/SERVICES

Central's applications engineering team is ready to discuss your design challenges. Just ask.

- Free quick ship samples (2nd day air)
- Online technical data and parametric search
- SPICE models
- Custom electrical curves
- Environmental regulation compliance
- Customer specific screening
- Up-screening capabilities
- Special wafer diffusions
- PbSn plating options
- Package details
- Application notes
- Application and design sample kits
- Custom product and package development

REQUESTING PRODUCT PLATING

1. If requesting Tin/Lead plated devices, add the suffix "TIN/LEAD" to the part number when ordering (example: 2N2222A TIN/LEAD).
2. If requesting Lead (Pb) Free plated devices, add the suffix "PBFREE" to the part number when ordering (example: 2N2222A PBFREE).

CONTACT US

Corporate Headquarters & Customer Support Team

Central Semiconductor Corp.
145 Adams Avenue
Hauppauge, NY 11788 USA
Main Tel: (631) 435-1110
Main Fax: (631) 435-1824
Support Team Fax: (631) 435-3388
www.centrasemi.com

Worldwide Field Representatives:
www.centrasemi.com/wwreps

Worldwide Distributors:
www.centrasemi.com/wwdistributors

For the latest version of Central Semiconductor's **LIMITATIONS AND DAMAGES DISCLAIMER**, which is part of Central's Standard Terms and Conditions of sale, visit: www.centrasemi.com/terms

Product End of Life Notification

PDN ID:	PDN01000 Rev:001
Notification Date:	2/08/21
Last Buy Date:	Varies
Last Shipment Date	Varies

Summary: The devices listed below were previously discontinued on or before August 3, 2015. Rev:001 of PDN#01000: February 5, 2021, is being issued to remove part numbers CMPTA42 and CMPTA92 from the PDN to address new market demand; CMPTA42 and CMPTA92 are now active devices.

Although Central Semiconductor Corp. makes every effort to continue to produce devices that have been proclaimed EOL (End of Life) by other manufacturers, it is an accepted industry practice to discontinue certain devices when customer demand falls below a minimum level of sustainability. Accordingly, the following product(s) have been transitioned to End of Life status as part of Central's ongoing Product Management Process. Any replacement products are noted below. The effective date for placing last purchase orders will be six (6) months from the date of this notice and twelve (12) months from the notice date for final shipments, and minimum order quantities may apply. The last purchase and shipment dates may be extended if inventory is available.

*** All Plating types (PBFREE, TIN/LEAD) for each item listed are included in this notice.**

<u>Central Part Number</u>	<u>Replacement</u>
CBRSDSH5-40 TR13	N/A, Stock Only
CBRSDSH5-60 BK	N/A, Stock Only
CBRSDSH5-60 TR13	N/A, Stock Only
CCLHM080 BK	CMJH080 BK
CCLHM080 TR	CMJH080 TR
CCLHM100 BK	CMJH100 BK
CCLHM100 TR	CMJH100 TR
CCLHM120 BK	CMJH120 BK
CCLHM120 TR	CMJH120 TR
CCLHM150 BK	CMJH150 BK
CCLHM150 TR	CMJH150 TR
CCLM0035 BK	N/A, Stock Only
CCLM0035 TR	N/A, Stock Only
CCLM0130 BK	CMJ0130 BK
CCLM0130 TR	CMJ0130 TR
CCLM0300 BK	CMJ0300 BK
CCLM0300 TR	CMJ0300 TR
CCLM0500 BK	CMJ0500 BK
CCLM0500 TR	CMJ0500 TR
CCLM0750 BK	CMJ0750 BK
CCLM0750 TR	CMJ0750 TR
CCLM1000 BK	CMJ1000 BK
CCLM1000 TR	CMJ1000 TR
CCLM1500 BK	CMJ1500 BK
CCLM1500 TR	CMJ1500 TR
CCLM2000 BK	CMJ2000 BK
CCLM2000 TR	CMJ2000 TR
CCLM2700 BK	CMJ2700 BK
CCLM2700 TR	CMJ2700 TR
CCLM3500 BK	CMJ3500 BK
CCLM3500 TR	CMJ3500 TR
CCLM4500 BK	CMJ4500 BK
CCLM4500 TR	CMJ4500 TR
CCLM5750 BK	CMJ5750 BK

*** CONTINUED ***

DISCLAIMER: This End of Life (EOL) notification is in accordance with JEDEC standard JESD48 - Product Discontinuance. Central Semiconductor Corp. will make every effort to offer life-time buy (LTB) opportunities and/or offer replacement devices to existing customers for discontinued devices, however, one or both may not be possible for all devices. Please contact your local Central Semiconductor sales representative for LTB opportunities/additional information.

Product End of Life Notification

PDN ID:	PDN01000 Rev:001
Notification Date:	2/08/21
Last Buy Date:	Varies
Last Shipment Date	Varies

*** CONTINUED FROM PRIOR PAGE ***

* All Plating types (PBFREE,TIN/LEAD) for each item listed are included in this notice.

<u>Central Part Number</u>	<u>Replacement</u>
CCLM5750 TR	CMJ5750 TR
CED2838E BK	N/A, Stock Only
CED2838E TR	N/A, Stock Only
CLLR1-01 BK	CMR1-01M BK
CLLR1-01 TR	CMR1-01M TR13
CLLR1-02 BK	CMR1-02M BK
CLLR1-02 TR	CMR1-02M TR13
CLLR1-04 BK	CMR1-04M BK
CLLR1-04 TR	CMR1-04M TR13
CLLR1-06 BK	CMR1-06M BK
CLLR1-06 TR	CMR1-06M TR13
CLLR1-06 TR13	CMR1-06M TR13
CLLR1-10 BK	CMR1-10M BK
CLLR1-10 TR	CMR1-10M TR13
CLLR1-10 TR13	CMR1-10M TR13
CLLR1F-02 BK	CMR1F-02M BK
CLLR1F-02 TR	CMR1F-02M TR13
CLLR1F-06 BK	CMR1F-06M BK
CLLR1F-06 TR	CMR1F-06M TR13
CLLR1F-10 BK	CMR1F-10M BK
CLLR1F-10 TR	CMR1F-10M TR13
CLLR1U-01 BK	CMR1U-01M BK
CLLR1U-01 TR	CMR1U-01M TR13
CLLR1U-02 BK	CMR1U-02M BK
CLLR1U-02 TR	CMR1U-02M TR13
CLLR1U-04 BK	CMR1U-04M BK
CLLR1U-04 TR	CMR1U-04M TR13
CLLSH1-20 BK	CMSH1-20M BK
CLLSH1-20 TR	CMSH1-20M TR13
CLLSH1-20 TR13	N/A, Stock Only
CLLSH1-40 BK	CMSH1-40M BK
CLLSH1-40 TR	CMSH1-40M TR13
CLLSH1-60 BK	CMSH1-60M BK
CLLSH1-60 TR	CMSH1-60M TR13
CLL4104 BK	CMHZ4104 BK
CLL4104 TR	CMHZ4104 TR
CLL4116 BK	CMHZ4116 BK
CLL4116 TR	CMHZ4116 TR
CLL4122 TR	CMHZ4122 TR
CLL457A BK	CMHD457A BK
CLL457A TR	CMHD457A TR
CLL459A BK	CMHD459A BK
CLL459A TR	CMHD459A TR

*** CONTINUED ***

DISCLAIMER: This End of Life (EOL) notification is in accordance with JEDEC standard JESD48 - Product Discontinuance. Central Semiconductor Corp. will make every effort to offer life-time buy (LTB) opportunities and/or offer replacement devices to existing customers for discontinued devices, however, one or both may not be possible for all devices. Please contact your local Central Semiconductor sales representative for LTB opportunities/additional information.

Product End of Life Notification

PDN ID:	PDN01000 Rev:001
Notification Date:	2/08/21
Last Buy Date:	Varies
Last Shipment Date	Varies

*** CONTINUED FROM PRIOR PAGE ***

* All Plating types (PBFREE,TIN/LEAD) for each item listed are included in this notice.

<u>Central Part Number</u>	<u>Replacement</u>
CLL4614 BK	CMHZ4614 BK
CLL4614 TR	CMHZ4614 TR
CLL4615 BK	CMHZ4615 BK
CLL4617 BK	CMHZ4617 BK
CLL4617 TR	CMHZ4617 TR
CLL4619 BK	CMHZ4619 BK
CLL4619 TR	CMHZ4619 TR
CLL4620 BK	CMHZ4620 BK
CLL4620 TR	CMHZ4620 TR
CLL4625 BK	CMHZ4625 BK
CLL4625 TR	CMHZ4625 TR
CLL4626 BK	CMHZ4626 BK
CLL4626 TR	CMHZ4626 TR
CLL4627 BK	CMHZ4627 BK
CLL4627 TR	CMHZ4627 TR
CLL4678 BK	CMHZ4678 BK
CLL4678 TR	CMHZ4678 TR
CLL4679 BK	CMHZ4679 BK
CLL4679 TR	CMHZ4679 TR
CLL4680 BK	CMHZ4680 BK
CLL4680 TR	CMHZ4680 TR
CLL4681 BK	CMHZ4681 BK
CLL4681 TR	CMHZ4681 TR
CLL4682 TR	CMHZ4682 TR
CLL4683 BK	CMHZ4683 BK
CLL4683 TR	CMHZ4683 TR
CLL4684 BK	CMHZ4684 BK
CLL4684 TR	CMHZ4684 TR
CLL4685 BK	CMHZ4685 BK
CLL4685 TR	CMHZ4685 TR
CLL4686 BK	CMHZ4686 BK
CLL4687 BK	CMHZ4687 BK
CLL4687 TR	CMHZ4687 TR
CLL4688 BK	CMHZ4688 BK
CLL4688 TR	CMHZ4688 TR
CLL4689 BK	CMHZ4689 BK
CLL4689 TR	CMHZ4689 TR
CLL4690 BK	CMHZ4690 BK
CLL4690 TR	CMHZ4690 TR
CLL4690C BK	CMHZ4690C BK
CLL4691 BK	CMHZ4691 BK
CLL4691 TR	CMHZ4691 TR
CLL4692 BK	CMHZ4692 BK

*** CONTINUED ***

DISCLAIMER: This End of Life (EOL) notification is in accordance with JEDEC standard JESD48 - Product Discontinuance. Central Semiconductor Corp. will make every effort to offer life-time buy (LTB) opportunities and/or offer replacement devices to existing customers for discontinued devices, however, one or both may not be possible for all devices. Please contact your local Central Semiconductor sales representative for LTB opportunities/additional information.

Product End of Life Notification

PDN ID:	PDN01000 Rev:001
Notification Date:	2/08/21
Last Buy Date:	Varies
Last Shipment Date	Varies

*** CONTINUED FROM PRIOR PAGE ***

* All Plating types (PBFREE,TIN/LEAD) for each item listed are included in this notice.

<u>Central Part Number</u>	<u>Replacement</u>
CLL4692 TR	CMHZ4692 TR
CLL4693 BK	CMHZ4693 BK
CLL4693 TR	CMHZ4693 TR
CLL4694 BK	CMHZ4694 BK
CLL4694 TR	CMHZ4694 TR
CLL4694C BK	CMHZ4694C BK
CLL4694C TR	CMHZ4694C TR
CLL4696 BK	CMHZ4696 BK
CLL4696 TR	CMHZ4696 TR
CLL4697 BK	CMHZ4697 BK
CLL4697 TR	CMHZ4697 TR
CLL4698 BK	CMHZ4698 BK
CLL4698 TR	CMHZ4698 TR
CLL4699 BK	CMHZ4699 BK
CLL4699 TR	CMHZ4699 TR
CLL4700 BK	CMHZ4700 BK
CLL4700 TR	CMHZ4700 TR
CLL4701 BK	CMHZ4701 BK
CLL4702 BK	CMHZ4702 BK
CLL4702 TR	CMHZ4702 TR
CLL4703 BK	CMHZ4703 BK
CLL4703 TR	CMHZ4703 TR
CLL4704 BK	CMHZ4704 BK
CLL4704 TR	CMHZ4704 TR
CLL4705 BK	CMHZ4705 BK
CLL4705 TR	CMHZ4705 TR
CLL4707 BK	CMHZ4707 BK
CLL4707 TR	CMHZ4707 TR
CLL4708 BK	CMHZ4708 BK
CLL4709 BK	CMHZ4709 BK
CLL4709 TR	CMHZ4709 TR
CLL4709C BK	CMHZ4709C BK
CLL4709C TR	CMHZ4709C TR
CLL4711 BK	CMHZ4711 BK
CLL4711 TR	CMHZ4711 TR
CLL4713 BK	CMHZ4713 BK
CLL4713 TR	CMHZ4713 TR
CLL4714 BK	CMHZ4714 BK
CLL4715 BK	CMHZ4715 BK
CLL4716 BK	CMHZ4716 BK
CLL4717 BK	CMHZ4717 BK
CLL4728 BK	N/A, Stock Only
CLL4728 TR	N/A, Stock Only

*** CONTINUED ***

DISCLAIMER: This End of Life (EOL) notification is in accordance with JEDEC standard JESD48 - Product Discontinuance. Central Semiconductor Corp. will make every effort to offer life-time buy (LTB) opportunities and/or offer replacement devices to existing customers for discontinued devices, however, one or both may not be possible for all devices. Please contact your local Central Semiconductor sales representative for LTB opportunities/additional information.

Product End of Life Notification

PDN ID:	PDN01000 Rev:001
Notification Date:	2/08/21
Last Buy Date:	Varies
Last Shipment Date	Varies

*** CONTINUED FROM PRIOR PAGE ***

* All Plating types (PBFREE,TIN/LEAD) for each item listed are included in this notice.

<u>Central Part Number</u>	<u>Replacement</u>
CLL5001 BK	CMPD5001 BK
CLL5001 TR	CMPD5001 TR
CLL5221B BK	CMHZ5221B BK
CLL5221B TR	CMHZ5221B TR
CLL5222A BK	N/A, Stock Only
CLL5222B BK	CMHZ5222B BK
CLL5222B TR	CMHZ5222B TR
CMEDA-6I BK	N/A, Stock Only
CMEDA-6I TR	N/A, Stock Only
CMPD300 BK	N/A, Stock Only
CMPD400 BK	N/A, Stock Only
CMPT3640 BK	CMPT4209 TR
CMPT3640 TR	CMPT4209 TR
CMWSH-4 BK	N/A, Stock Only
CMWSH-4 TR	N/A, Stock Only
CMZ5337D TR13	N/A, Stock Only
CMZ5918C BK	N/A, Stock Only
CN5281B BK	N/A, Stock Only
CN5281B TR	N/A, Stock Only
CN695 BK	N/A, Stock Only
CN695 TR	N/A, Stock Only
CR250-2 BK	N/A, Stock Only
CR250-2 TR	N/A, Stock Only
CR250-3 BK	N/A, Stock Only
CR250-3 TR	N/A, Stock Only
CR250F-3 BK	N/A, Stock Only
CR250F-3 TR	N/A, Stock Only
CR250F-4 BK	N/A, Stock Only
CR250F-4 TR	N/A, Stock Only
CR3-005 BK	N/A, Stock Only
CR3-005 TR	N/A, Stock Only
CR3-010 BK	N/A, Stock Only
CR3-010 TR	N/A, Stock Only
CR3-020 BK	N/A, Stock Only
CR3-020 TR	N/A, Stock Only
CR3-040 BK	N/A, Stock Only
CR3-040 TR	N/A, Stock Only
CR3-060 BK	N/A, Stock Only
CR3-060 TR	N/A, Stock Only
CR3-080 BK	N/A, Stock Only
CR3-100 BK	N/A, Stock Only
CR3-120 BK	N/A, Stock Only
CR3-120 TR	N/A, Stock Only

*** CONTINUED ***

DISCLAIMER: This End of Life (EOL) notification is in accordance with JEDEC standard JESD48 - Product Discontinuance. Central Semiconductor Corp. will make every effort to offer life-time buy (LTB) opportunities and/or offer replacement devices to existing customers for discontinued devices, however, one or both may not be possible for all devices. Please contact your local Central Semiconductor sales representative for LTB opportunities/additional information.

Product End of Life Notification

PDN ID:	PDN01000 Rev:001
Notification Date:	2/08/21
Last Buy Date:	Varies
Last Shipment Date	Varies

*** CONTINUED FROM PRIOR PAGE ***

* All Plating types (PBFREE,TIN/LEAD) for each item listed are included in this notice.

<u>Central Part Number</u>	<u>Replacement</u>
CR3U-100 BK	N/A, Stock Only
CR6AF2 BK	CR6AF2GPP BK
CR6A4 BK	CR6A4GPP BK
CR6A4 TR	N/A, Stock Only
CSMS15 BK	N/A, Stock Only
CSMS15 TR	N/A, Stock Only
CSMS24 BK	N/A, Stock Only
CSMS24 TR	N/A, Stock Only
CSTB162 BK	N/A, Stock Only
CSTB165 BK	N/A, Stock Only
CSTB567 BK	CMXSTB200 TR
CSTB568 BK	N/A, Stock Only
CSTB569 BK	N/A, Stock Only
CTLDM7003T-M563D BK	N/A, Stock Only
CTLDM7003T-M563D TR	N/A, Stock Only
CTLDM7120-M832D BK	N/A, Stock Only
CTLDM7120-M832D TR	N/A, Stock Only
CTLDM7181-M832D BK	N/A, Stock Only
CTLDM7181-M832D TR	N/A, Stock Only
CTLDM8120-M832D BK	N/A, Stock Only
CTLDM8120-M832D TR	N/A, Stock Only
CTLM1034-M832D BK	N/A, Stock Only
CTLM1034-M832D TR	N/A, Stock Only
CTLM1074-M832D BK	N/A, Stock Only
CTLM1074-M832D TR	N/A, Stock Only
CTLM3410-M832D BK	N/A, Stock Only
CTLM3410-M832D TR	N/A, Stock Only
CTLM3474-M832D BK	N/A, Stock Only
CTLM3474-M832D TR	N/A, Stock Only
CTLM7110-M832D BK	N/A, Stock Only
CTLM7110-M832D TR	N/A, Stock Only
CTLM7410-M832D BK	N/A, Stock Only
CTLM7410-M832D TR	N/A, Stock Only
CTLM8110-M832D BK	N/A, Stock Only
CTLM8110-M832D TR	N/A, Stock Only
CTLSH1-40M322 BK	N/A, Stock Only
CTLSH1-40M322 TR	N/A, Stock Only
CTLSH1-40M563 BK	N/A, Stock Only
CTLSH1-40M563 TR	N/A, Stock Only
CTLSH1-40M832D BK	N/A, Stock Only
CTLSH1-40M832D TR	N/A, Stock Only
CTLSH10-60M856 BK	N/A, Stock Only
CTLSH10-60M856 TR13	N/A, Stock Only

*** CONTINUED ***

DISCLAIMER: This End of Life (EOL) notification is in accordance with JEDEC standard JESD48 - Product Discontinuance. Central Semiconductor Corp. will make every effort to offer life-time buy (LTB) opportunities and/or offer replacement devices to existing customers for discontinued devices, however, one or both may not be possible for all devices. Please contact your local Central Semiconductor sales representative for LTB opportunities/additional information.

Product End of Life Notification

PDN ID:	PDN01000 Rev:001
Notification Date:	2/08/21
Last Buy Date:	Varies
Last Shipment Date	Varies

*** CONTINUED FROM PRIOR PAGE ***

* All Plating types (PBFREE,TIN/LEAD) for each item listed are included in this notice.

<u>Central Part Number</u>	<u>Replacement</u>
CTLSH2-40M832 BK	N/A, Stock Only
CTLSH2-40M832 TR	N/A, Stock Only
CTLSH3-30M833 BK	N/A, Stock Only
CTLSH3-30M833 TR	N/A, Stock Only
CTLSH5-40M833 BK	CTLSH5-40M833S TR
CTLSH5-40M833 TR	CTLSH5-40M833S TR
CTLS5064-M532 BK	N/A, Stock Only
CTLS5064-M532 TR	N/A, Stock Only
CTLS5064R-M532 BK	N/A, Stock Only
CTLS5064R-M532 TR	N/A, Stock Only
CTLT3410-M521 BK	N/A, Stock Only
CTLT3410-M521 TR	N/A, Stock Only
CTLT5551-M832D TR	N/A, Stock Only
CTLT7410-M521 BK	N/A, Stock Only
CTLT7410-M521 TR	N/A, Stock Only
CTLT853-M833 BK	N/A, Stock Only
CTLT853-M833 TR	N/A, Stock Only
CTLT953-M833 BK	N/A, Stock Only
CTLT953-M833 TR	N/A, Stock Only
CYTA44D BK	N/A, Stock Only
CYTA44D TR	N/A, Stock Only
CYTA4494D BK	N/A, Stock Only
CYTA4494D TR	N/A, Stock Only
CYT5551D BK	N/A, Stock Only
CYT5551D TR	N/A, Stock Only
CYT5551HCD BK	N/A, Stock Only
CYT5551HCD TR	N/A, Stock Only
CYT7090LD BK	N/A, Stock Only
CYT7090LD TR	N/A, Stock Only
CZT900K BK	N/A, Stock Only
CZT900K TR	N/A, Stock Only
MMPQ2222A BK	N/A, Stock Only
MMPQ2222A TR13	N/A, Stock Only
MMPQ2907A BK	N/A, Stock Only
MMPQ3904 BK	N/A, Stock Only
MMPQ3904 TR13	N/A, Stock Only
MMPQ3906 TR13	N/A, Stock Only
MMPQ6502 BK	N/A, Stock Only
MMPQ6502 TR13	N/A, Stock Only
PN3640-18	PN4209
PN3640-5	PN4209
PN4258 TRE	N/A, Stock Only
PN4258-18	N/A, Stock Only

*** CONTINUED ***

DISCLAIMER: This End of Life (EOL) notification is in accordance with JEDEC standard JESD48 - Product Discontinuance. Central Semiconductor Corp. will make every effort to offer life-time buy (LTB) opportunities and/or offer replacement devices to existing customers for discontinued devices, however, one or both may not be possible for all devices. Please contact your local Central Semiconductor sales representative for LTB opportunities/additional information.

Product End of Life Notification

PDN ID:	PDN01000 Rev:001
Notification Date:	2/08/21
Last Buy Date:	Varies
Last Shipment Date	Varies

*** CONTINUED FROM PRIOR PAGE ***

* All Plating types (PBFREE,TIN/LEAD) for each item listed are included in this notice.

<u>Central Part Number</u>	<u>Replacement</u>
PN5910 TRE	PN4209
PN5910-18	PN4209
PN5910-5	PN4209
1N277 BK	N/A, Stock Only
1N277 TR	N/A, Stock Only
1N34A BK	N/A, Stock Only
1N34A TR	N/A, Stock Only
1N355 BK	N/A, Stock Only
1N4444 BK	N/A, Stock Only
1N4444 TR	N/A, Stock Only
1N4634 BK	N/A, Stock Only
1N4944 BK	1N4946 BK
1N4944 TR	1N4946 TR
1N5333B BK	N/A, Stock Only
1N5333B TR	N/A, Stock Only
1N5334B BK	N/A, Stock Only
1N5335B BK	N/A, Stock Only
1N5335B TR	N/A, Stock Only
1N5336B BK	N/A, Stock Only
1N5336B TR	N/A, Stock Only
1N5337B BK	N/A, Stock Only
1N5338B BK	CZ5338B BK
1N5338B TR	CZ5338B TR
1N5339B BK	CZ5339B BK
1N5339C BK	N/A, Stock Only
1N5339C TR	N/A, Stock Only
1N5340B BK	CZ5340B BK
1N5341B BK	CZ5341B BK
1N5341C BK	N/A, Stock Only
1N5342B BK	CZ5342B BK
1N5342C BK	N/A, Stock Only
1N5343B BK	CZ5343B BK
1N5343C BK	N/A, Stock Only
1N5344B BK	CZ5344B BK
1N5344B TR	CZ5344B TR
1N5345B BK	CZ5345B BK
1N5346B BK	CZ5346B BK
1N5346B TR	CZ5346B TR
1N5347B BK	CZ5347B BK
1N5348B BK	CZ5348B BK
1N5349B BK	CZ5349B BK
1N5350B BK	CZ5350B BK
1N5350C BK	N/A, Stock Only

*** CONTINUED ***

DISCLAIMER: This End of Life (EOL) notification is in accordance with JEDEC standard JESD48 - Product Discontinuance. Central Semiconductor Corp. will make every effort to offer life-time buy (LTB) opportunities and/or offer replacement devices to existing customers for discontinued devices, however, one or both may not be possible for all devices. Please contact your local Central Semiconductor sales representative for LTB opportunities/additional information.

Product End of Life Notification

PDN ID:	PDN01000 Rev:001
Notification Date:	2/08/21
Last Buy Date:	Varies
Last Shipment Date	Varies

*** CONTINUED FROM PRIOR PAGE ***

* All Plating types (PBFREE,TIN/LEAD) for each item listed are included in this notice.

<u>Central Part Number</u>	<u>Replacement</u>
1N5351B BK	CZ5351B BK
1N5351B TR	CZ5351B TR
1N5351C BK	N/A, Stock Only
1N5352B BK	N/A, Stock Only
1N5352B TR	CZ5352B TR
1N5355B BK	CZ5355B BK
1N5356B BK	CZ5356B BK
1N5357B BK	CZ5357B BK
1N5358B BK	CZ5358B BK
1N5359B BK	CZ5359B BK
1N5359B TR	CZ5359B TR
1N5360B BK	CZ5360B BK
1N5361B BK	CZ5361B BK
1N5362B BK	N/A, Stock Only
1N5362B TR	CZ5362B TR
1N5364B BK	CZ5364B BK
1N5364B TR	CZ5364B TR
1N5365B BK	CZ5365B BK
1N5365B TR	CZ5365B TR
1N5368B BK	CZ5368B BK
1N5370B BK	CZ5370B BK
1N5370B TR	CZ5370B TR
1N5373B BK	CZ5373B BK
1N5373B TR	N/A, Stock Only
1N5374B BK	N/A, Stock Only
1N5375B BK	N/A, Stock Only
1N5376B BK	N/A, Stock Only
1N5377B BK	N/A, Stock Only
1N5377B TR	N/A, Stock Only
1N5378B BK	N/A, Stock Only
1N5378B TR	N/A, Stock Only
1N5380B BK	N/A, Stock Only
1N5380B TR	N/A, Stock Only
1N5382B BK	N/A, Stock Only
1N5383B BK	N/A, Stock Only
1N5384B BK	N/A, Stock Only
1N5386B BK	N/A, Stock Only
1N5387B BK	N/A, Stock Only
1N5388B BK	N/A, Stock Only
1N5388B TR	N/A, Stock Only
1N5416 BK	1N5419 BK
1N5416 TR	1N5419 TR
1N5417 BK	1N5419 BK

*** CONTINUED ***

DISCLAIMER: This End of Life (EOL) notification is in accordance with JEDEC standard JESD48 - Product Discontinuance. Central Semiconductor Corp. will make every effort to offer life-time buy (LTB) opportunities and/or offer replacement devices to existing customers for discontinued devices, however, one or both may not be possible for all devices. Please contact your local Central Semiconductor sales representative for LTB opportunities/additional information.

Product End of Life Notification

PDN ID:	PDN01000 Rev:001
Notification Date:	2/08/21
Last Buy Date:	Varies
Last Shipment Date	Varies

*** CONTINUED FROM PRIOR PAGE ***

* All Plating types (PBFREE,TIN/LEAD) for each item listed are included in this notice.

<u>Central Part Number</u>	<u>Replacement</u>
1N5417 TR	1N5419 TR
1N5418 BK	1N5419 BK
1N5418 TR	1N5419 TR
1N5559B BK	1N4736A BK
1N5559B TR	1N4736A TR
1N5565B BK	1N4742A BK
1N5565B TR	1N4742A TR
1N5586B BK	N/A, Stock Only
1N60 BK	N/A, Stock Only
1N6263 BK	CMDD6263 BK
1N6263 TR	CMDD6263 TR
1N6263 TR4K	CMDD6263 TR
1N6373 BK	1.5CE6.8A BK
1N6373 TR	1.5CE6.8A TR
1N64 BK	N/A, Stock Only
1N645 BK	N/A, Stock Only
1N645 TR	N/A, Stock Only
1N647 BK	N/A, Stock Only
1N649 BK	N/A, Stock Only
1N67A BK	N/A, Stock Only
1N774 BK	N/A, Stock Only
1N821A BK	CMKTC825A BK
1N821A TR	CMKTC825A TR
1N823A BK	CMKTC825A BK
1N823A DO-7 BK	CMKTC825A BK
1N823A DO-7 TR	CMKTC825A BK
1N823A TR	CMKTC825A TR
1N825A BK	CMKTC825A BK
1N825A DO-7 BK	CMKTC825A BK
1N825A TR	CMKTC825A TR
1N827A BK	CMKTC825A BK
1N827A DO-7 BK	CMKTC825A BK
1N827A TR	CMKTC825A TR
1N829A BK	CMKTC825A BK
1N829A DO-7 BK	CMKTC825A BK
1N829A TR	CMKTC825A TR
1N87A BK	N/A, Stock Only
1N87A TR	N/A, Stock Only
1N888 BK	N/A, Stock Only
1N914B BK	N/A, Stock Only
1N914B TR	N/A, Stock Only
2N5771 TRE	PN4209
2N5771-5T	N/A, Stock Only

*** CONTINUED ***

DISCLAIMER: This End of Life (EOL) notification is in accordance with JEDEC standard JESD48 - Product Discontinuance. Central Semiconductor Corp. will make every effort to offer life-time buy (LTB) opportunities and/or offer replacement devices to existing customers for discontinued devices, however, one or both may not be possible for all devices. Please contact your local Central Semiconductor sales representative for LTB opportunities/additional information.



http://www.centrasemi.com

Product End of Life Notification

PDN ID:	PDN01000 Rev:001
Notification Date:	2/08/21
Last Buy Date:	Varies
Last Shipment Date	Varies

*** CONTINUED FROM PRIOR PAGE ***

*** All Plating types (PBFREE,TIN/LEAD) for each item listed are included in this notice.**

Central Part Number Replacement

Central would be happy to assist you by providing additional information or technical data to help locate an alternate source if we have no replacement available. Please email your requests to engineering@centrasemi.com.

DISCLAIMER: This End of Life (EOL) notification is in accordance with JEDEC standard JESD48 - Product Discontinuance. Central Semiconductor Corp. will make every effort to offer life-time buy (LTB) opportunities and/or offer replacement devices to existing customers for discontinued devices, however, one or both may not be possible for all devices. Please contact your local Central Semiconductor sales representative for LTB opportunities/additional information.