

# MAX7304PMB1 Peripheral Module

## General Description

The MAX7304PMB1 peripheral module provides the necessary hardware to interface the MAX7304 16-port GPIO and LED driver to any system that utilizes Pmod™-compatible expansion ports configurable for I<sup>2</sup>C communication. The IC features 16 GPIO ports with 12 push-pull GPIOs and four open-drain GPIOs configurable as PWM-controlled LED drivers. The device supports a 1.62V to 3.6V separate power supply for level translation. Each GPIO can be programmed to one of the two externally applied logic voltage levels. PORT12–PORT15 can also be configured as LED drivers that feature constant-current sinks and PWM intensity control with the internal oscillator. The maximum constant-current level for each open-drain LED port is 20mA. The intensity of the LED on each open-drain port can be individually adjusted through a 256-step PWM control. The port also features LED fading.

Refer to the MAX7304 IC data sheet for detailed information regarding operation of the IC.

*Ordering Information* appears at end of data sheet.

## Features

- ◆ Four LED Driver Pins on PORT12–PORT15
- ◆ 256-Step PWM Individual LED Intensity-Control Accuracy
- ◆ Individual LED Blink Rates and Common LED Fade-In/Out Rates
- ◆ Individually Programmable GPIOs to Two Logic Levels
- ◆ 8-Channel Individual Programmable Level Translators
- ◆ Configurable Edge-Triggered Port Interrupt
- ◆ Jumper-Selectable I<sup>2</sup>C Address Setting
- ◆ 6-Pin Pmod-Compatible Connector (I<sup>2</sup>C)
- ◆ Secondary Header Allows Daisy-Chaining of Additional Modules on I<sup>2</sup>C Bus
- ◆ Example Software Written in C for Portability
- ◆ RoHS Compliant
- ◆ Proven PCB Layout
- ◆ Fully Assembled and Tested

## MAX7304PMB1 Peripheral Module

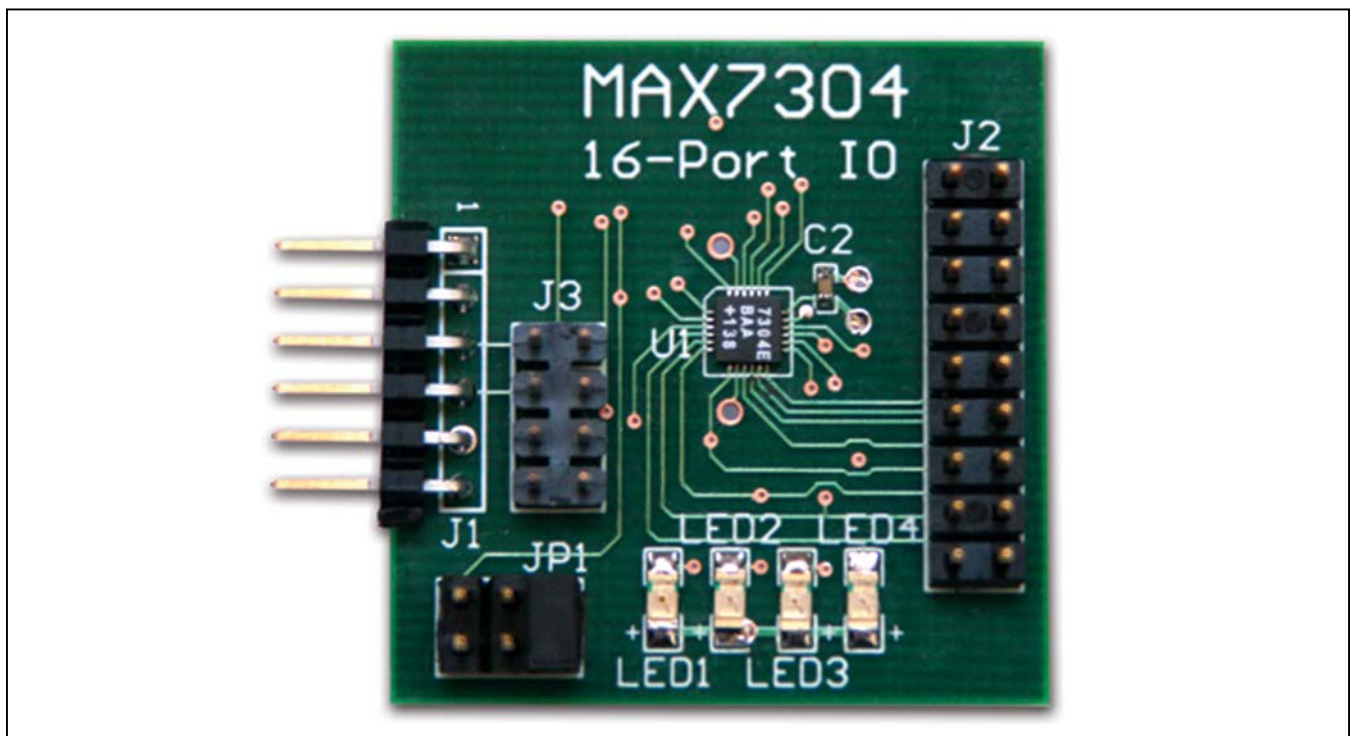

*Pmod is a trademark of Digilent Inc.*

For pricing, delivery, and ordering information, please contact Maxim Direct at 1-888-629-4642, or visit Maxim Integrated's website at [www.maximintegrated.com](http://www.maximintegrated.com).

# MAX7304PMB1 Peripheral Module

## Component List

DESIGNATION	QTY	DESCRIPTION
C1, C3	2	1 $\mu$ F $\pm$ 10%, 10V X7R ceramic capacitors (0603) TDK C1608X7R1A105K
C2	1	0.1 $\mu$ F $\pm$ 10%, 16V X7R ceramic capacitor (0603) Murata GRM188R71C104KA01D
J1	1	6-pin right-angle male header
J2	1	18-pin (2 x 9) straight male header
J3	1	8-pin (2 x 4) straight male header

DESIGNATION	QTY	DESCRIPTION
JP1	1	6-pin (2 x 3) straight male header
LED1-LED4	4	Red LEDs (1206)
R1, R2, R3	3	150 $\Omega$ $\pm$ 5% resistors (0603)
R4, R5	2	4.7k $\Omega$ $\pm$ 5% resistors (0603)
R6	1	10k $\Omega$ $\pm$ 5% resistor (0603)
U1	1	16-port, level-translating GPIO and LED driver (24 TQFN-EP*) Maxim MAX7304ETG+
—	1	Shorting jumper
—	1	PCB: EPCB7304PM1

\*EP = Exposed pad.

## Component Suppliers

SUPPLIER	PHONE	WEBSITE
Murata Electronics North America, Inc.	770-436-1300	www.murata-northamerica.com
TDK Corp.	847-803-6100	www.component.tdk.com

**Note:** Indicate that you are using the MAX7304PMB1 when contacting these component suppliers.

## Detailed Description

### UART Interface

The MAX7304PMB1 peripheral module can interface to the host by plugging directly into a Pmod-compatible port (configured for I<sup>2</sup>C) through connector J1. See Table 1.

The J2 connector provides the connection to the push-pull and open-drain outputs. See Table 2.

The J3 connector allows the module to be connected through a daisy-chain from another I<sup>2</sup>C module and/or provide I<sup>2</sup>C and power connections to other I<sup>2</sup>C modules on the same bus. See Table 3.

Jumper JP1 provides the ability to set the I<sup>2</sup>C address. This is accomplished by connecting the AD0 pin to GND, VCC, SDA, or SCL. See Table 4.

### Software and FPGA Code

Example software and drivers are available that execute directly without modification on several FPGA development boards that support an integrated or synthesized microprocessor. These boards include the Digilent Nexys 3, Avnet LX9, and Avnet ZEDBoard, although other platforms can be added over time. Maxim provides complete Xilinx ISE projects containing HDL, Platform Studio, and SDK projects. In addition, a synthesized bit stream, ready for FPGA download, is provided for the demonstration application.

**Table 1. Connector J1 (I<sup>2</sup>C Communication)**

PIN	SIGNAL	DESCRIPTION
1	N.C.	Not connected
2	INT	Interrupt
3	SCL	I <sup>2</sup> C serial clock
4	SDA	I <sup>2</sup> C serial data
5	GND	Ground
6	VCC	Power supply

The software project (for the SDK) contains several source files intended to accelerate customer evaluation and design. These include a base application (maximModules.c) that demonstrates module functionality and uses an API interface (maximDeviceSpecificUtilities.c) to set and access Maxim device functions within a specific module.

The source code is written in standard ANSI C format, and all API documentation including theory/operation, register description, and function prototypes are documented in the API interface file (maximDeviceSpecificUtilities.h & .c).

The complete software kit is available for download at [www.maximintegrated.com](http://www.maximintegrated.com). Quick start instructions are also available as a separate document.

# MAX7304PMB1 Peripheral Module

**Table 2. Connector J2**

PIN	SIGNAL	DESCRIPTION
1	P0	Push-pull output 0
2	P1	Push-pull output 1
3	P2	Push-pull output 2
4	P3	Push-pull output 3
5	P4	Push-pull output 4
6	P5	Push-pull output 5
7	P6	Push-pull output 6
8	P7	Push-pull output 7
9	P8	Push-pull output 8
10	P9	Push-pull output 9
11	P10	Push-pull output 10
12	P11	Push-pull output 11
13	P12	Output 12 (open-drain output 1)
14	P13	Output 13 (open-drain output 2)
15	P14	Output 14 (open-drain output 3)
16	P15	Output 15 (open-drain output 4)
17	VLA	Optional: User-applied VCC (refer to the MAX7304 IC data sheet for min/max limits before connecting external supply). If unused, leave unconnected.
18	GND	Ground

**Table 3. Connector J3 (Daisy-Chain I<sup>2</sup>C)**

PIN	SIGNAL	DESCRIPTION
1	SCL	I <sup>2</sup> C serial clock
2	SDA	I <sup>2</sup> C serial data
3	GND	Ground
4	VCC	Power supply
5	SCL	I <sup>2</sup> C serial clock
6	SDA	I <sup>2</sup> C serial data
7	GND	Ground
8	VCC	Power supply

**Table 4. Jumper JP1**

PIN	SIGNAL	DESCRIPTION
—	GND (AD0)	I <sup>2</sup> C address = 8'b0111 <b>00</b> 0x (x is 1 for read, x is 0 for write)
1-2	VCC (AD0)	I <sup>2</sup> C address = 8'b0111 <b>01</b> 0x (x is 1 for read, x is 0 for write)
3-4	SDA (AD0)	I <sup>2</sup> C address = 8'b0111 <b>10</b> 0x (x is 1 for read, x is 0 for write)
5-6	SCL (AD0)	I <sup>2</sup> C address = 8'b0111 <b>11</b> 0x (x is 1 for read, x is 0 for write)

# MAX7304PMB1 Peripheral Module

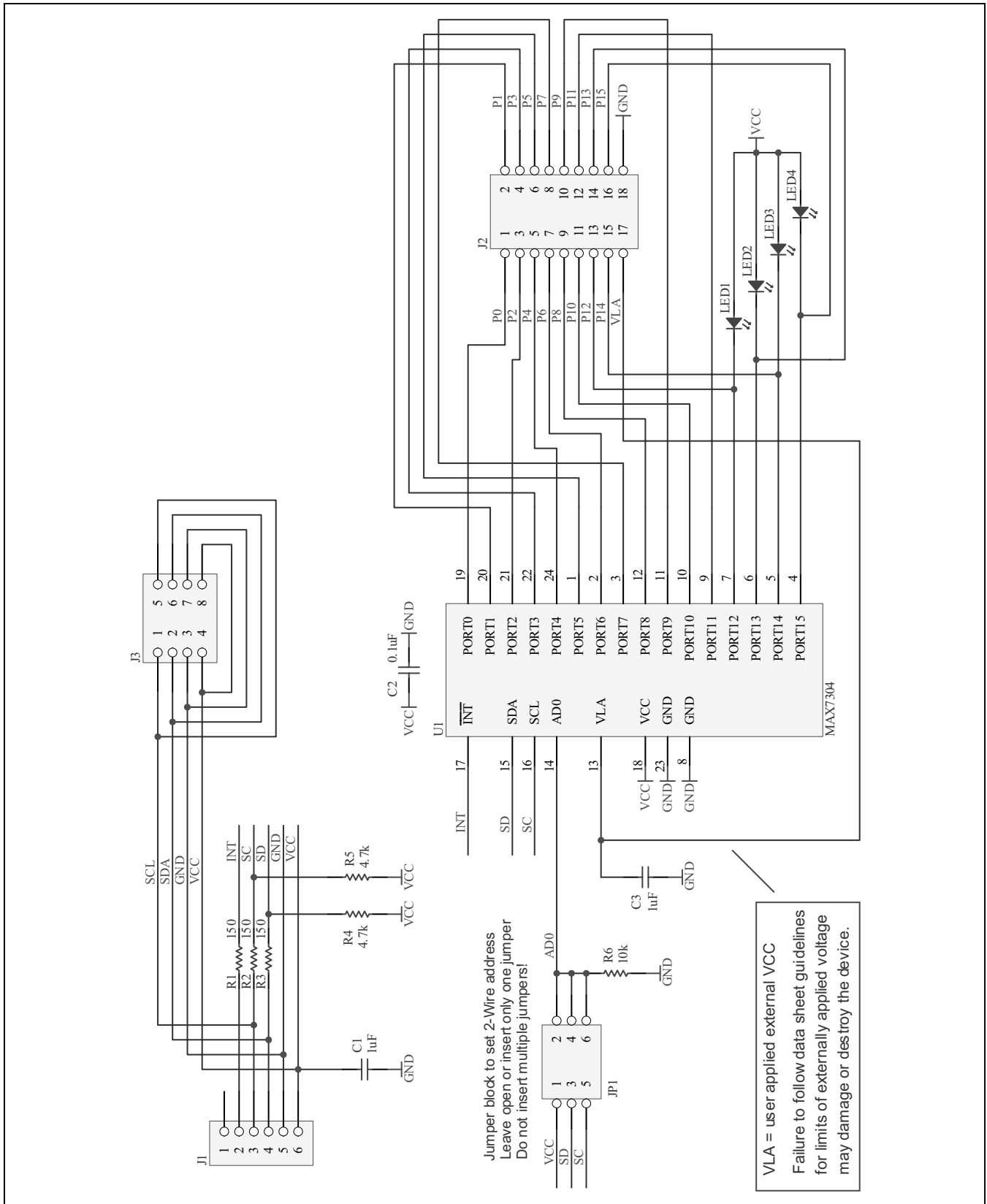

Figure 1. MAX7304PMB1 Peripheral Module Schematic

# MAX7304PMB1 Peripheral Module

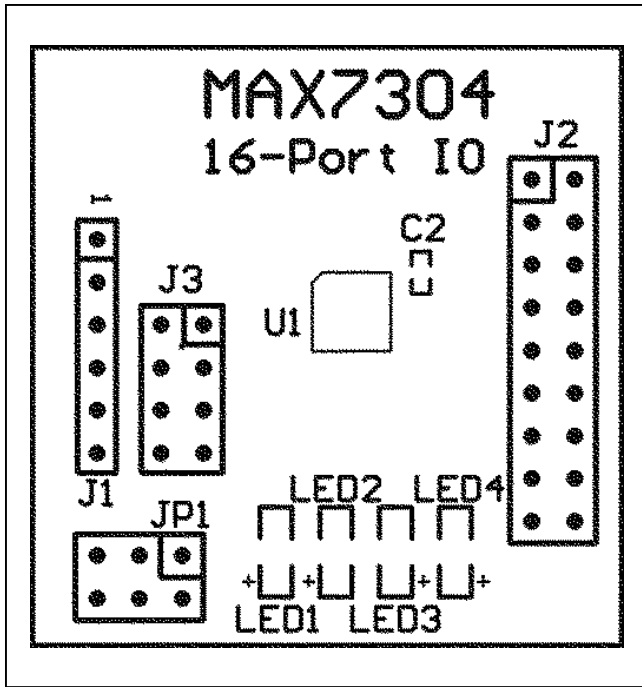

Figure 2. MAX7304PMB1 Peripheral Module Component Placement Guide—Component Side

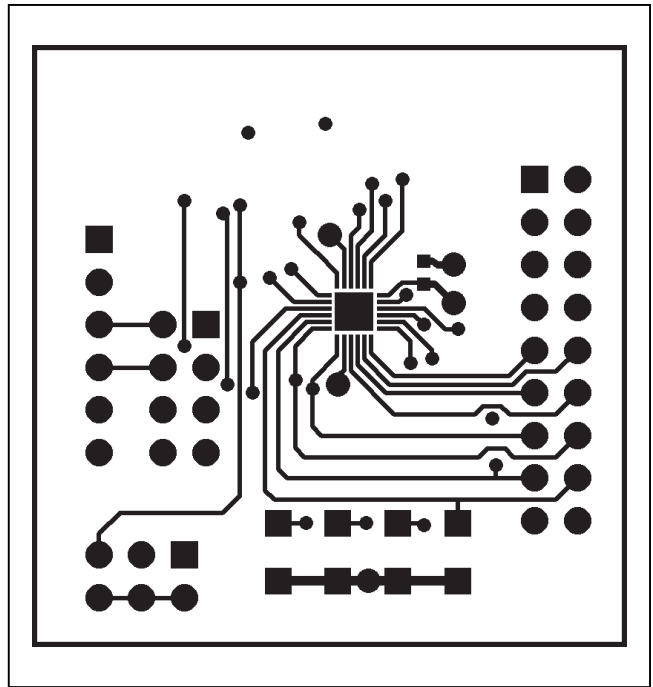

Figure 3. MAX7304PMB1 Peripheral Module PCB Layout—Component Side

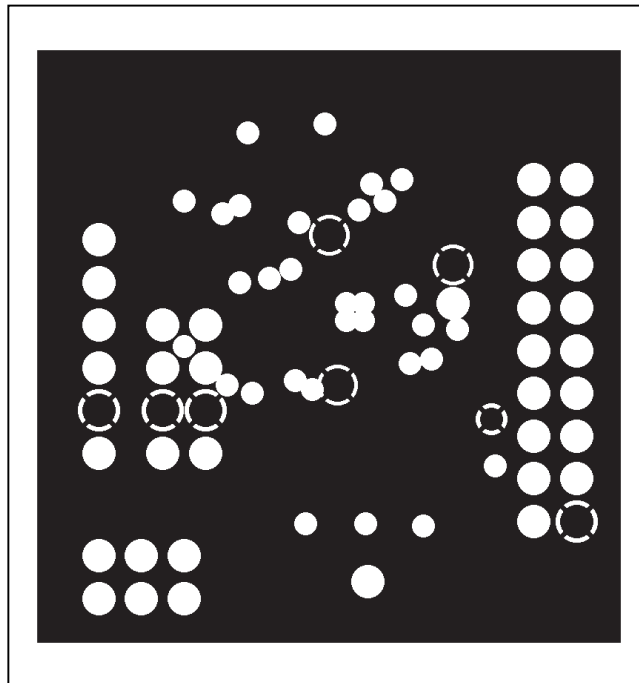

Figure 4. MAX7304PMB1 Peripheral Module PCB Layout—Inner Layer 1 (Ground)

# MAX7304PMB1 Peripheral Module

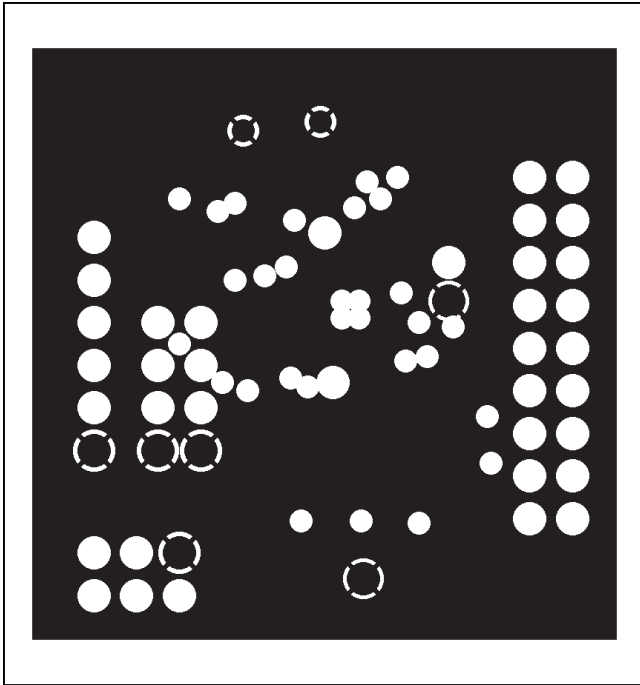

Figure 5. MAX7304PMB1 Peripheral Module PCB Layout—Inner Layer 2 (Power)

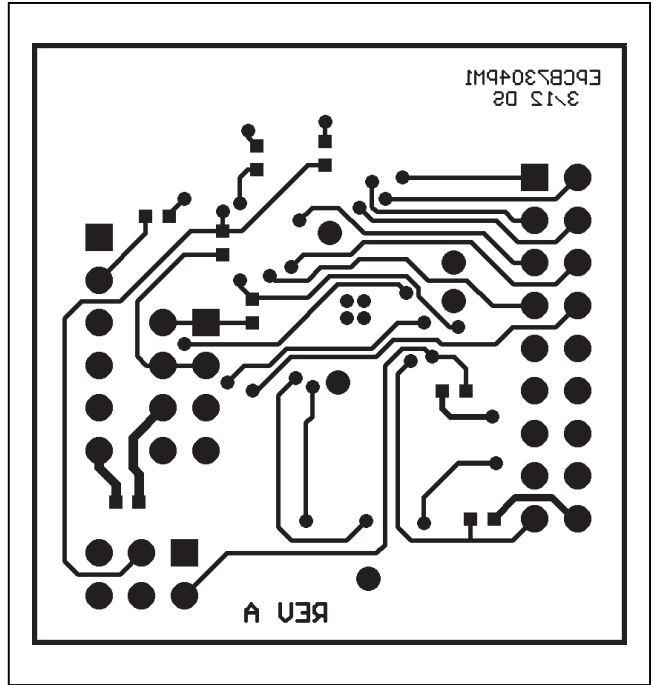

Figure 6. MAX7304PMB1 Peripheral Module PCB Layout—Solder Side

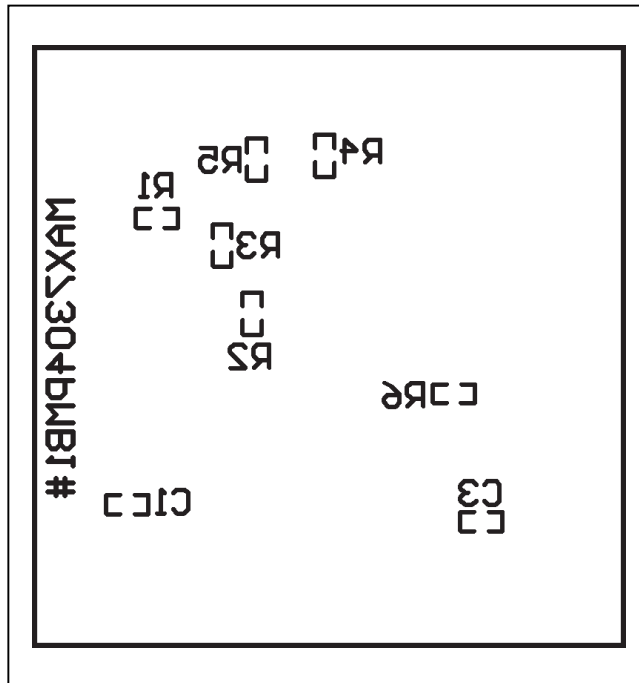

Figure 7. MAX7304PMB1 Peripheral Module Component Placement Guide—Solder Side

# MAX7304PMB1 Peripheral Module

## ***Ordering Information***

---

<b>PART</b>	<b>TYPE</b>
MAX7304PMB1#	Peripheral Module

#Denotes RoHS compliant.

# MAX7304PMB1 Peripheral Module

## Revision History

REVISION NUMBER	REVISION DATE	DESCRIPTION	PAGES CHANGED
0	5/12	Initial release	—



Maxim Integrated cannot assume responsibility for use of any circuitry other than circuitry entirely embodied in a Maxim Integrated product. No circuit patent licenses are implied. Maxim Integrated reserves the right to change the circuitry and specifications without notice at any time. The parametric values (min and max limits) shown in the Electrical Characteristics table are guaranteed. Other parametric values quoted in this data sheet are provided for guidance.

**Maxim Integrated 160 Rio Robles, San Jose, CA 95134 USA 1-408-601-1000**

8