

DO NOT SCALE FROM THIS PRINT

SERIES  
-24: 2.4mm

GENDER  
-P: PLUG

TYPE  
-C: CABLE

ORIENTATION  
-D: DIRECT SOLDER

ORIENTATION  
-S: STRAIGHT

CABLE TYPE  
-085: HARBOUR SS405

FINISH  
-EE: 50µ" EXTRA HEAVY GOLD  
CENTER CONTACT, 50µ" EXTRA  
HEAVY GOLD OUTER CONTACT

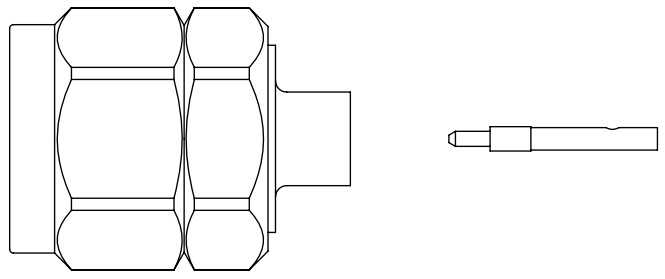
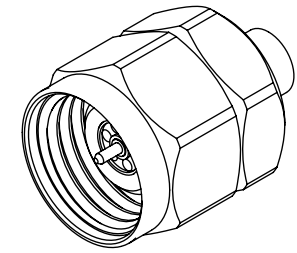
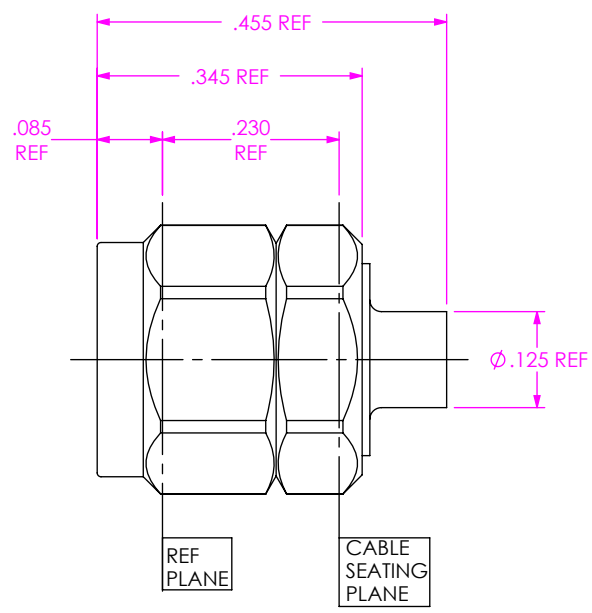

EXPLODED VIEW  
NOT TO SCALE  
(FOR CLARITY ONLY)

- NOTES:
- MATERIAL:  
COUPLING NUT: STAINLESS STEEL.  
GASKET: SILICONE RUBBER.  
BEAD: NORYL.  
BODY, CONTACT, LOCK RING: BERYLLIUM COPPER.
  - FINISH:  
COUPLING NUT: PASSIVATED.  
BODY, CONTACT: GOLD OVER NICKEL PLATE,  
50 µIN MIN GOLD OVER 50 µIN MIN NICKEL.
  - PCI PART NUMBER: 3203.

|  |   |   |
|--|---|---|
| UNLESS OTHERWISE SPECIFIED,<br>DIMENSIONS ARE IN INCHES.<br>TOLERANCES ARE:<br>DECIMALS                      ANGLES<br>.XX: ±.01                              1°<br>.XXX: ±.002<br>.XXXX: ±.0005 | * PROPRIETARY NOTE *<br>THIS DOCUMENT CONTAINS CONFIDENTIAL AND PROPRIETARY INFORMATION AND ALL DESIGN, MANUFACTURING, REPRODUCTION, USE, PATENT RIGHTS AND SALES RIGHTS ARE EXPRESSLY RESERVED BY SAMTEC, INC. THIS DOCUMENT SHALL NOT BE DISCLOSED, IN WHOLE OR PART, TO ANY UNAUTHORIZED PERSON OR ENTITY NOR REPRODUCED, TRANSFERRED OR INCORPORATED IN ANY OTHER PROJECT IN ANY MANNER WITHOUT THE EXPRESS WRITTEN CONSENT OF SAMTEC, INC. | <br>520 PARK EAST BLVD., NEW ALBANY, IN 47150<br>PHONE: 812-944-6733    FAX: 812-948-5047<br>e-Mail: info@SAMTEC.com    code 55322 |
|  |   | DESCRIPTION: 2.4MM PLUG DIRECT SOLDER TO HARBOUR SS405  |
|  |   | DWG. NO. PRF24-P-C-EE-085-SD<br>BY: CHRISTIAN S. 04/17/2019 SHEET 1 OF 2  |

1A. TRIM CABLE JACKET AND DIELECTRIC TO DIMENSION SHOWN.

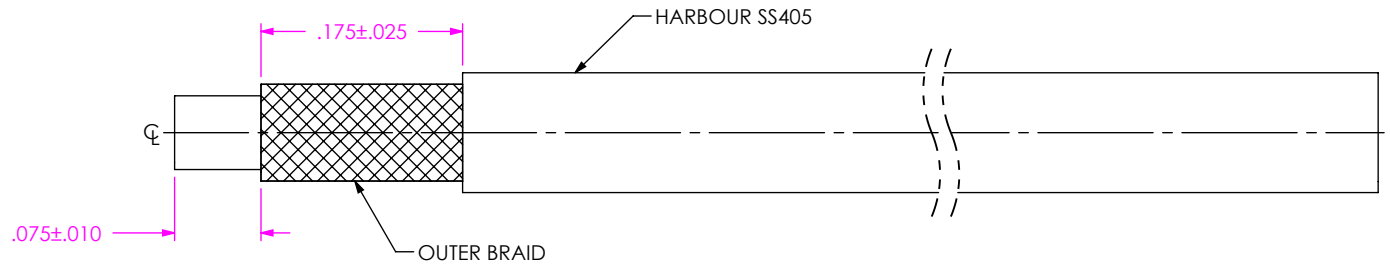

IN-PROCESS VIEW 1

2A. SOLDER CONTACT WITH GAP INDICATED

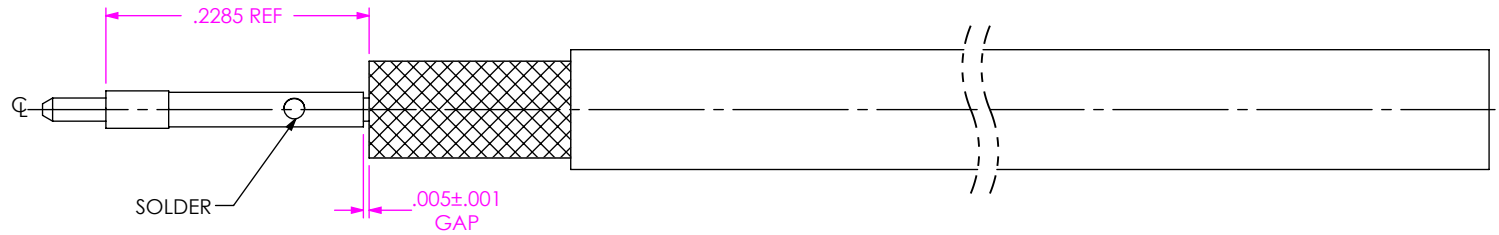

IN-PROCESS VIEW 2

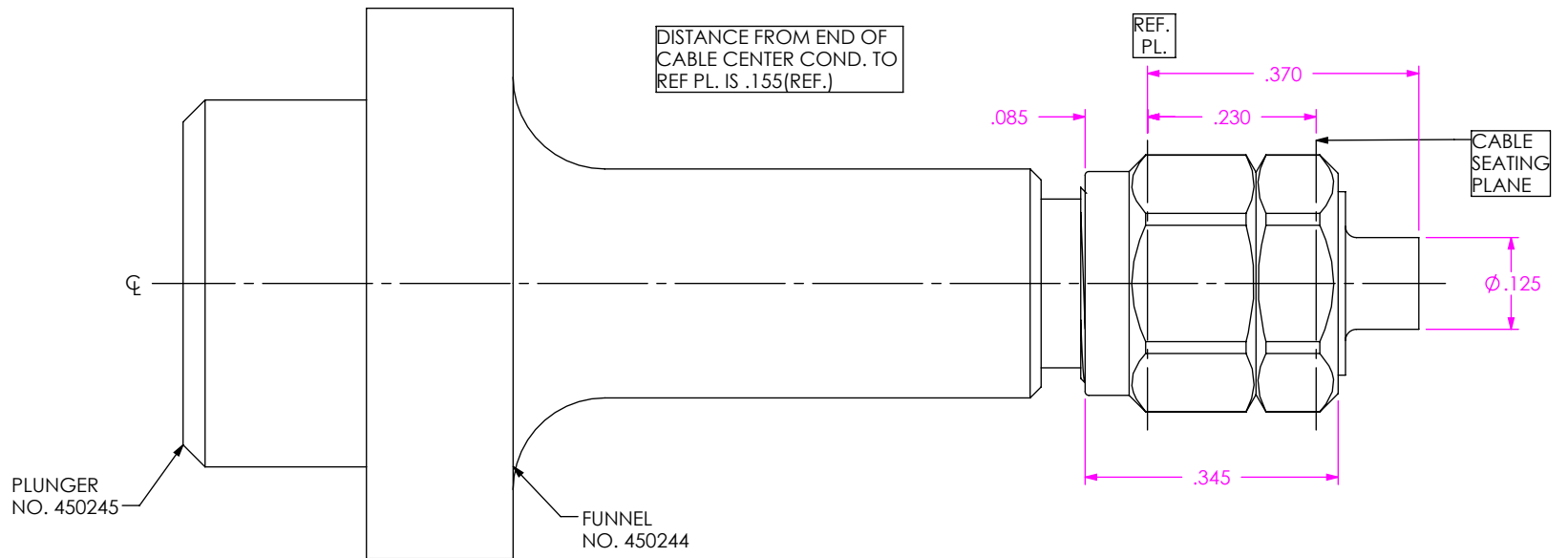

3A. INSERT CABLE/CONTACT UNTIL SETATED IN CONNECTOR AND SOLDER.  
 3B. INSTALL SUPPORT USING PCI FUNNEL NO. 450244 AND PLUNGER 450245(REF. 450246 TOOL KIT). BEAD SURFACE TO BE SUB- FLUSH TO REF. PLANE.  
 3C. INSPECT CONTACT RECESSION (.000/.003) USING APPROPRIATE GAGE.

IN-PROCESS VIEW 3

**PROPRIETARY NOTE**  
 THIS DOCUMENT CONTAINS CONFIDENTIAL AND PROPRIETARY INFORMATION AND ALL DESIGN, MANUFACTURING, REPRODUCTION, USE, PATENT RIGHTS AND SALES RIGHTS ARE EXPRESSLY RESERVED BY SAMTEC, INC. THIS DOCUMENT SHALL NOT BE DISCLOSED, IN WHOLE OR PART, TO ANY UNAUTHORIZED PERSON OR ENTITY NOR REPRODUCED, TRANSFERRED OR INCORPORATED IN ANY OTHER PROJECT IN ANY MANNER WITHOUT THE EXPRESS WRITTEN CONSENT OF SAMTEC, INC.



520 PARK EAST BLVD, NEW ALBANY, IN 47150  
 PHONE: 812-944-6733 FAX: 812-948-5047  
 e-Mail info@SAMTEC.com code 55322

DO NOT SCALE DRAWING

SHEET SCALE: 6:1

DESCRIPTION: 2.4MM PLUG DIRECT SOLDER TO HARBOUR SS405

DWG. NO. PRF24-P-C-EE-085-SD

BY: CHRISTIAN S. 04/17/2019 SHEET 2 OF 2