

AM1065 – Amplifier

DC to 8 GHz Bypassable

Description

The AM1065 is a high dynamic range bypassable DC-coupled amplifier covering up to 8 GHz. The device exhibits low bypass insertion loss and a moderate positive gain-slope, providing frequency equalization useful in many broadband applications. Packaged in a 4mm QFN or a shielded module with internal 50Ω matching and requiring a single positive control voltage, the AM1065 represents a dramatic size reduction over a discrete implementation of a bypassable amplifier.

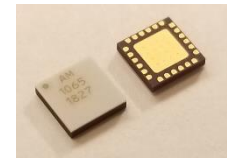

Features

- 20 dB Gain
- 2.0 dB Noise Figure
- +31 dBm OIP3
- +18 dBm P1dB
- +20 dBm PSat
- 1.25 dB Bypass Insertion Loss
- +5.0V, 72/1 mA (Gain/Bypass)
- +3.0V to +5.0V Supply Range
- +3.3V or +5V Logic Compatible
- 4mm QFN Package

Functional Diagram

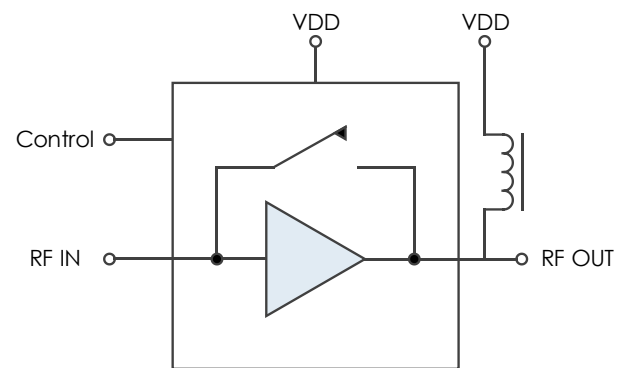

Characteristic Performance

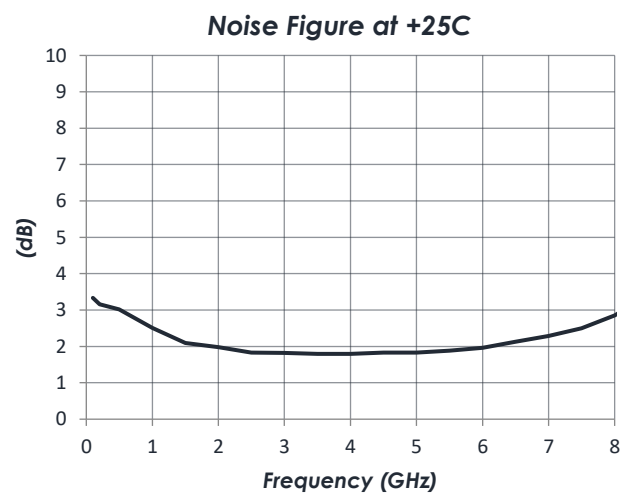
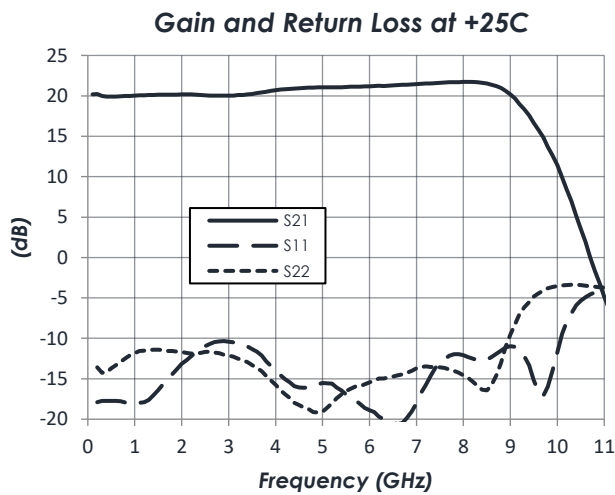

Table of Contents

Description	1	DC Electrical Characteristics	5
Features	1	RF Performance	5
Functional Diagram	1	State Table	5
Characteristic Performance	1	Timing Characteristics	6
Revision History	2	Typical Performance	7
Pin Layout and Definitions	3	Typical Application	10
Specifications	4	Part Ordering Details	11
Absolute Maximum Ratings	4	Related Parts	11
Handling Information	4	Evaluation PC Board	11
Recommended Operating Conditions	4	Component Compliance Information	12
Thermal Information	4		

Revision History

Date	Revision Number	Notes
April 24, 2018	7	Updated to new datasheet format and added more comprehensive data about part
July 16, 2018	8	C3 value in Typical Application updated. Max RF Input Power updated.
May 17, 2019	9	Additional Detail Added to Timing Section. Various Plots, Specifications, Typical Application, and Compliance Information Updated.
July 26, 2019	10	Added current draw in bypass mode. New RF shielded module available.
November 26, 2019	10A	Updated Description to include shielded module packaging
February 5, 2020	11	Updated module drawing with correct RF I/O labels
May 15, 2020	12	Package and module information moved to main product page
October 7, 2020	13	Control pin current drive level added. MSL corrected.

AM1065 – Amplifier

DC to 8 GHz Bypassable



Pin Layout and Definitions

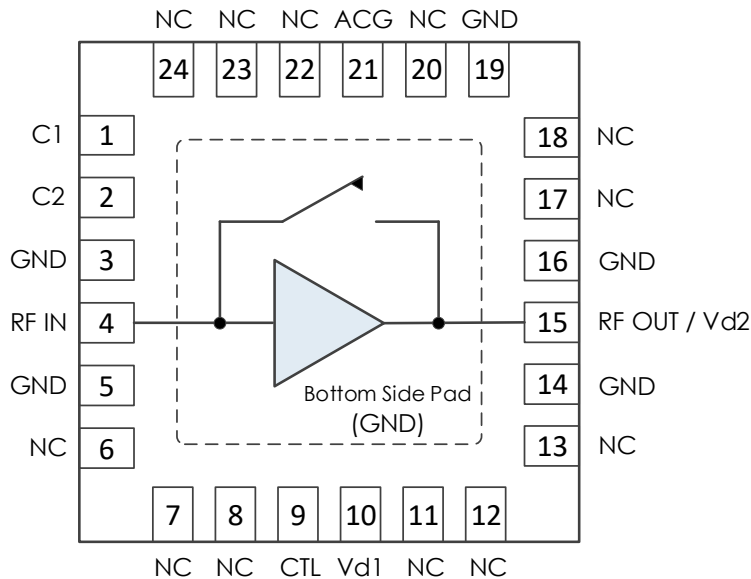

Pin Number	Pin Name	Pin Function
1	C1	External Capacitor Connection 1
2	C2	External Capacitor Connection 2
3	GND	Ground – Common
4	RF IN	RF Input – 50 ohms – DC Coupled, External DC Block Required
5	GND	Ground – Common
6-8	NC	Not Connected *
9	CTL	Bypass/Amplifier Mode Control
10	VD1	DC Power Input
11-13	NC	Not Connected *
14	GND	Ground – Common
15	RF OUT/VD2	RF Output and DC Power Input – 50 Ohms – DC Coupled, External DC Block Required.
16	GND	Ground – Common
17, 18	NC	Not Connected *
19	GND	Ground – Common
20	NC	Not Connected *
21	ACG	AC Ground
22-24	NC	Not Connected *
Bottom Pad	GND	Ground – Common

*NC pins may be grounded or left open

AM1065 – Amplifier

DC to 8 GHz Bypassable



Specifications

Absolute Maximum Ratings

	Minimum	Maximum
Supply Voltage	0.0 V	+6.0 V
RF Input Power		+25 dBm
Operating Junction Temperature	-40 C	+150 C
Storage Temperature Range	-50C	+150 C

Note: Any device operation beyond the Absolute Maximum Ratings may result in permanent damage to the device. The values listed in this table are extremes and do not imply functional operation of the device at these or any other conditions beyond what is listed under Recommended Operating Conditions. Any part subjected to conditions outside of what is recommended for an extended amount of time may suffer from reliability concerns.

Handling Information

	Minimum	Maximum
Storage Temperature Range (Recommended)	-50 C	+125 C
Moisture Sensitivity Level	MSL 1	



Atlanta Micro products are electrostatic sensitive.
Follow safe handling practices to avoid damage

Recommended Operating Conditions

	Minimum	Typical	Maximum
Supply Voltage	+3.0 V	+4.7 V	+5.2 V
Operating Case Temperature	-40 C		+85 C
Operating Junction Temperature	-40 C		+125 C

Thermal Information

	Thermal Resistance (°C / W)
Junction to Case Thermal Resistance (θ_{JC})	63.0

AM1065 – Amplifier

DC to 8 GHz Bypassable

DC Electrical Characteristics

(T = 25 °C unless otherwise specified)

Parameter	Testing Conditions	Minimum	Typical	Maximum
DC Supply Voltage		+3.0 V	+4.7 V	+5.2 V
DC Supply Current	VDD = +5.0 V, Amp On	64 mA	72 mA	80 mA
	VDD = +3.3 V, Amp On	28 mA	32 mA	36 mA
	VDD = +5.0 V, Amp Byp.		1 mA	
	VDD = +3.3 V, Amp Byp.		< 1mA	
Power Dissipated	VDD = +5.0 V, Amp On	0.32 W	0.36 W	0.40 W
	VDD = +3.3 V, Amp On	0.09 W	0.11 W	0.12 W
Logic Level Low		-0.1 V		+0.4 V
Logic Level High		+2.2 V		+VDD
Control Current	CTL = +3.3V		115 µA	
	CTL = +5.0V		200 µA	

RF Performance

(T = 25 °C unless otherwise specified)

Parameter	Testing Conditions	Minimum	Typical	Maximum
Frequency Range		DC		8 GHz
Gain	VDD = +5.0 V		20 dB	
	VDD = +3.3 V		19 dB	
Return Loss	VDD = +5.0 V		13 dB	
Bypass Insertion Loss	VDD = +5.0 V		1.25 dB	
Output IP3	VDD = +5.0 V		+31 dBm	
Output P1dB	VDD = +5.0 V		+18 dBm	
Noise Figure	VDD = +5.0 V		2.0 dB	

State Table

CTL	Amplifier
High	Enabled
Low	Bypassed

AM1065 – Amplifier

DC to 8 GHz Bypassable

Timing Characteristics

(T = 25 °C, VDD = +3.3V, CTL = 0.0V / +3.3V)

Switching Time	Minimum	Typical ²	Maximum
Amp On → Amp Bypass	125 ns	175 ns	300 ns
Amp Bypass → Amp On	700 ns	3.8 μs	7.0 μs

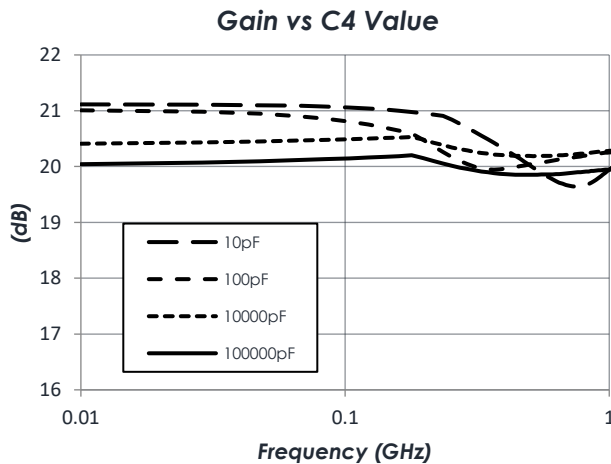
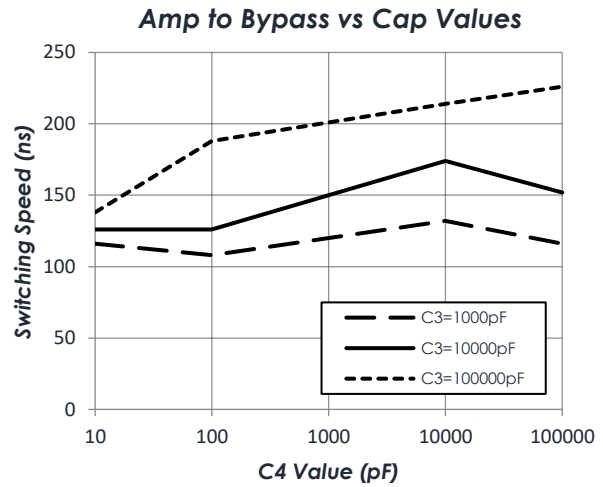
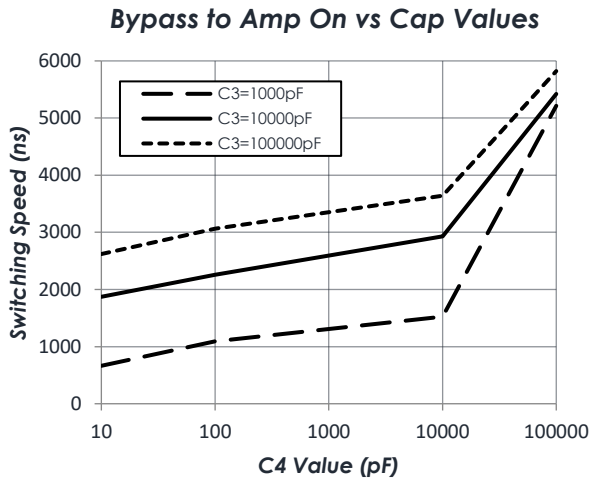

***Notes:**

1. Switching speeds measured as 50% trigger to 10%/90% RF respectively.
2. Typical measurements reflect switching speeds of amp as configured in Typical Application section.
3. To change times, alter value of C3 and C4 (see Typical Application section).

AM1065 – Amplifier

DC to 8 GHz Bypassable

Typical Performance

(Amplifier Enabled, VDD = +5.0 V, ID = 72mA)

Gain vs Temperature

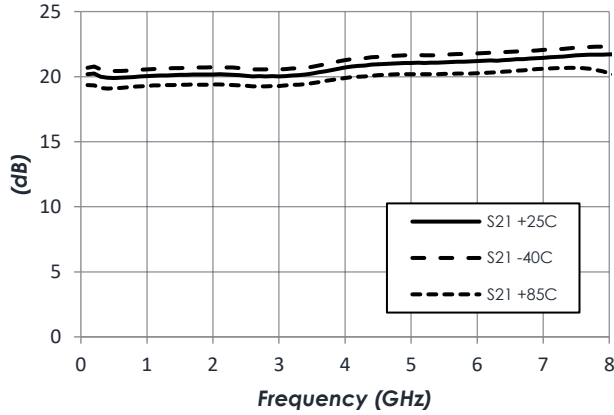

Noise Figure vs Temperature

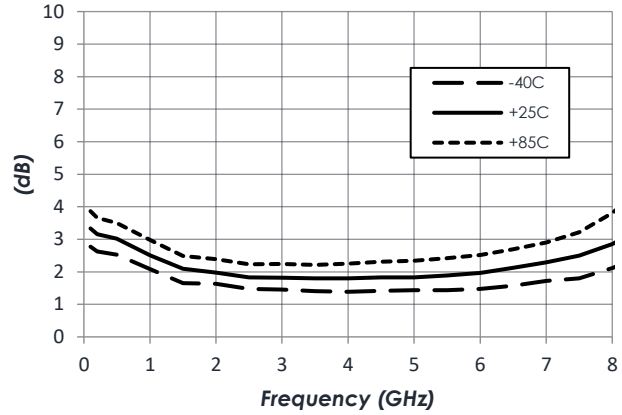

Output IP3 vs Temperature

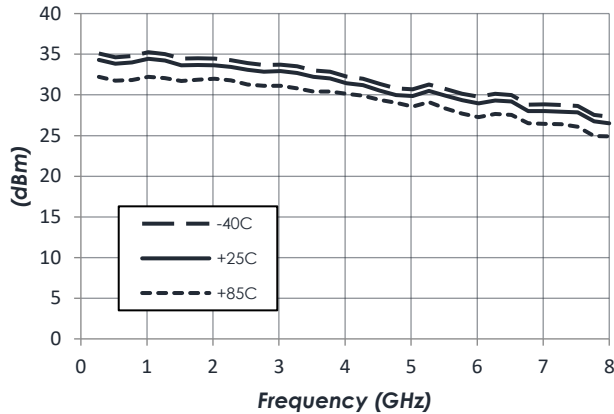

P1dB vs Temperature

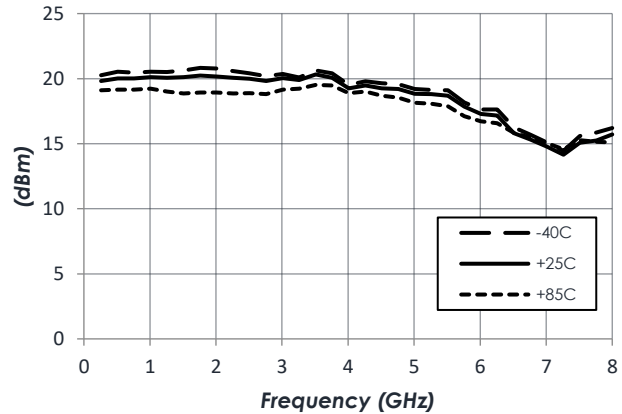

Reverse Isolation vs Temperature

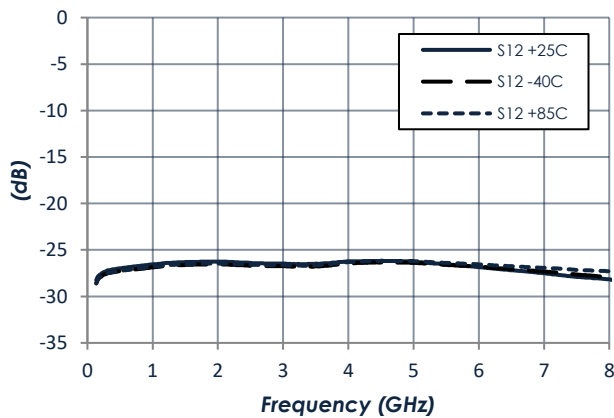

AM1065 – Amplifier

DC to 8 GHz Bypassable

Typical Performance (continued)

(Amplifier Enabled, VDD = +5.0 V, ID = 72mA)

P_{Sat} vs Temperature

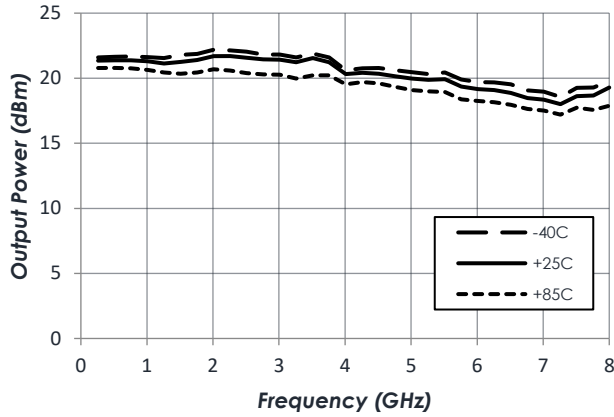

Pin vs. Pout at +25C

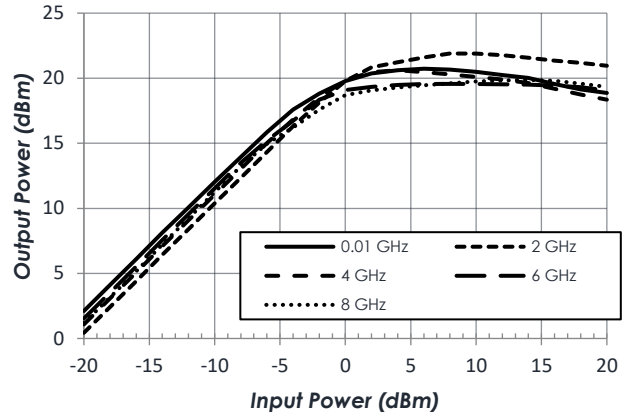

Pin vs. Pout at -40C

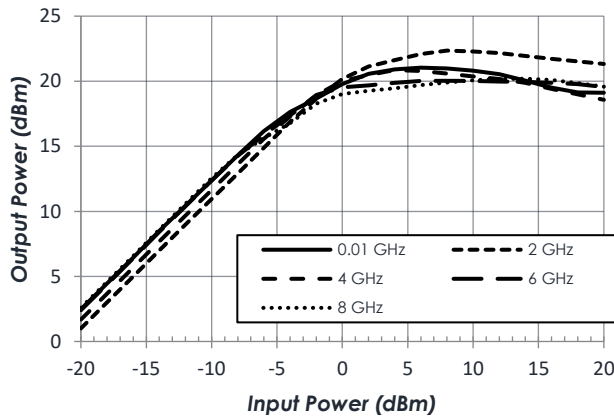

Pin vs. Pout at +85C

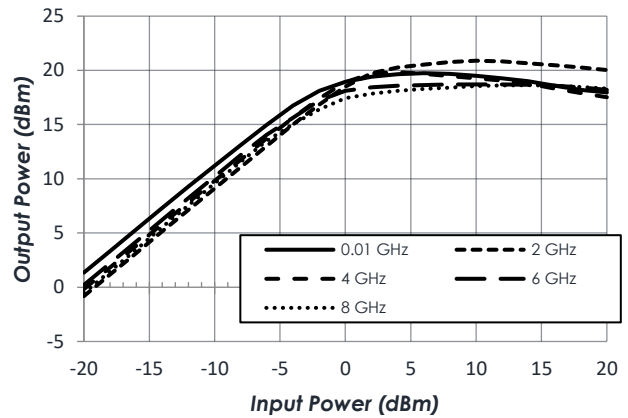

(Amplifier Bypass, VDD = +5.0 V, ID = 1mA)

Insertion and Return Loss at +25C

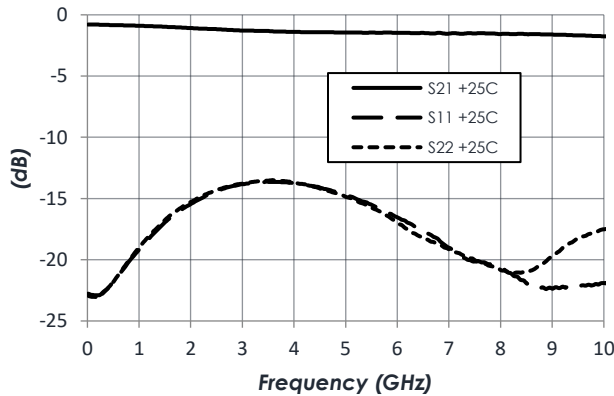

Insertion Loss vs Temperature

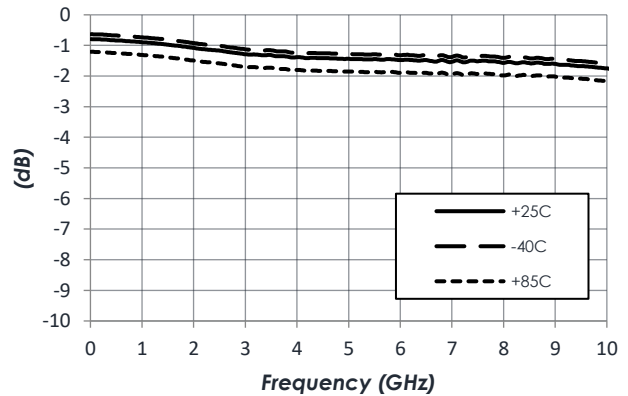

AM1065 – Amplifier

DC to 8 GHz Bypassable

Typical Performance (continued)

(T = 25 °C, Amplifier Enabled unless otherwise specified)

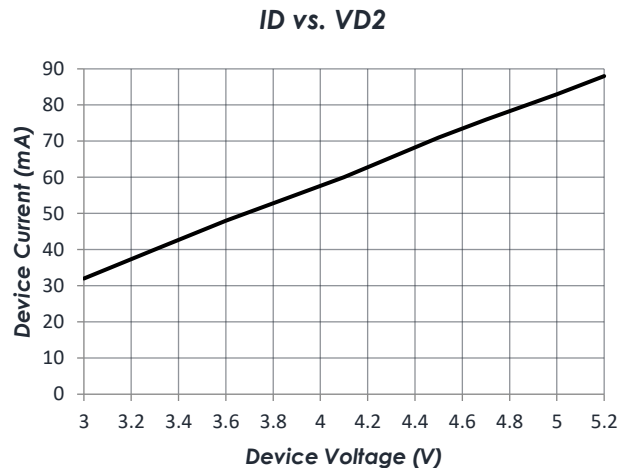
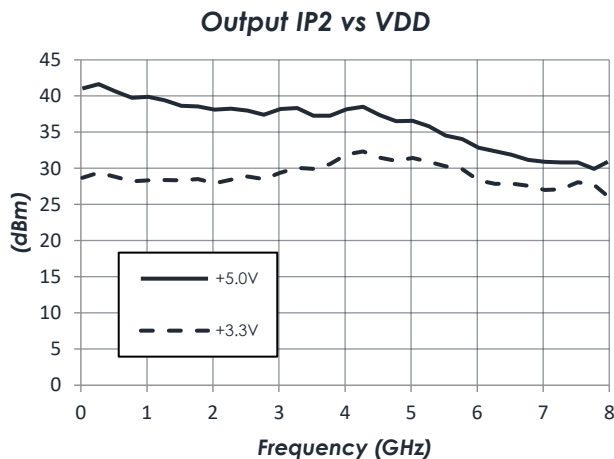
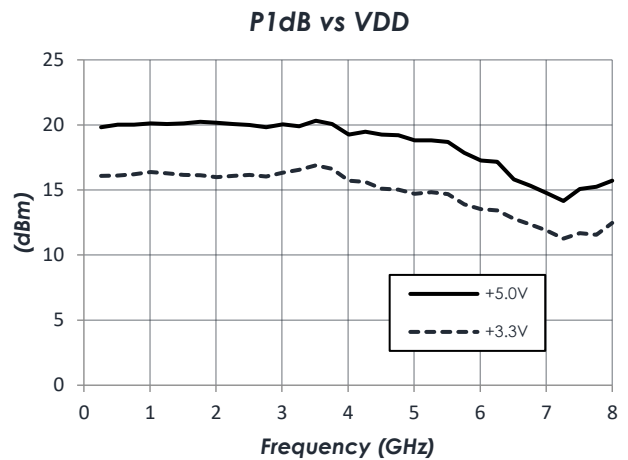
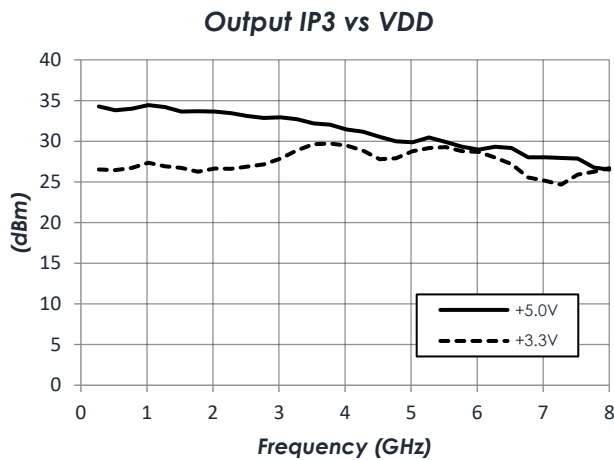
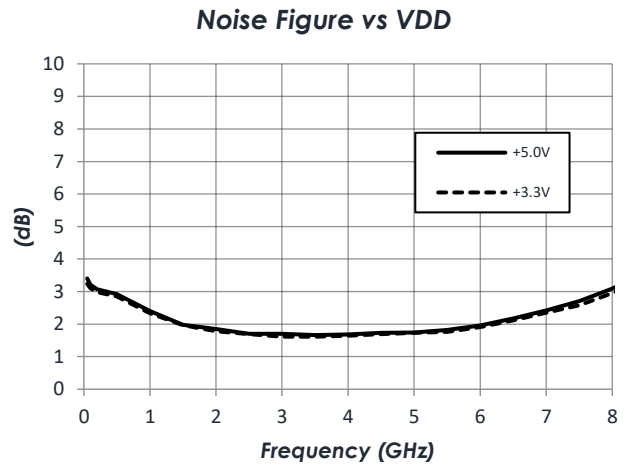
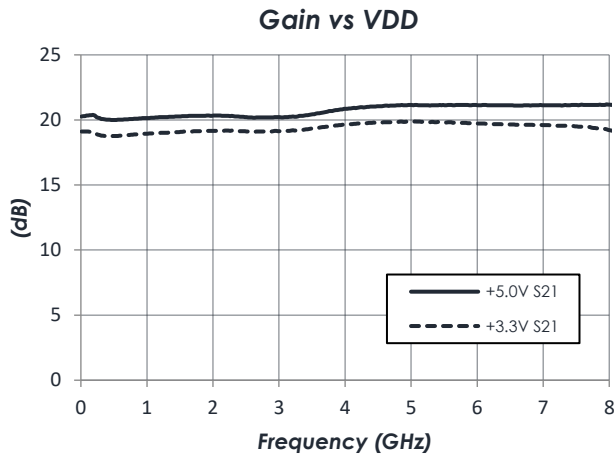

Typical Application

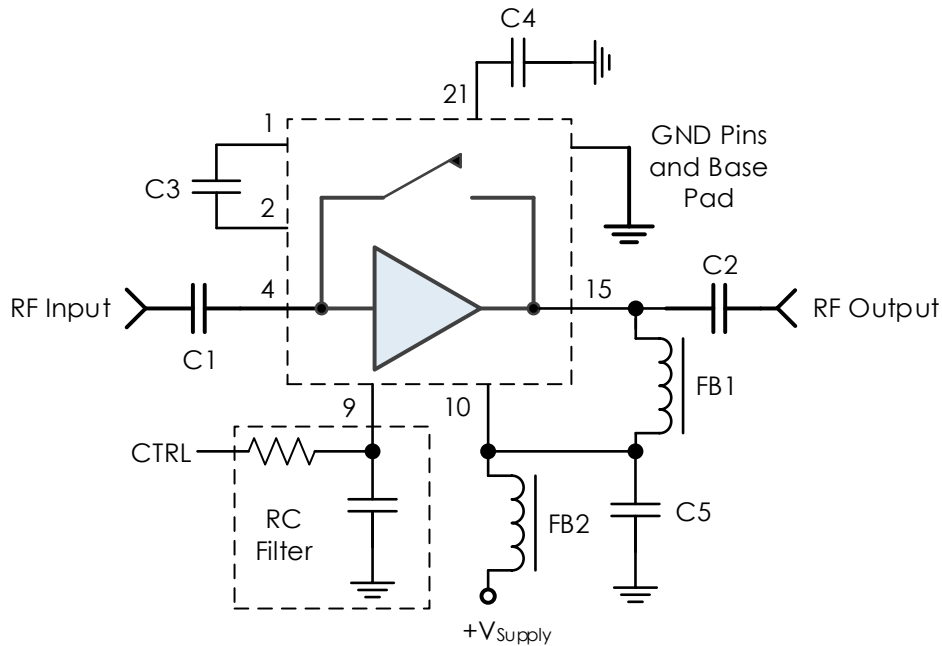

Recommended Component List (or equivalent):

Part	Value	Part Number	Manufacturer
C1, C2	0.1 μ F	0402BB104KW500	Passives Plus
C3	0.1 μ F	0201BB104KW250	Passives Plus
C4	10,000 pF	GRM033R61E103KA12D	Murata
C5	0.1 μ F	GCM155R71H104KE02J	Murata
FB1, FB2	-	MMZ1005A222E	TDK

Notes:

1. DC blocking capacitors C1 – C3 should be high performance, low-loss, broadband capacitors for optimum performance.
2. Select control line RC filter values based on desired logic source decoupling and switching speed
3. C3 and C4 should be placed as close to the AM1065 as possible to minimize PCB trace lengths. A 0201 package size is recommended to minimize stray PCB pad capacitance to ground.

AM1065 – Amplifier

DC to 8 GHz Bypassable



Part Ordering Details

Description	Part Number
4mm 24 Lead QFN	AM1065
AM1065 Evaluation Board	AM1065 Eval
AM1065 in 0.95" x 1.13" x 0.6" RF-Shielded Module with Integrated Bias Tee and Field Replaceable SMA Connectors	AM1065-M

Related Parts

Part Number	Description
AM1063-1	DC to 10 GHz Gain Block
AM1063-2	DC to 10 GHz Miniature Gain Block
AM1064-1	DC to 8 GHz Gain Block
AM1064-2	DC to 8 GHz Miniature Gain Block
AM1067	5 GHz to 20 GHz Bypassable Gain Block
AM1073	DC to 8 GHz Bidirectional / Bypassable Gain Block
AM1075	5 GHz to 26.5 GHz Bypassable Gain Block
AM1077	5 GHz to 20 GHz Bypassable Gain Block w/ Isolation State
AM1081	DC to 8 GHz Bypassable Gain Block (Higher IP3)

Evaluation PC Board

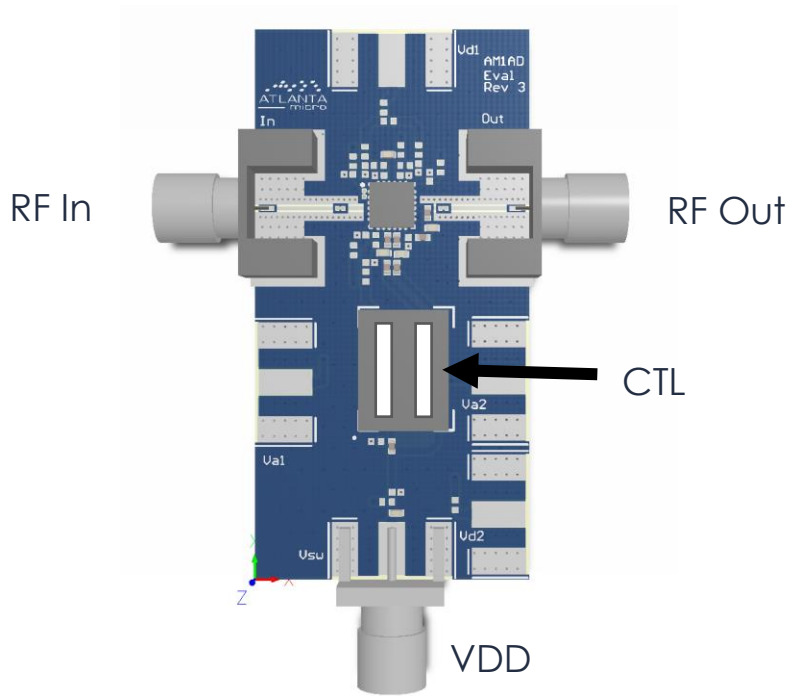

To obtain price, delivery, or to place an order contact sales@atlantamicro.com
 Atlanta Micro Inc., 3720 Davinci Ct, Suite 125, Peachtree Corners, GA 30092 • Phone: (470) 253-7640 • www.atlantamicro.com

Component Compliance Information

RoHS: Atlanta Micro, Inc. hereby certifies that all products comply with the EC Directive 2011/65/EC on the Restriction of Hazardous Substances, commonly known as EU-RoHS 6 and 10. All products supplied by Atlanta Micro shall be compliant with the European Directive 2011/65/EC based on the following substance list.

Substance List	Allowable Maximum Concentration
Lead (Pb)	<1000 PPM (0.1% by weight)
Mercury (Hg)	<1000 PPM (0.1% by weight)
Cadmium (Cd)	<75 PPM (0.0075% by weight)
Hexavalent Chromium (CrVI)	<1000 PPM (0.1% by weight)
Polybrominated Biphenyls (PBB)	<1000 PPM (0.1% by weight)
Polybrominated Diphenyl ethers (PBDE)	<1000 PPM (0.1% by weight)
Decabromodiphenyl Deca BDE	<1000 PPM (0.1% by weight)
Bis (2-ethylhexyl) Phthalate (DEHP)	<1000 PPM (0.1% by weight)
Butyl Benzyl Phthalate (BBP)	<1000 PPM (0.1% by weight)
Dibutyl Phthalate (DBP)	<1000 PPM (0.1% by weight)
Diisobutyl Phthalate (DIBP)	<1000 PPM (0.1% by weight)

REACH: Atlanta Micro, Inc. neither uses nor intentionally adds any of the substances considered to be a Substance of Very High Concern (SVHC) as defined by the EU Regulation (EC) No. 1907-2006 on Registration, Evaluation, Authorization, and Restriction of Chemicals (REACH).

Conflict Materials: Atlanta Micro does not knowingly use materials that are sourced from the Democratic Republic of Congo (DRC) or any other known conflict regions. Atlanta Micro's supply chain is comprised of sources that are both environmentally and socially responsible. We periodically review this requirement with our vendors to ensure continued compliance.

Atlanta Micro takes its responsibility as a global partner seriously and will use due diligence within our supply chain to ensure all standards are met to the best of our knowledge.