

## Evaluation Board for the **ADAS3023** 16-Bit, 8-Channel, Simultaneous Sampling Data Acquisition System

### FEATURES

- Full-featured evaluation board for the **ADAS3023**
- Versatile analog signal conditioning circuitry
- On-board reference, clock oscillator, and buffers
- Converter evaluation and development board (**EVAL-CED1Z**) compatible
- PC software for control and data analysis (time and frequency domain)

### KIT CONTENTS

**EVAL-ADAS3023EDZ** evaluation board

### ADDITIONAL EQUIPMENT NEEDED

- EVAL-CED1Z** board
- Precision signal source
- World-compatible 7 V dc supply (enclosed with **EVAL-CED1Z**)
- USB cable

### EVALUATION BOARD DESCRIPTION

The **EVAL-ADAS3023EDZ** is an evaluation board for the **ADAS3023** 16-bit data acquisition system (DAS). This device integrates an 8-channel low leakage track and hold, a high impedance programmable gain instrumentation amplifier (PGIA) stage with high common-mode rejection, a precision 16-bit successive approximation (no latency) analog-to-digital

converter, and precision 4.096 V reference. It is capable of converting two channels simultaneously up to 500,000 samples per second (500 kSPS) throughput.

The evaluation board is designed to demonstrate the performance of the **ADAS3023** and to provide an easy-to-understand interface for a variety of system applications. A full description of this product is available in the product data sheet and should be consulted when utilizing this evaluation board.

The evaluation board is intended to be used with the Analog Devices, Inc., converter evaluation and development (CED) board, **EVAL-CED1Z**, a USB-based capture board connected to P4, the 96-pin interface.

On-board components include a high precision, buffered band gap 4.096 V reference (**ADR434**), a reference buffer (**AD8032**), passive signal conditioning circuitry, and an FPGA for deserializing the serial conversion results and configuring the **ADAS3023** via a 4-wire serial interface.

The P3 connector allows users to test their own interface with or without the optional Altera FPGA, U6 (programmed using the P2 and passive serial EEPROM, U5).

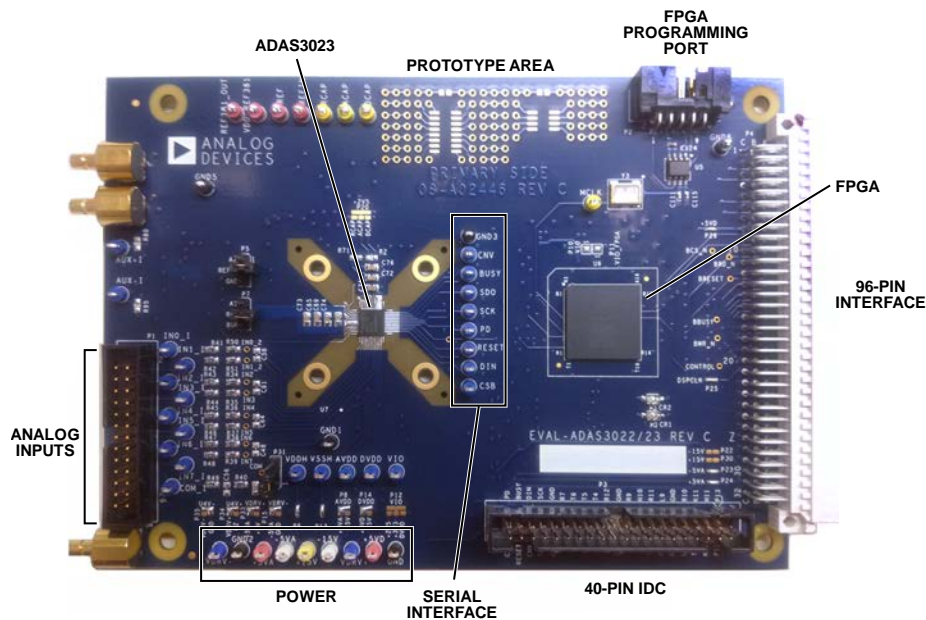

Figure 1. **EVAL-ADAS3023EDZ** Evaluation Board

## TABLE OF CONTENTS

Features ..... 1

Kit Contents..... 1

Additional Equipment Needed ..... 1

Evaluation Board Description..... 1

Revision History ..... 2

Evaluation Board Hardware ..... 3

    Overview..... 3

    Device Description..... 3

    Jumpers, Solder Pads, and Test Points ..... 3

    Analog Interface ..... 3

    FPGA..... 4

    Reference ..... 4

    Evaluation Board Schematics/PCB Layout ..... 5

    Basic Hardware Setup ..... 5

    Jumpers and Test Points .....6

Evaluation Board Software .....8

    Software Installation .....8

    Powering Up the Board ..... 11

    Running the Software with the Hardware Connected ..... 11

    Software Operation ..... 12

    Time Domain Tab ..... 16

    Histogram Tab ..... 17

    Spectrum Tab ..... 18

    Summary Tab ..... 19

Evaluation Board Schematics and Artwork ..... 20

Products on this Evaluation Board ..... 28

    Bill of Materials ..... 28

Related Links ..... 30

## REVISION HISTORY

### 9/14—Rev. A to Rev. B

Reorganized Layout..... Throughout

Changes to Reference Section ..... 4

Changes to Basic Hardware Setup Section ..... 5

Changes to Software Installation Section, System Requirements Section, and Website Download Section ..... 8

Replaced Figure 4 ..... 8

Added Figure 5, Figure 6, and Figure 7, Renumbered Sequentially ..... 8

Removed USB Drivers Section ..... 8

Added Figure 8 to Figure 13..... 9

Changes to Running the Software with the Hardware Connected Section..... 11

Removed AC Testing Section.....

Changes to Software Operation Section..... 12

Added File Menu (Label 1) Section, Edit Menu (Label 2) Section, Help Menu (Label 3) Section, Throughput (Label 4) Section, Samples (Label 5) Section, Single Capture (Label 6) and Continuous Capture (Label 7) Section, and Tabs Section. 12

Removed Configuring the ADAS3023 Device Section, Channel Pairing Section, Figure 11, Figure 12, and Figure 13; Renumbered Sequentially..... 12

Changes to Figure 18 ..... 13

Added Figure 19..... 13

Added Figure 20 to Figure 22 ..... 14

Added Figure 23..... 15

Removed Histogram Display Section, Time Domain Display Section, Figure 15, and Figure 16 ..... 14

Changes to Start Up Section and Input Channel Section, Programmable Gain Section, and Software Controls Section..... 15

Added Time Domain Tab Section and Figure 24 ..... 16

Changes to Histogram Tab Section and Figure 25..... 17

Added DC Testing Section and AC Testing Section..... 17

Changes to Spectrum Tab Section and Figure 26 ..... 18

Changes to Summary Tab Section and Figure 27 ..... 19

Changes to Related Links Section ..... 30

### 5/13—Rev. 0 to Rev. A

Changes to Title and Evaluation Board Description Section .....1

Changes to Device Description Section .....3

Removed CD-ROM Section .....8

Changes to Running the Software with the Hardware Connected Section ..... 10

Changes to Figure 10 and Changes to Start Up Section..... 11

Changes to Figure 14..... 13

Changes to Figure 16..... 14

Changes to Figure 17..... 15

Changes to Figure 18..... 16

Changes to Figure 19..... 17

### 4/13—Revision 0: Initial Version

## EVALUATION BOARD HARDWARE

### OVERVIEW

The EVAL-ADAS3023EDZ evaluation board is designed to offer simple evaluation of this integrated device. From a block diagram perspective, the board uses a set of analog input test points (or an IDC header), some passive footprints for RC filtering and external reference, the ADAS3023 device, a serial interface to the on-board FPGA, and power that can be supplied locally or via EVAL-CED1Z or externally. Note that the ADAS3023 device also has an on-chip reference; however, external circuitry is provided for those who need to test other suitable options.

The small prototyping area can be useful for building additional circuitry, if desired. Each block has a specific function as defined in the following sections.

### DEVICE DESCRIPTION

Manufactured using the Analog Devices patented high voltage iCMOS® process, the ADAS3023 is a complete data acquisition system (DAS) on a single chip that is capable of converting two channels simultaneously up to 500 kSPS. This part allows the differential voltage range up to  $\pm 20.48$  V when using  $\pm 15$  V supplies. The ADAS3023 can resolve the full-scale differential voltages of  $\pm 2.56$  V,  $\pm 5.12$  V,  $\pm 10.24$  V, and  $\pm 20.48$  V, and it can be configured to sample two, four, six, or eight channels simultaneously.

The key difference between the ADAS3022 and ADAS3023 is that the ADAS3023 does not offer the AUX $\pm$  channels and temperature sensor (using the CFG register). In addition, the BUSY/SDO2 (Pin 19) functionality of the ADAS3023 is different.

The ADAS3022/ADAS3023 devices become pin compatible and can be exchanged on the same footprint if the no connect (NC) pins (Pin 14/Pin 29/Pin 30 on the ADAS3022) and AUX $\pm$  (Pin 5 and Pin 40 on the ADAS3022) are tied to AGND, and if the SDO2 (using the CFG register) of the ADAS3023 is not enabled, so that the user can actually work with either one of these options using the same evaluation board. Leaving these pins floating is not recommended. Note that the differential paired mode does not exist in the ADAS3023 and, therefore, its 2/4/6/8 channels are always referenced to COM.

The ADAS3023 is an ideal replacement for a typical 16-bit, simultaneous sampling precision data acquisition system that simplifies the design challenges by eliminating signal buffering, level shifting, amplification/attenuation, common-mode rejection, settling time, or any of the other analog signal conditioning challenges while allowing smaller form factor, faster time to market, and lower costs.

Data communication to and from the ADAS3023 occurs asynchronously without any pipeline delay using a common 4-wire serial interface compatible with SPI, FPGA, and DSP.

A rising edge on CNV samples the differential analog inputs of a channel or channel pair. The ADAS3023 configuration register allows the user to configure the number of enabled channels, the differential input voltage range, and the interface mode using the evaluation board and software as detailed in this user guide. Complete specifications for the ADAS3023 are provided in the product data sheet and should be consulted in conjunction with this user guide when using the evaluation board. Full details on the EVAL-CED1Z are available on the Analog Devices website.

**Table 1. Typical Input Range Selection**

Single-Ended Signals <sup>1</sup>	Input Range, VIN (V)
0V to 1V	$\pm 1.28$ V
0V to 2.5V	$\pm 2.56$ V
0V to 5V	$\pm 5.12$ V
0V to 10V	$\pm 10.24$ V

<sup>1</sup> See the ADAS3023 data sheet for more information

### JUMPERS, SOLDER PADS, AND TEST POINTS

Numerous solder pads and test points are provided on the evaluation board and are detailed fully in Table 4, Table 5, and Table 6. Note the nomenclature for this evaluation board for a signal that is also connected to an IDC connector would be signal\_I. The two 3-pin user selectable jumpers are used for the ADCs reference selection and are fully described in the Reference section.

### ANALOG INTERFACE

The analog interface is provided with test points for each of the analog inputs IN[7:0] and COM (that is, IN0\_I is common to both the test point and to P1). The passive device footprints can be used for filtering, if desired. A simple RC filter made up of 22  $\Omega$  and 2700 pF NPO capacitors is provided. Note that the use of stable dielectric capacitors, such as NPO or COG, is required in the analog signal path to preserve the ADAS3023 distortion. Using X5R or other capacitors in the analog signal path greatly reduces the performance of the system. Also, note that many bench top arbitrary waveform generators (AWGs) use 12-bit or 14-bit digital-to-analog converter outputs such that the 16-bit ADAS3023 devices digitize this directly resulting in erroneous looking data. If such an AWG is used, a high-order band-pass filter should be used to filter the unwanted noise from these sources.

The P31 center pin is connected to the ADAS3023 COM input, which can be routed to P1 or GND using P31. For channel -to-COM configuration, set the jumper across Pin 1 and Pin 2 to route to P1. For channel pairs configuration, set the jumper across Pin 2 to Pin 3 to route to GND. This is useful for single-ended applications.

For dynamic performance, an FFT test can be done by applying a very low distortion ac source, such as an Audio Precision System 2702. This source can be set for balanced or unbalanced, and can be floated or grounded depending on the user's choice.

## FPGA

The on-board FPGA performs a number of digital functions, one of them being the sample rate conversion controlled using the software. Another function is deserializing the serial conversion results as the CED data capture board uses a 16-bit parallel interface. If desired, the deserialized data can be monitored on the 96-pin edge connector P1, BD[15:0]. The CED uses a buffered busy signal, BBUSY, as the general interrupt for the data transfer to the CED board.

The FPGA also provides the necessary [ADAS3023](#) asynchronous control signals for RESET and power down (PD).

The signals from the FPGA to the [ADAS3023](#) can be bypassed by modifying the default solder pad connections. As shown in Figure 2, each digital signal on the [ADAS3023](#) is connected to the larger (top) pad of the three. The default configuration is the small pad and larger pad (no text) which connects the FPGA to the [ADAS3023](#) (CNV, BUSY, and SDO signals shown). The labeled pads, CNV\_I, BUSY\_I, SDO\_I, and so on, are the signals that are routed to P3. To use P3 instead of the FPGA, unsolder the default connections and resolder from the large pad to the xxx\_I pads. The FPGA will remain powered; however, if all the signals are bypassed in this fashion, it will not have any influence on the [ADAS3023](#).

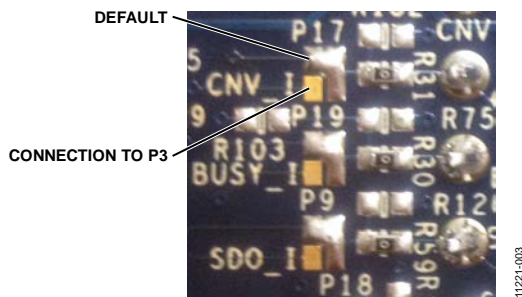

Figure 2. Digital Interface Solder Pads—Partial View

## Serial Interface

The 4-wire serial interface consisting of  $\overline{CS}$ , DIN, SCK, and SDO is present on the digital interface test points and is controlled by the FPGA. The FPGA can be bypassed by using the solder pads.

## REFERENCE

The [ADAS3023](#) has an internal 4.096 V reference, along with an internal buffer, useful for using an external reference or one can use an external 4.096 V reference directly, such as the [ADR434](#) provided on the evaluation board. The evaluation board can be configured to use any of these references. Two jumpers (P5 and P7) are used for setting the reference in conjunction with software control.

### External Reference—Factory Configuration

The evaluation board includes the [ADR434](#), A1, which is a 4.096 V precision voltage reference. This reference can drive the ADC REF1 or REF2 (REFx) pin directly or it can also be

buffered with U20, the [AD8032](#); both of these are set to the factory default setting.

Table 2. Factory Reference Jumper Configuration

Jumper	Setting
P5	REFIN to GND <sup>1</sup>
P9	REF to BUF (U20)

<sup>1</sup>The connection is made through R102 = 10 k to GND.

To use another reference source, there are two methods:

- For an external unbuffered reference, remove the P9 jumper and connect a source to the REF test point.
- Since the [ADR434](#) is a standard 8-lead SOIC, it can also be removed and replaced with the user's reference. In this case, the user reference and the U20 [AD8032](#) buffer can be used as a reference source.

### Internal 4.096 V Reference

The ADC has an internal 4.096 V precision reference and can be used on most applications. When enabled, 4.096 V will be present on the [ADAS3023](#) REFx pin and test point, REF. In addition, a voltage will also be present on the [ADAS3023](#) REFIN pin and test point, REFIN. The voltage present on REFIN can be used for other purposes, such as to provide the bias voltage; however, it would need a suitable buffer as the output impedance of the REFIN is on the order of a few kilo ohms and loading this voltage down will degrade the internal reference's performance.

Table 3. Internal Reference Jumper Configuration

Jumper	Setting
P5	Open
P9	Open

Note that the [ADAS3023](#) configuration register needs to be updated either using the included software or by writing the appropriate bits to enable the internal reference.

### Internal Reference Buffer

The internal reference buffer is useful when using an external 2.5 V reference. When using the internal reference buffer, applying 2.5 V to REFIN, which is directly connected to the ADC's REFIN pin, produces 4.096 V at the ADCs REFx pin and REF test point.

## POWER SUPPLIES AND GROUNDING

The on-board [ADP3334](#) low dropout regulators are provided for 2.5 V, 3.3 V, and 5 V and also for the FPGA I/O supply which is user configurable and set to 3.3 V by default. The FPGA core is supplied by a pair of [ADP1715](#) devices set for 1.2 V. Additional power is supplied via the CED board for an alternative +5 V analog and digital 3.3 V/5 V digital through P4.

The [ADAS3023](#) requires  $\pm 15$  V supplies for VDDH and VSSH. These must be supplied by the user using a standard lab supply ensuring that the return paths are at the same potential. Refer to [CN-0201](#) for the complete information on generating these  $\pm 15$  V supplies from a +5 V single supply. The differential input common-mode voltage (VCM) range changes according to the maximum input range selected and the high voltage power supplies (VDDH and VSSH). In other words, the specified operating input voltage of any input pin requires 2.5 V of headroom from the VDDH and VSSH supplies.

The evaluation board ground plane consists of a solid plane on one PCB layer shared on another layer with the power plane. To attain high-resolution performance, the board was designed to ensure that all digital ground return paths do not cross the analog ground return paths, that is, all analog on one side and digital on the other.

### EVALUATION BOARD SCHEMATICS/PCB LAYOUT

The evaluation board is a 6-layer board carefully laid out and tested to demonstrate the specific high accuracy performance of the [ADAS3023](#) devices. The Evaluation Board Schematics and Artwork section of this user guide shows the schematics of the evaluation board.

### BASIC HARDWARE SETUP

The [ADAS3023](#) evaluation board connects to the [EVAL-CED1Z](#) converter evaluation and demonstration board. The [EVAL-CED1Z](#) board is the controller board, which is the communication link between the PC and the main evaluation board.

Figure 3 shows a photograph of the connections made between the [ADAS3023](#) daughter board and the [EVAL-CED1Z](#) board.

1. Before connecting power, ensure that the [EVAL-ADAS3023EDZ](#) and the [EVAL-CED1Z](#) boards are connected firmly together.
2. Connect the power supplies on the [EVAL-ADAS3023EDZ](#) board. The [EVAL-ADAS3023EDZ](#) requires external power supplies of  $\pm 15$  V. Connect them from a bench top power supply.
3. Connect the [EVAL-CED1Z](#) board to the PC via the USB cable enclosed in the [EVAL-CED1Z](#) kit. If using a Windows® XP platform, you may need to search for the [EVAL-CED1Z](#) drivers. Choose to automatically search for the drivers for the [EVAL-CED1Z](#) board if prompted by the operating system.
4. Proceed to the Software Installation section to install the software. Note that the [EVAL-CED1Z](#) board must not be connected to the PC's USB port until the software is installed. The 7 V dc supply can be connected, however, to check that the board has power (green LED lit).

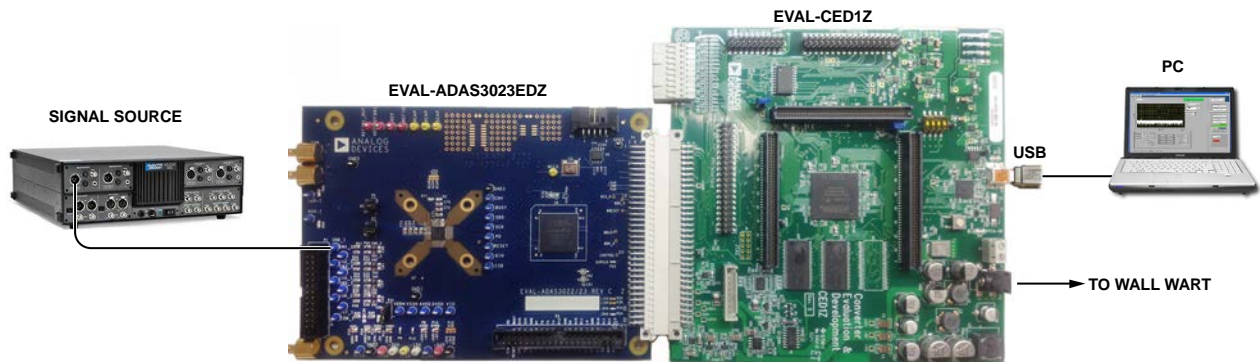

Figure 3. Hardware Configuration—Setting Up the [EVAL-ADAS3023EDZ](#)

112Z-002

## JUMPERS AND TEST POINTS

Three-pin jumpers are used to configure the ADC reference. Refer to the Reference section for further details and settings.

**Table 4. Pin Jumper Descriptions**

Jumper	Default	Function
P5	REFIN to GND	<p>REFIN Select. Buffered reference input selection. Use in conjunction with P7. Note that the <a href="#">ADAS3023</a> REFx pin and any other circuit traces/test points will produce 4.096 V when using the buffered reference configuration; P7 must be left in the open position.</p> <p>REFIN to A2: Uses the on-board <a href="#">ADR381</a>, A2 (2.5 V) reference. The <a href="#">ADAS3023</a> must use the buffered reference configuration.</p> <p>REFIN to GND: Disables the <a href="#">ADAS3023</a> internal reference. The <a href="#">ADAS3023</a> must use the full external reference configuration.</p> <p>Open: For use either when using the <a href="#">ADAS3023</a> on-chip reference or when applying an external 2.5 V source. When using the on chip reference, a voltage is present on Pin 2 and any other circuit traces/test points. When using an external source, the <a href="#">ADAS3023</a> must use the buffered reference configuration.</p>
P7	REF to BUF	<p>REF Select. External 4.096 V reference input selection. Use in conjunction with P5. Note that the <a href="#">ADAS3023</a> REFIN pin and any other circuit traces/test points produce 2.5 V when using the internal or external reference configuration and P5 must be left in the open position.</p> <p>REF to A1: Uses the on-board <a href="#">ADR434</a>, A1 (4.096 V), reference. The <a href="#">ADAS3023</a> must use the external reference configuration.</p> <p>REF to BUF: Uses the on-board <a href="#">ADR434</a> followed by the <a href="#">AD8032</a>, U20 unity gain buffer. This allows some adjustment to the reference voltage by use of some resistors around the <a href="#">AD8032</a>. The <a href="#">ADAS3023</a> must use the external reference configuration.</p> <p>Open: For use when using the <a href="#">ADAS3023</a> on-chip reference or an externally applied source connected directly to Pin 2 or the REF test point.</p>
P31	COM to PIN 1	<p>COM Input Select. Center pin connected to <a href="#">ADAS3023</a> COM pin. Center pin to PIN1 routes COM to P1. Center to PIN3 routes COM to GND.</p>

Solder pads jumpers are factory configured and can be changed by the user.

**Table 5. Analog and Digital Solder Pads Descriptions**

Jumper	Name	Default	Function
P9	SDO	1 to 3	SDO Interface Select. Pad 1 to Pad 3 for FPGA; Pad 2 to Pad 3 for P3 to P34.
P16	DIN	1 to 3	DIN Interface Select. Pad 1 to Pad 3 for FPGA; Pad 2 to Pad 3 for P3 to P35.
P17	CNV	1 to 3	CNV Interface Select. Pad 1 to Pad 3 for FPGA; Pad 2 to Pad 3 for P3 to P36.
P18	SCK	1 to 3	SCK Interface Select. Pad 1 to Pad 3 for FPGA; Pad 2 to Pad 3 for P3 to P33.
P19	BUSY	1 to 3	BUSY Interface Select. Pad 1 to Pad 3 for FPGA; Pad 2 to Pad 3 for P3 to P37.
P27	RESET	1 to 3	RESET Interface Select. Pad 1 to Pad 3 for FPGA; Pad 2 to Pad 3 for P3 to P38.
P28	PD	1 to 3	PD Interface Select. Pad 1 to Pad 3 for FPGA; Pad 2 to Pad 3 for P3 to P39.
P29	$\overline{\text{CS}}$	1 to 3	$\overline{\text{CS}}$ Interface Select. Pad 1 to Pad 3 for FPGA; Pad 2 to Pad 3 for P3 to P40.
P25	DSPCLK	Soldered	CED Clock Source.

**Table 6. Power Supply Solder Pads**

Jumper	Name	Default	Function
P6	VDDH	Soldered	VDDH Supply.
P13	VSSH	Soldered	VSSH Supply.
P8	AVDD	+5VA	AVDD Supply. Selection of +5 V A, analog supply from the CED board or +5 V from U3.
P10	–	Soldered	VIO Supply. This solder pad can be used to power the FPGA VIO and <a href="#">ADAS3023</a> VIO together.
P11	–	Soldered	FPGA VIO Supply. Supplied from U8, 3.3 V, dedicated digital supply.
P12	VIO	Open	VIO Supply. Selection of 2.5 V (2V5), 3.3 V (3V3), or DVDD (5V). Note that the <a href="#">ADAS3023</a> digital outputs are set to this level and are directly wired to the FPGA, U6, which is 3.3 V max. When using the 5 V setting, the <a href="#">ADAS3023</a> outputs, SDO and BUSY must be resistively divided using the 0603 pads provided on the evaluation board. For this reason, P10 is used as the default.
P14	DVDD	+5VD	DVDD Supply. Selection of +5 V digital, +5 V D, and +5 V from U3.
P15	VDRV-	-5VA	U20 V-/P34 Supply. Selection of -5 V A, analog supply from the CED board or GND.
P33	VDRV+	+5VA	U20 V+/P35 Supply. Selection of +5 V A, analog supply from the CED board or +5 V from U3.
P34	U4 V+	VDRV+	U4 V+ Supply. Selection of VDRV+ or U2.
P35	U4 V-	VDRV-	U4 V- Supply. Selection of VDRV- or GND.
P22	-15V	Soldered	-15 V CED Supply.
P23	-5VA	Soldered	-5 V A (Analog) CED Supply.
P24	+5VA	Soldered	+5 V A (Analog) CED Supply.
P26	+5VD	Soldered	+5 V D (Digital) CED Supply.
P30	+15V	Soldered	+15 V (Analog) CED Supply.

**Table 7. Test Points (By Signal Type)**

Test Point	Type	Description
IN0_I	Analog Input	Path for IN0 Input.
IN1_I	Analog Input	Path for IN1 Input.
IN2_I	Analog Input	Path for IN2 Input.
IN3_I	Analog Input	Path for IN3 Input.
IN4_I	Analog Input	Path for IN4 Input.
IN5_I	Analog Input	Path for IN5 Input.
IN6_I	Analog Input	Path for IN6 Input.
IN7_I	Analog Input	Path for IN7 Input.
COM_I	Analog Input	Path for COM Input.
REF	Analog Input	Direct Connection to <a href="#">ADAS3023</a> REFx Pin.
REFIN	Analog Input	Direct Connection to <a href="#">ADAS3023</a> REFIN Pin.
CNV	Digital Input	Direct Connection to <a href="#">ADAS3023</a> CNV Pin.
BUSY	Digital Output	Direct Connection to <a href="#">ADAS3023</a> BUSY Pin.
SDO	Digital Output	Direct Connection to <a href="#">ADAS3023</a> SDO Pin.
SCK	Digital Input	Direct Connection to <a href="#">ADAS3023</a> SCK Pin.
PD	Digital Input	Direct Connection to <a href="#">ADAS3023</a> PD Pin.
RESET	Digital Input	Direct Connection to <a href="#">ADAS3023</a> RESET Pin.
DIN	Digital Input	Direct Connection to <a href="#">ADAS3023</a> DIN Pin.
CSB	Digital Input	Direct Connection to <a href="#">ADAS3023</a> $\overline{CS}$ Pin.
MSCL	Digital Output	Eval Board Master Clock Form Y3, 100 MHz Oscillator.
VDDH	Power	Direct Connection to <a href="#">ADAS3023</a> VDDH Pin.
VSSH	Power	Direct Connection to <a href="#">ADAS3023</a> VSSH Pin.
AVDD	Power	Direct Connection to <a href="#">ADAS3023</a> AVDD Pin.
DVDD	Power	Direct Connection to <a href="#">ADAS3023</a> DVDD Pin.
VIO	Power	Direct Connection to <a href="#">ADAS3023</a> VIO Pin.
+5VA	Power	Connected to P24; CED +5 V A.
-5VA	Power	Connected to P23; CED -5 V A.
+15V	Power	Connected to P30; CED +5 V A.
-15V	Power	Connected to P22; CED -5 V A.
+5VD	Power	Connected to P26; CED +5 V D.
GND(s)	Power	Connected to Eval Board GND Plane.

# EVALUATION BOARD SOFTWARE

## SOFTWARE INSTALLATION

Close major Windows applications prior to installing the software.

### System Requirements

- Windows® XP (SP2, 32-bit), Windows Vista® (32-bit or 64-bit), or Windows 7 (32-bit or 64-bit)
- USB 2.0 (for CED board)
- Administrator privileges

### Website Download

The evaluation board software is available for download from the evaluation board page on Analog Devices website. Click the **setup.exe** file to run the install. The default location for the software is **C:\Program Files (x86)\Analog Devices\ADAS3023 Evaluation Software**.

To ensure that the evaluation system is correctly recognized when connected to the PC, install the evaluation software before connecting the evaluation board and the **EVAL-CED1Z** board to the USB port of the PC.

There are two portions of the software installation process:

- **ADAS3023** evaluation board software installation
- **EVAL-CED1Z** board driver installation

Figure 4 to Figure 9 show the separate steps to install the **ADAS3023** evaluation software. Figure 10 to Figure 12 show the separate steps to install the **EVAL-CED1Z** drivers.

Proceed through all of the installation steps to allow the software and drivers to be placed in the appropriate locations.

Only connect the **EVAL-CED1Z** board to the PC after the software and drivers are installed.

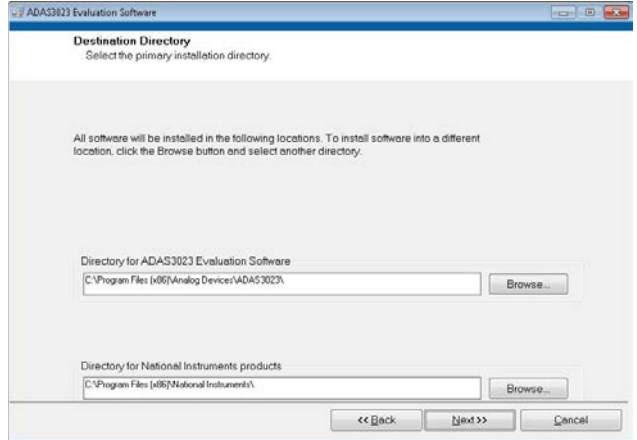

Figure 5. ADAS3023 Evaluation Software Destination Directory



Figure 6. ADAS3023 Evaluation Software License Agreement

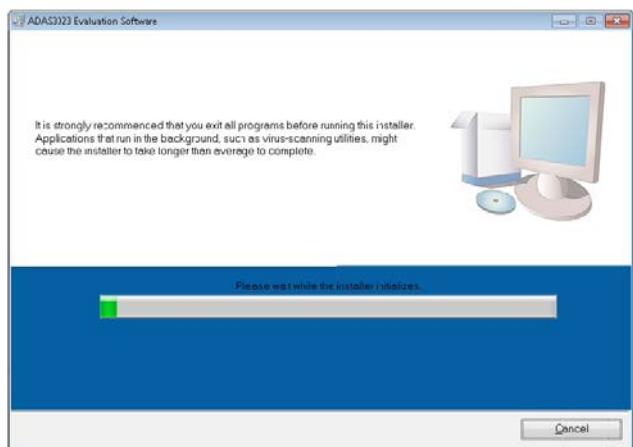

Figure 4. ADAS3023 Evaluation Software Installer

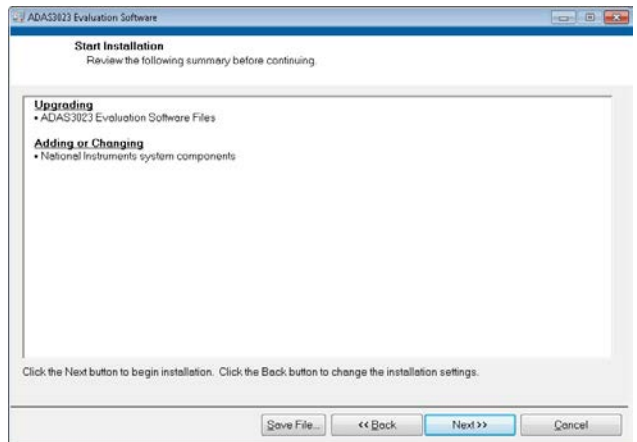

Figure 7. ADAS3023 Evaluation Software Start Installation Evaluation



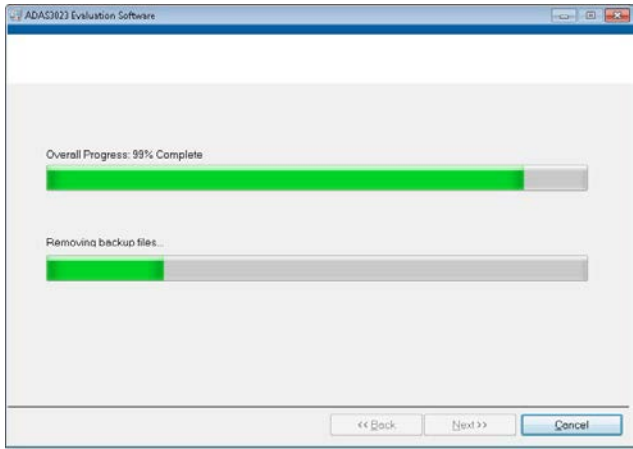

Figure 8. ADAS3023 Evaluation Software, Installation in Progress

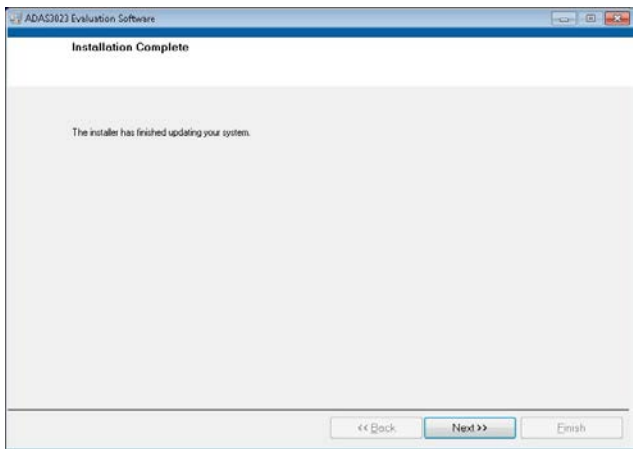

Figure 9. ADAS3023 Evaluation Software Installer, Installation Complete



Figure 10. CED Drivers Install Setup Wizard

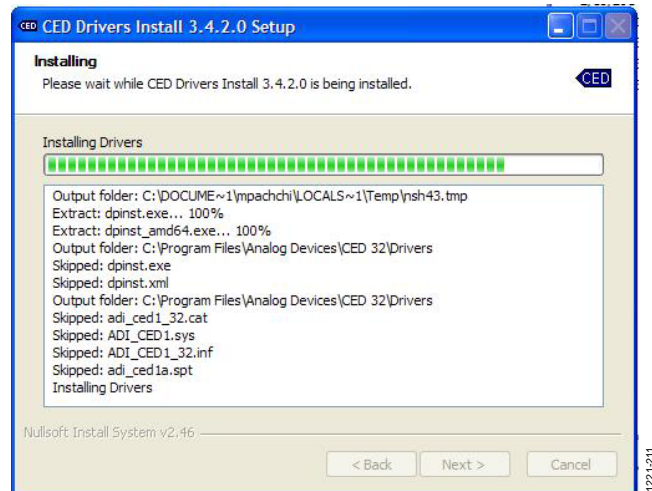

Figure 11. CED Drivers Install Setup Wizard, Installation in Progress

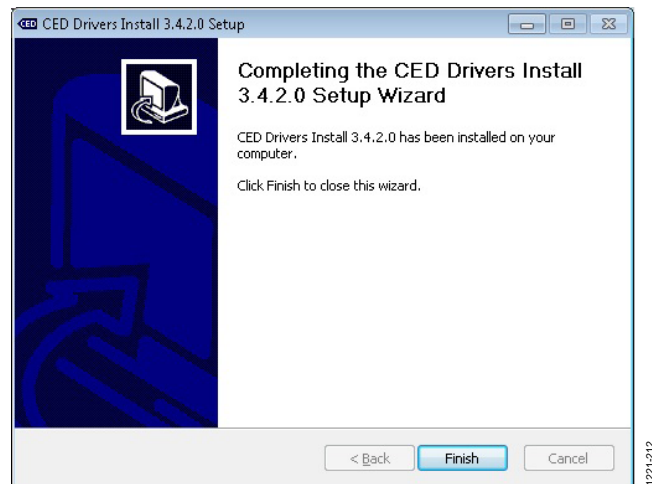

Figure 12. CED Drivers Install Setup Wizard, Installation Complete

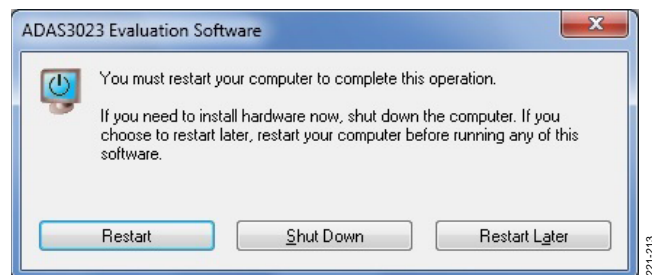
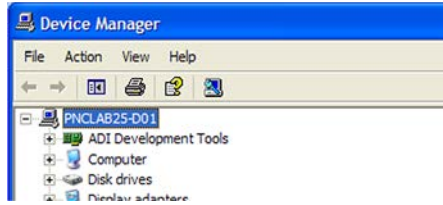

Figure 13. Computer Restart Notice

On some PCs, the **Found New Hardware Wizard** may open. If so, follow the same procedure to install it properly.

The Device Manager can be used to verify that the driver was installed successfully.



11064-006

Figure 14. Device Manager

**Troubleshooting the Installation**

If the driver was not installed successfully, the Device Manager displays a question mark for **Other devices** because Windows does not recognize the EVAL-CEDIZ board.

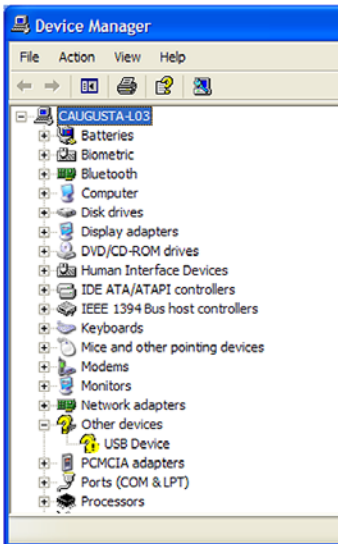

11064-007

Figure 15. Device Manager Troubleshooting

The USB device can be opened to view the uninstalled properties.

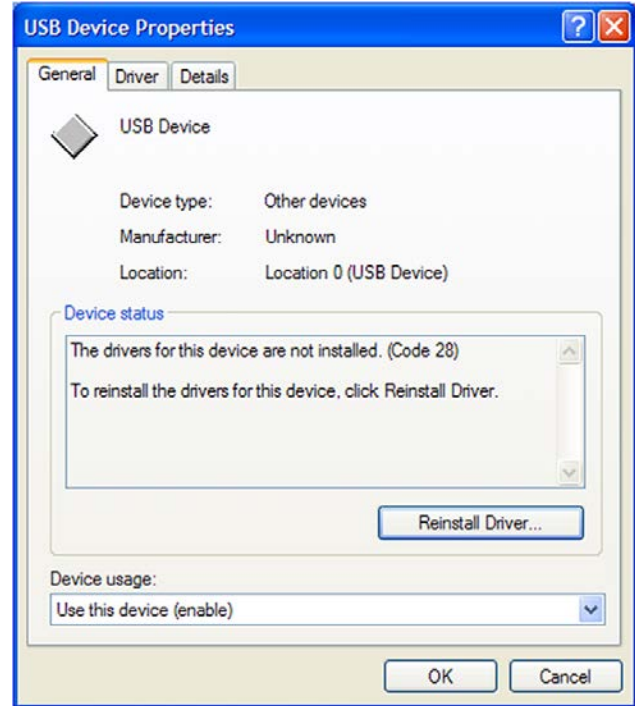

11064-008

Figure 16. USB Device Properties

This is usually the case if the software and drivers were installed by a user without administrator privileges. If so, log on as an administrator with full privileges and reinstall the software.

## POWERING UP THE BOARD

The evaluation board, as configured from the factory, uses the local LDOs for power where necessary. A  $\pm 15$  V dc lab supply must be connected to the board. Test points (yellow and white) are provided for these external supplies.



Figure 17. Test Points

## RUNNING THE SOFTWARE WITH THE HARDWARE CONNECTED

The evaluation board includes software for analyzing the [ADAS3023](#). The [EVAL-CED1Z](#) is required when using the software. The software is used to perform the following tests:

- Histogram tests for determining code transition noise (dc)
- Time domain analysis
- Fast Fourier transforms (FFT) for signal-to-noise ratio (SNR), SNR and distortion (SINAD), total harmonic distortion (THD), and spurious free dynamic range (SFDR)

This evaluation software is located at <local\_drive>:\Program Files\Analog Devices\ADAS3023 Evaluation Software.

To launch the software, click **Start>All Programs>Analog Devices\ADAS3023 Evaluation Software**. You can then apply the signal source and capture the data.

To uninstall the program, click **Start>Control Panel>Add or Remove Programs>Analog Devices ADAS3023 Evaluation Software**.

See Figure 19 to Figure 27 for further details and features of the software.

## SOFTWARE OPERATION

This section describes the full software operation and all windows that appear. When the software is launched, the panel opens and the software searches for hardware connected to the PC. The user software panel launches, as shown in Figure 18. The labels listed in this section correspond to the numbered labels in Figure 18.

### **File Menu (Label 1)**

The **File** menu, labeled 1 in Figure 18, provides the following:

- **Save Captured Data** saves data to a .csv file.
- **Take Screenshot** saves the current screen.
- **Print** prints the window to the default printer.
- **Exit** quits the application.

### **Edit Menu (Label 2)**

The **Edit** menu, labeled 2 in Figure 18, provides the following:

- **Initialize to Default Values:** This option resets the software to its initial state.

### **Help Menu (Label 3)**

The **Help** menu, labeled 3 in Figure 18, offers help from the following sources:

- **Analog Devices website**
- **User Guide**
- **Context Help**
- **About**

### **Throughput (Label 4)**

The default throughput (sampling frequency) is 104 kSPS. The [ADAS3023](#) is capable of operating a maximum sample frequency up to 1000 kSPS.

### **Samples (Label 5)**

Select the number of **Samples** to analyze when running the software. This number is limited to 65,536 samples.

### **Single Capture (Label 6) and Continuous Capture (Label 7)**

**Single Capture** performs a single capture, whereas **Continuous Capture** performs a continuous capture from the ADC.

### **Tabs**

There are four tabs available for displaying the data in different formats.

- Time Domain
- Histogram
- Spectrum
- Summary

To exit the software, click **File>Exit**.

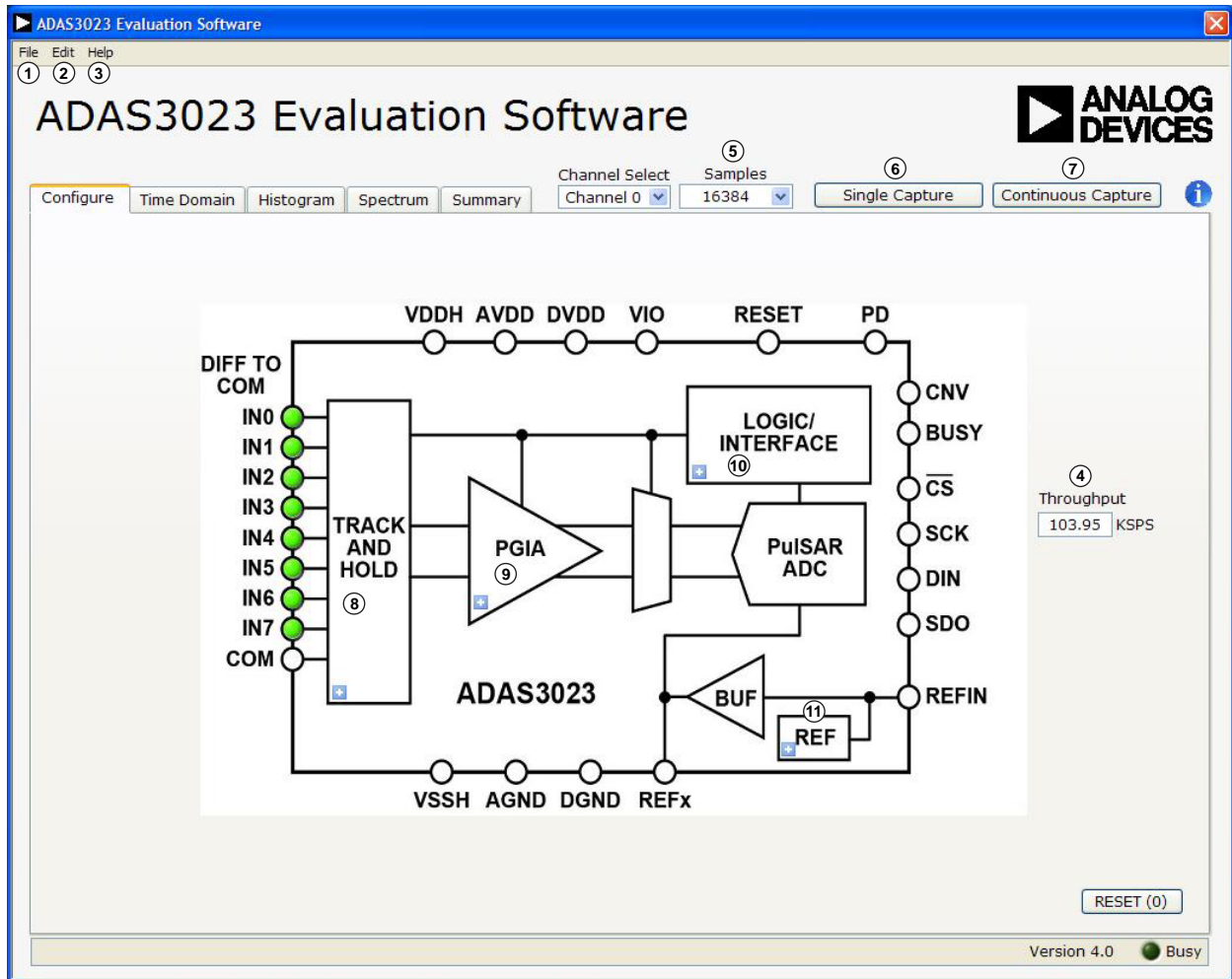

Figure 18. Setup Screen

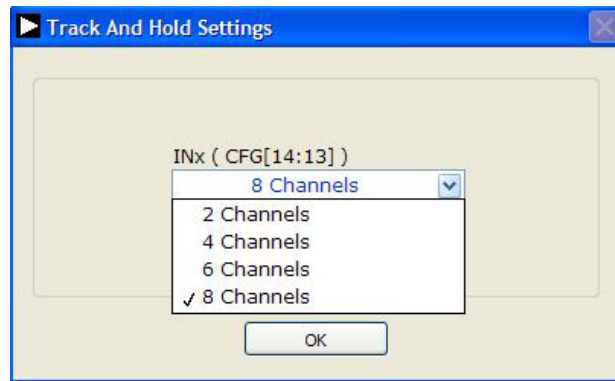

Figure 19. Dialog Box for Label 8, Number of Input Channels Settings

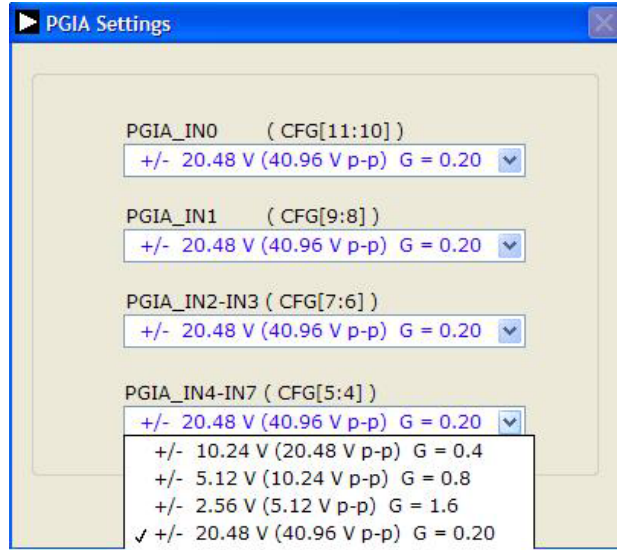

Figure 20. Dialog Box for Label 9, PGIA Settings

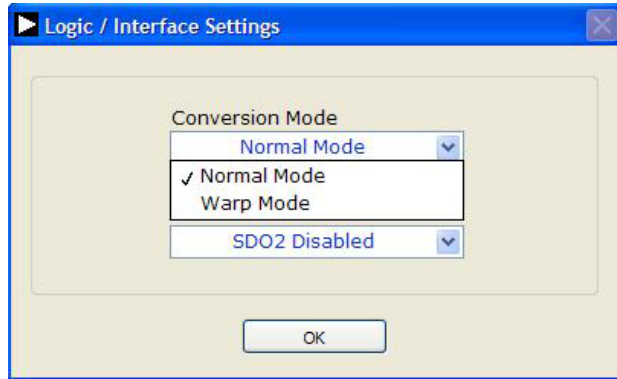

Figure 21. Dialog Box for Label 10, Conversion Mode Settings

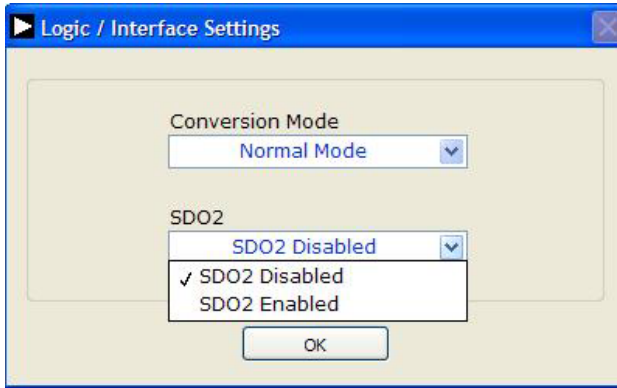

Figure 22. Dialog Box for Label 10, SDO2/BUSY Settings

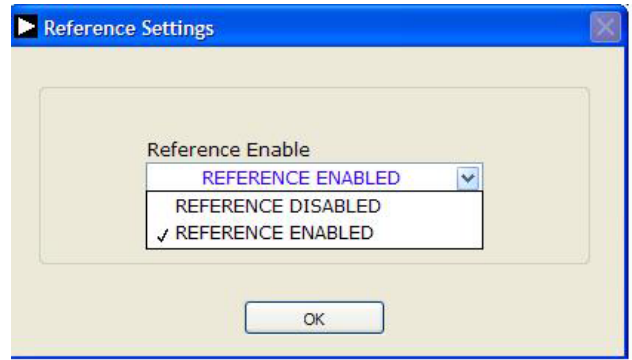

Figure 23. Dialog Box for Label 11, Reference Settings

### Start Up

Refer to the numbered labels in Figure 18. Click the blue buttons to reveal the dialog boxes shown in Figure 19 through Figure 23.

To begin evaluating the device, the on-board supplies must be enabled.

- **RESET** resets the [ADAS3023](#) device to a known state. Click **RESET** twice: once to reset the [ADAS3023](#) and again to bring it out of the reset state. Note that the CFG is also reset to the default condition.
- **Reference Selection:** At this time, it is recommended to use the evaluation board's externally generated reference (default). To select the on-chip reference, remove the P5 and P7 jumpers and click the button in the **REF** block to display the **Reference Settings** dialog box, then choose **REFERENCE ENABLED**.
- **PD (0)** places the [ADAS3023](#) device in power-down. This does not need to take place when starting the software.
- **Serial Data Output 2 (SDO2) Option:** The [ADAS3023](#) busy signal is always output on the **BUSY/SDO2** pin when **CS** is logic high. If **SDO2** is enabled when **CS** is brought low after the **EOC**, the **SDO** outputs the data from Channel 0, Channel 1, Channel 2, and Channel 3 and **SDO2** outputs the data from Channel 4, Channel 5, Channel 6, and Channel 7 after 16 **SCK** rising edges. The conversion result output on this pin synchronizes to the **SCK** falling edges. Click **SDO2 DISABLED** once to display **SDO2 ENABLED**.
- **Click OK:** If the default configuration (number of channels, **PGIA**, reference, and **SDO2** settings) is acceptable, clicking **OK** writes to the [ADAS3023](#) configuration register (**CFG**). The [ADAS3023](#) device is configurable using a 16-bit on-chip register, **CFG** (refer to the [ADAS3023](#) data sheet for more details). Note that after changing any of the **CFG** register settings, **OK** button must be clicked for the new setting to take effect.

### Input Channel

To select the number of input channels to be simultaneously sampled, make a selection from the pull-down menu. (see Figure 19).

### Programmable Gain

The most useful and innovative feature of the [ADAS3023](#) is the on-chip programmable gain instrumentation amplifier. This amplifier has the added flexibility of allowing for inputs ranging from  $\pm 2.56$  V to  $\pm 20.48$  V. Select the appropriate setting for the input voltage span, not including any common-mode signals, since they are rejected. Note that the [ADAS3023](#) devices do not need the usual level shifting that is common in SAR ADC systems. The [ADAS3023](#) devices can accommodate single-ended unipolar and bipolar input signal types.

### Software Controls

Within any of the chart panels, these controls are used to control the display.



Controls the cursor.



Controls zooming in and out.



Controls panning.

**TIME DOMAIN TAB**

Figure 24 illustrates the Time Domain tab. The ADAS3023 output is twos complement output; however, the software outputs the results in straight binary.

Note that Label 1 shows the **Waveform Analysis** that reports the amplitude recorded from the captured signal in addition to the frequency of the signal tone, and Label 2 shows that Y-axis units can be displayed in volts or code (LSB).

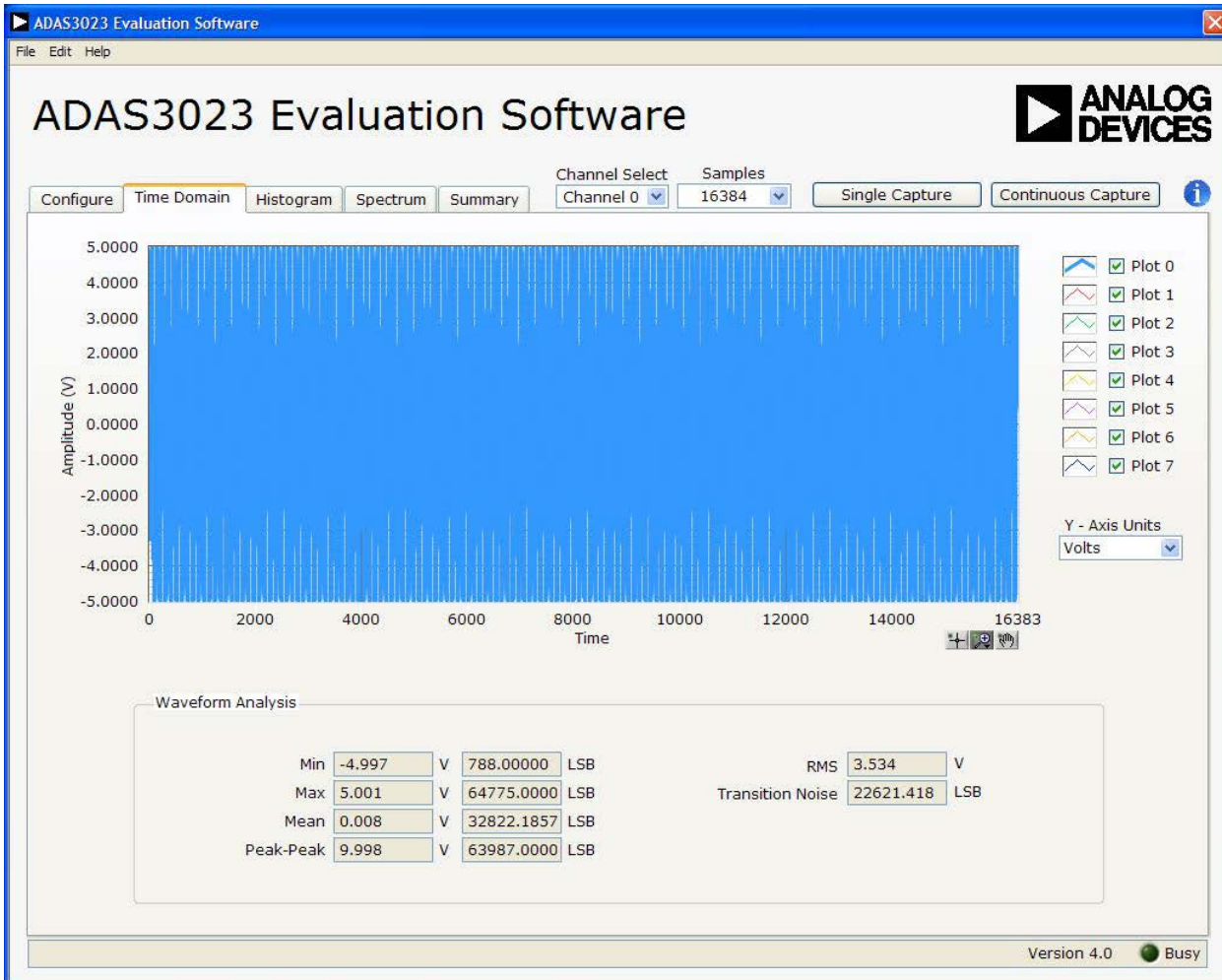

Figure 24. Time Domain Tab



**HISTOGRAM TAB**

The histogram is most often used for dc testing or ac testing, where a user tests the ADC for the code distribution for dc input and computes the mean and standard deviation, or transition noise, of the converter, and displays the results. Raw data is captured and passed to the PC for statistical computations. Figure 25 shows the Histogram tab.

To perform a histogram test,

1. Select the **Histogram** tab.
2. Click **Single Capture** or **Continuous Capture**.

**DC Testing**

To test other dc values, apply a source to the selected analog inputs IN[7:0]\_I via test points or P1. It may be required to

filter the signal to make the dc source noise compatible with that of the ADC. Note that 0805 and 0603 SMT pads are provided in each signal path and can be used for filtering the source, if necessary.

**AC Testing**

Figure 25 shows the histogram for a 1 kHz sine wave applied to the analog inputs IN[7:0]\_I via test points or P1 from a quality precision signal source, such as Audio Precision. It may be required to filter the input signal from the ac source. There is no suggested band-pass filter, but consider all choices carefully. The **Waveform Analysis** (Label 1) chart displays the various measured histogram values for the **ADAS3023**.

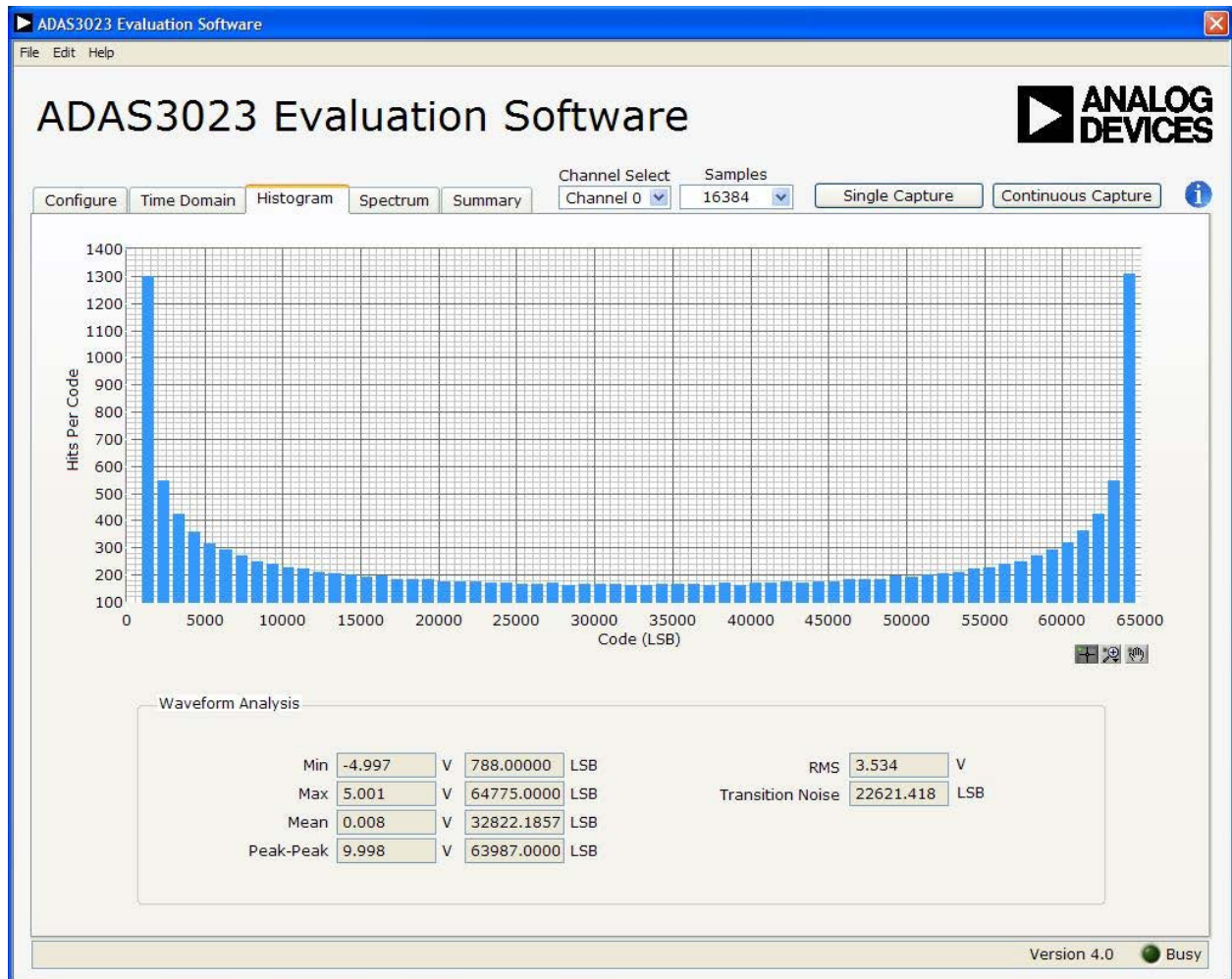

Figure 25. Histogram Tab

**SPECTRUM TAB**

Figure 26 shows the FFT spectrum capture tab. This tab tests the traditional ac characteristics of the converter and displays a fast Fourier transform (FFT) of the results. As in the histogram test, raw data is captured and passed to the PC where the FFT is performed, displaying SNR, SINAD, THD, and SFDR.

To perform an ac test, apply a sinusoidal signal to the evaluation board to any pair of the analog inputs IN[7:0]\_I, either via test points or P1. Very low distortion—a better than 130 dB input signal source, such as Audio Precision—is required to allow

true evaluation of the part. One possibility is to filter the input signal from the ac source. There is no suggested band-pass filter, but carefully consider the choices. Figure 26 displays the results of the captured data.

- The top part of the image displays the FFT results including SNR, dynamic range, THD, SINAD, and noise performance (see Label 1).
- The lower part of the image displays the fundamental frequency and amplitude in addition to the 2<sup>nd</sup> to 5<sup>th</sup> harmonics (see Label 2).

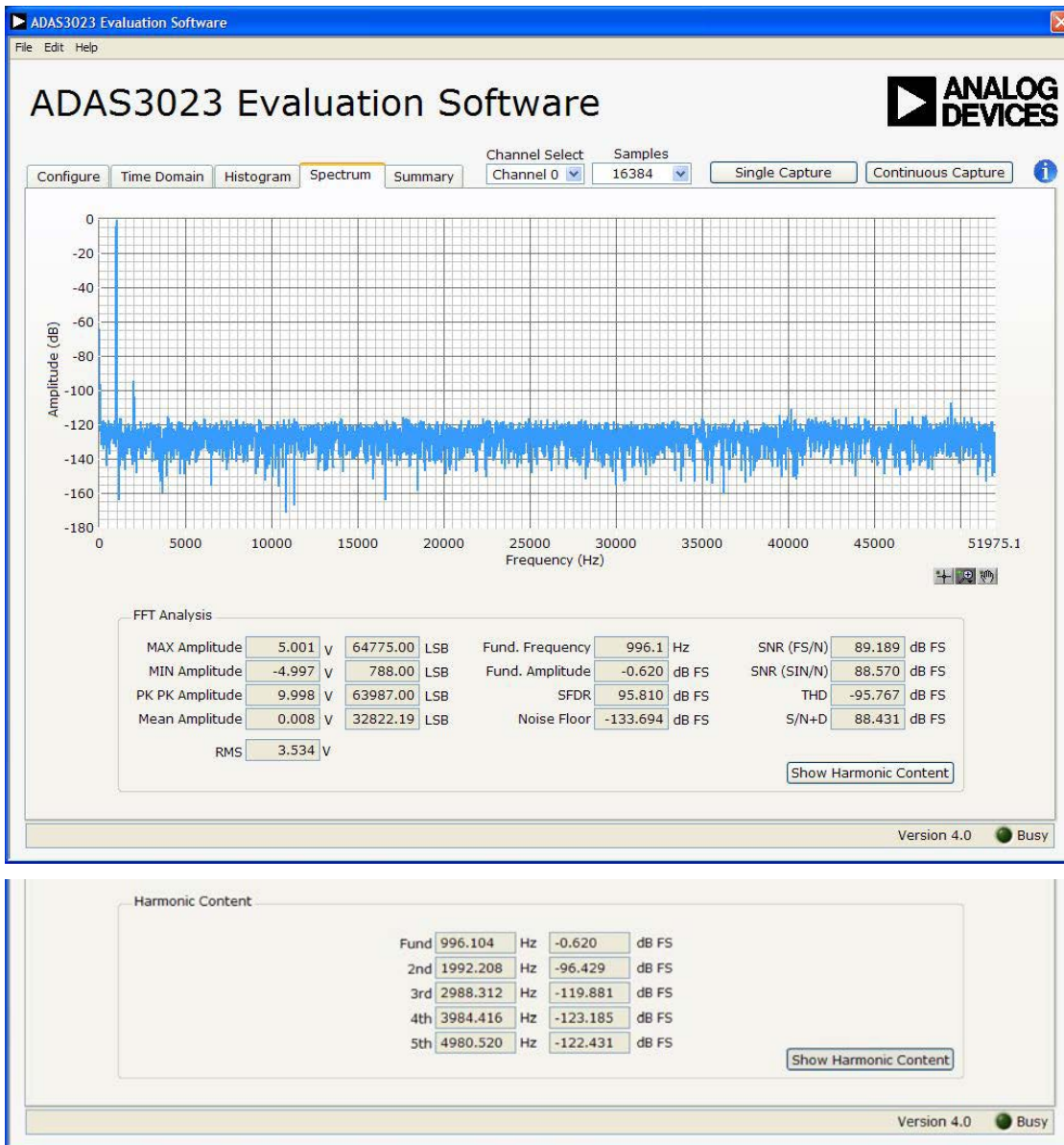

Figure 26. FFT Spectrum with FFT Results (Top) and with Harmonic Content Results (Bottom)

11221-226

**SUMMARY TAB**

Figure 27 shows the Summary tab, which summarizes all the data capture information and displays it in one panel with a

synopsis of the information, including key performance parameters such as SNR, THD, and SINAD.

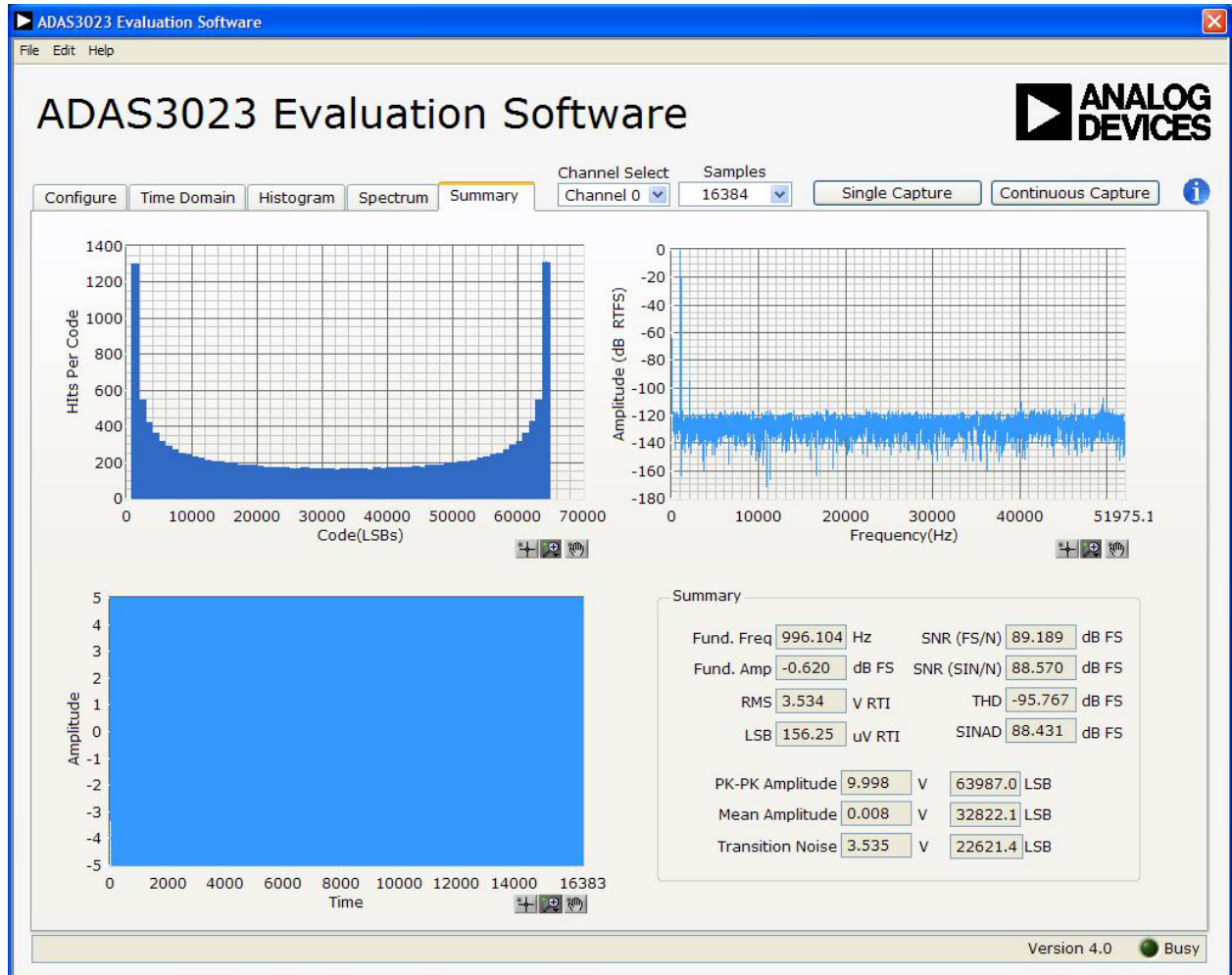

Figure 27. Summary Tab

EVALUATION BOARD SCHEMATICS AND ARTWORK

11221-020

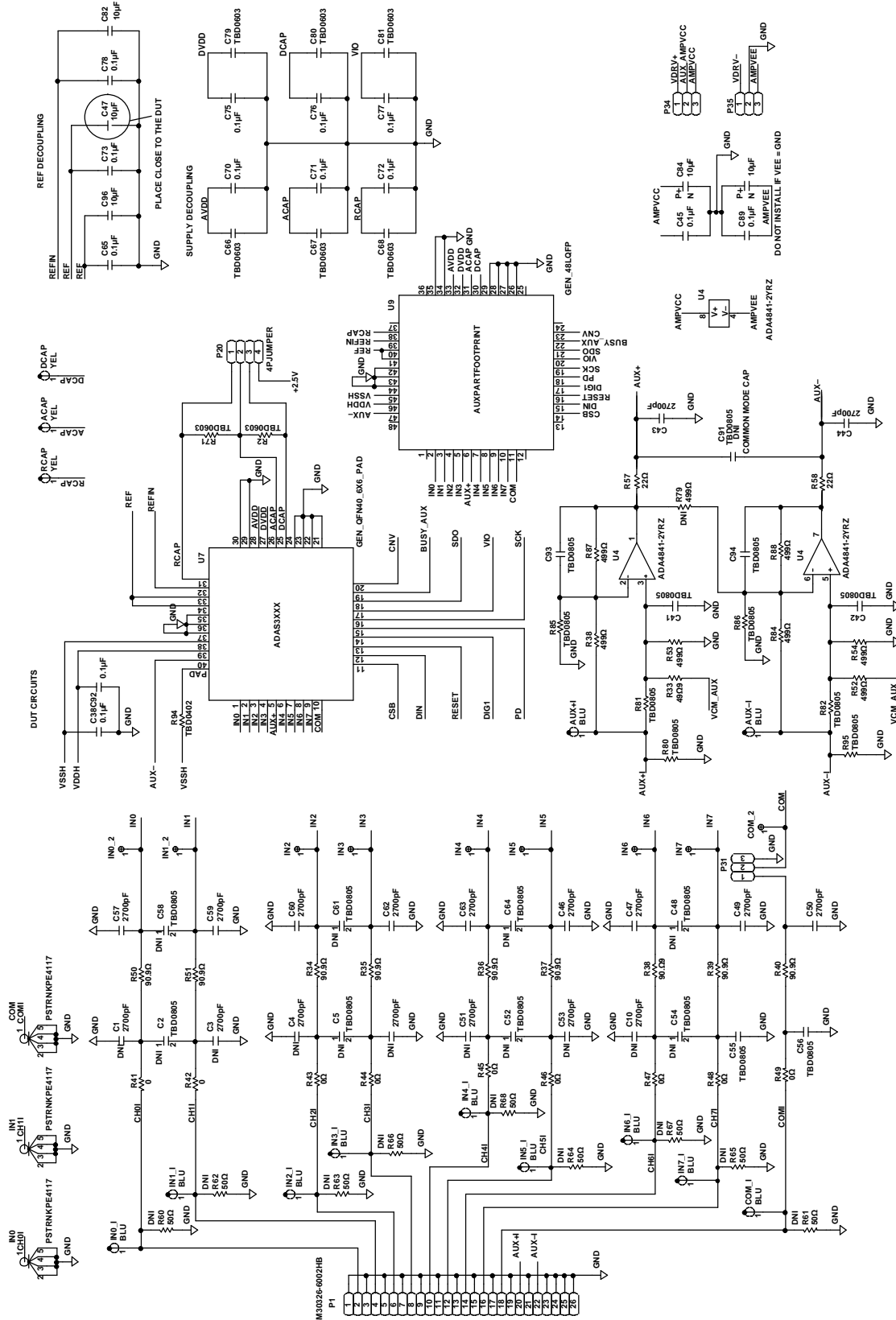

Figure 28. Schematic, DUT, Analog

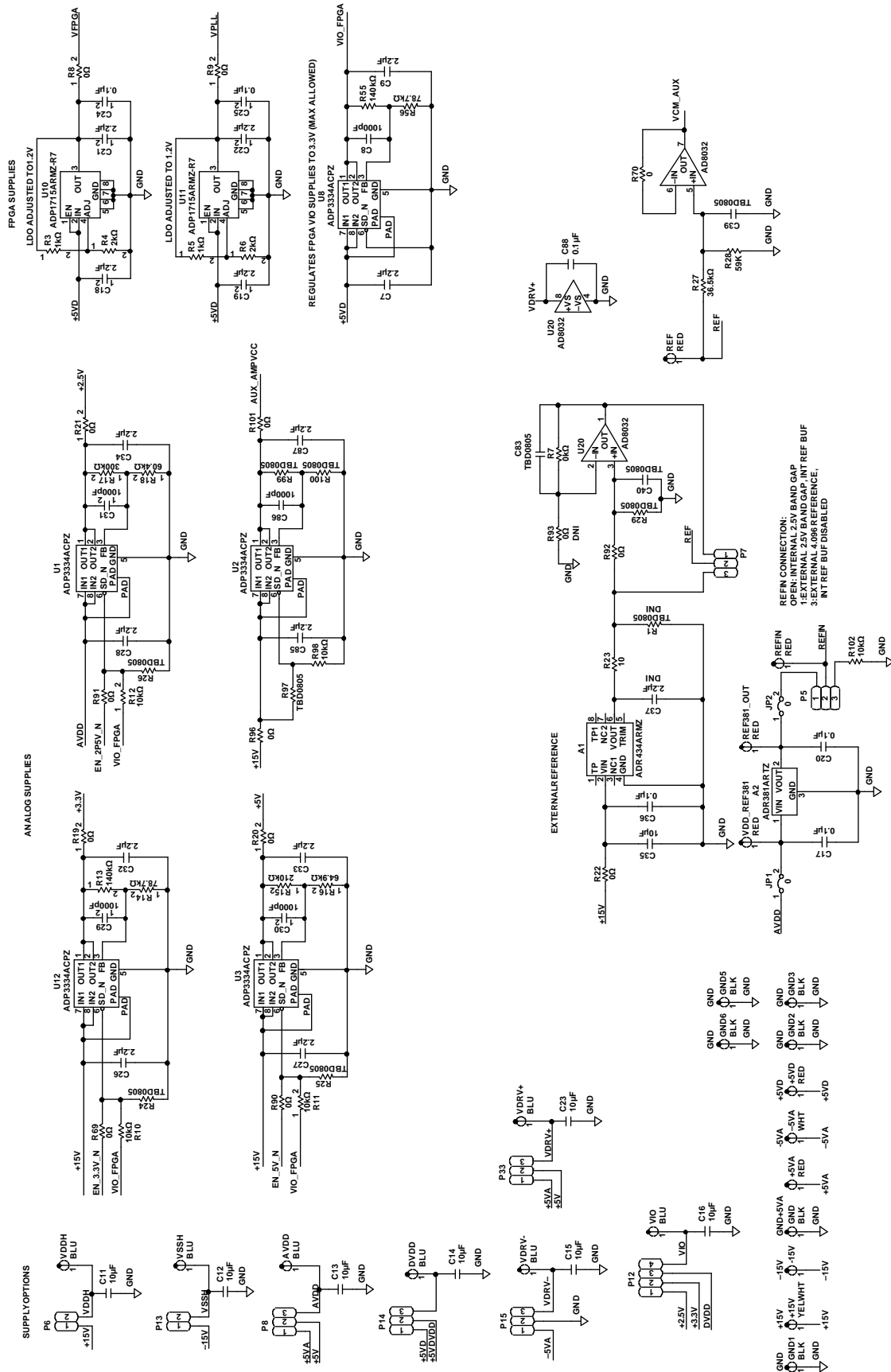

Figure 29. Schematic Power  
Rev. B | Page 21 of 30

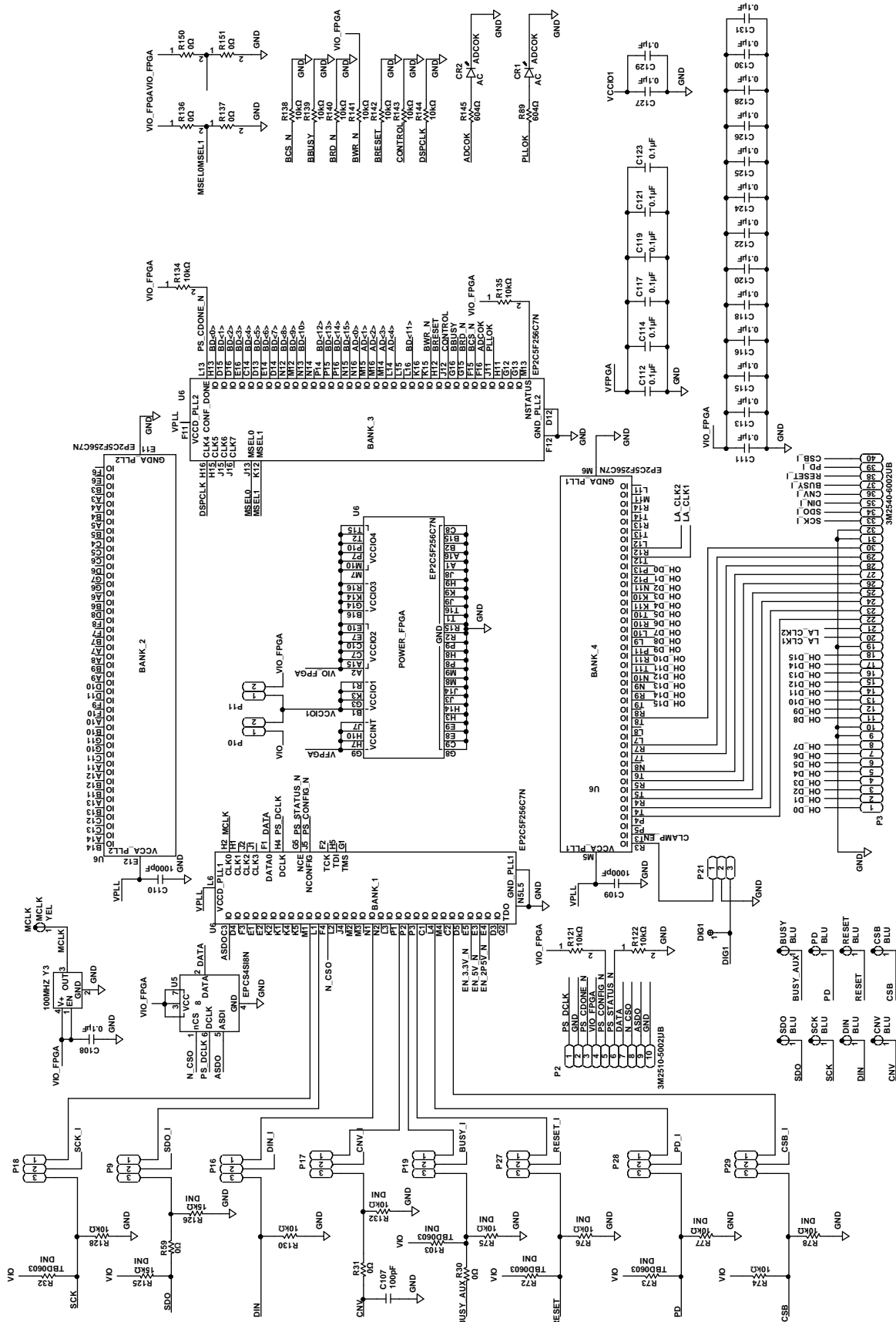

Figure 30. Schematic, FPGA  
Rev. B | Page 22 of 30

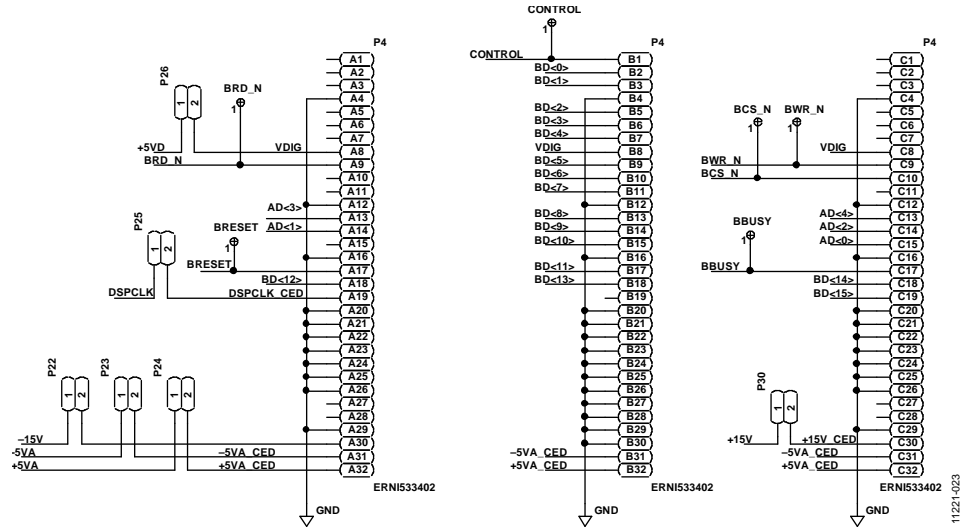

Figure 31. Schematic, 96-Pin Interface

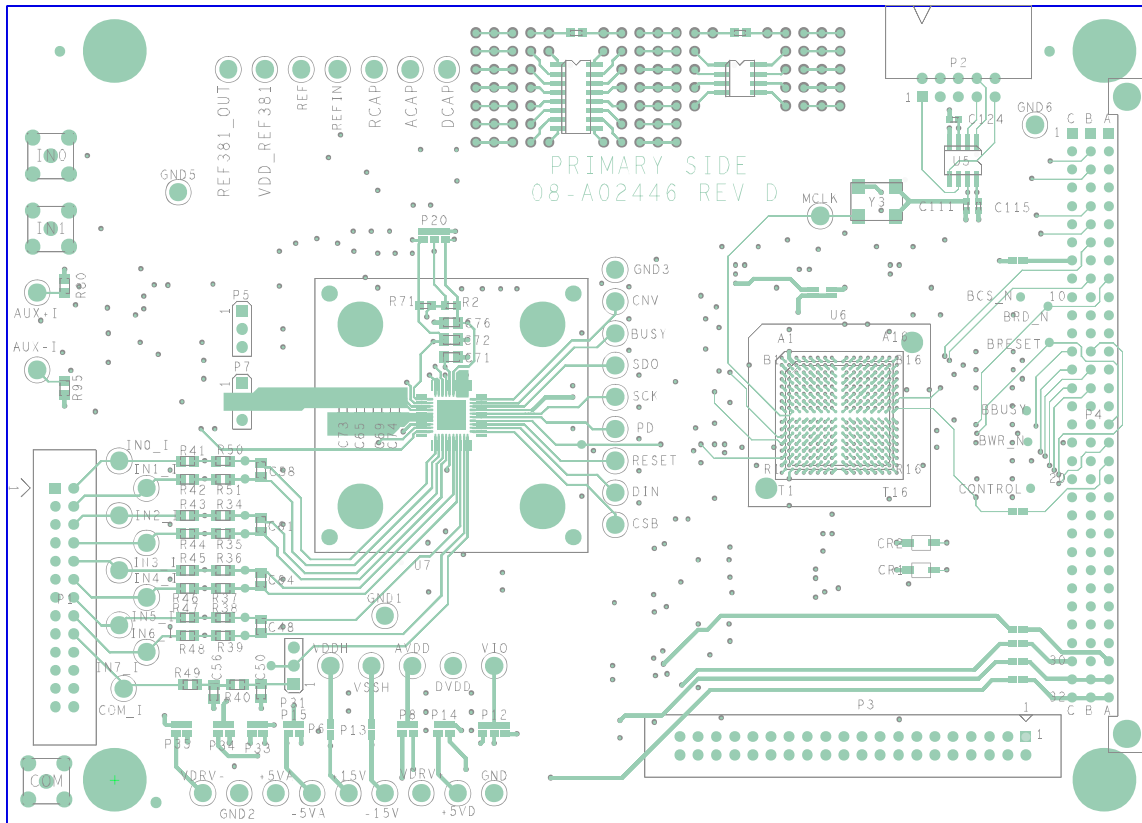
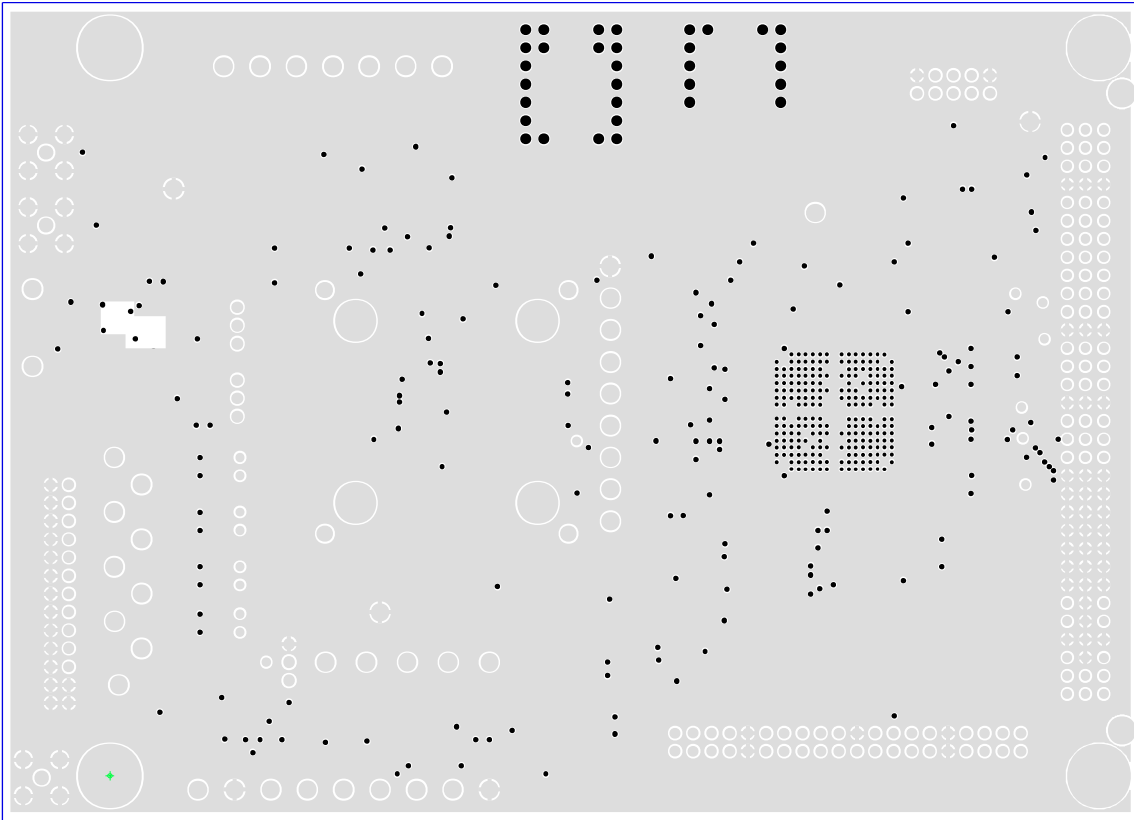
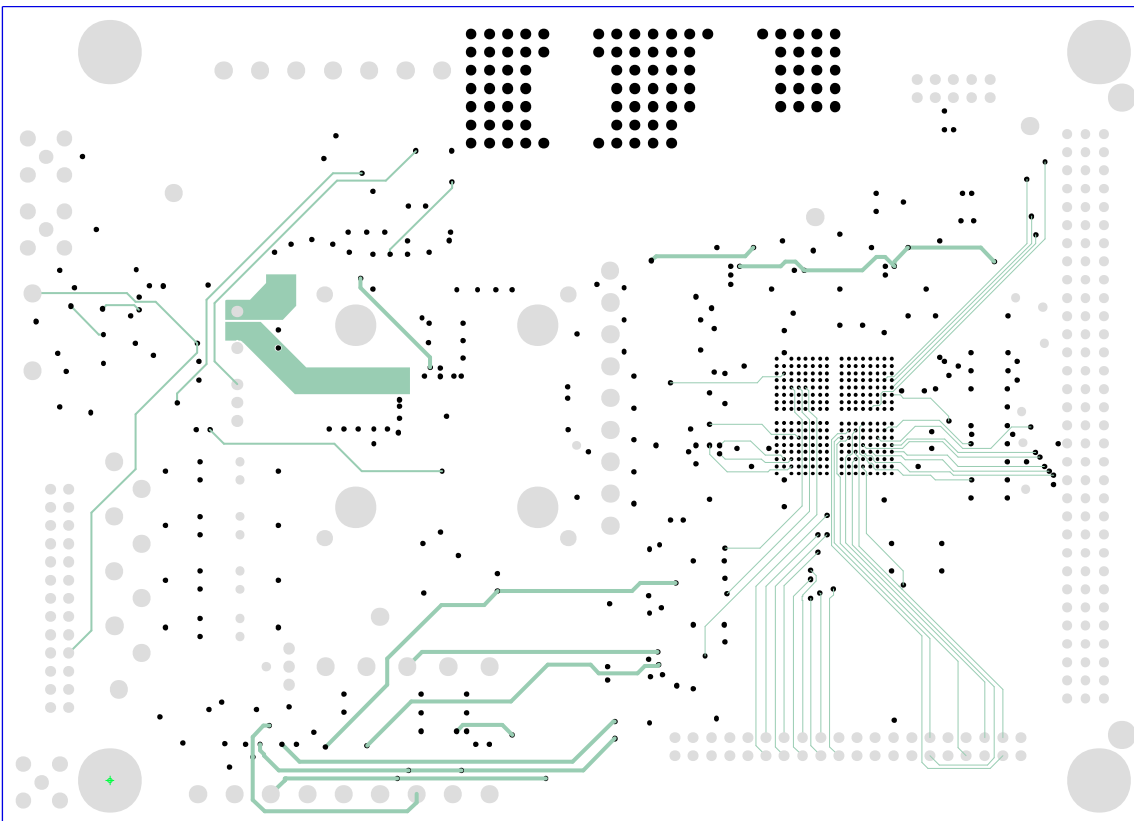

Figure 32. Silkscreen, Top



11221-025

Figure 33. Silkscreen, Bottom



11221-026

Figure 34. Top Layer 1



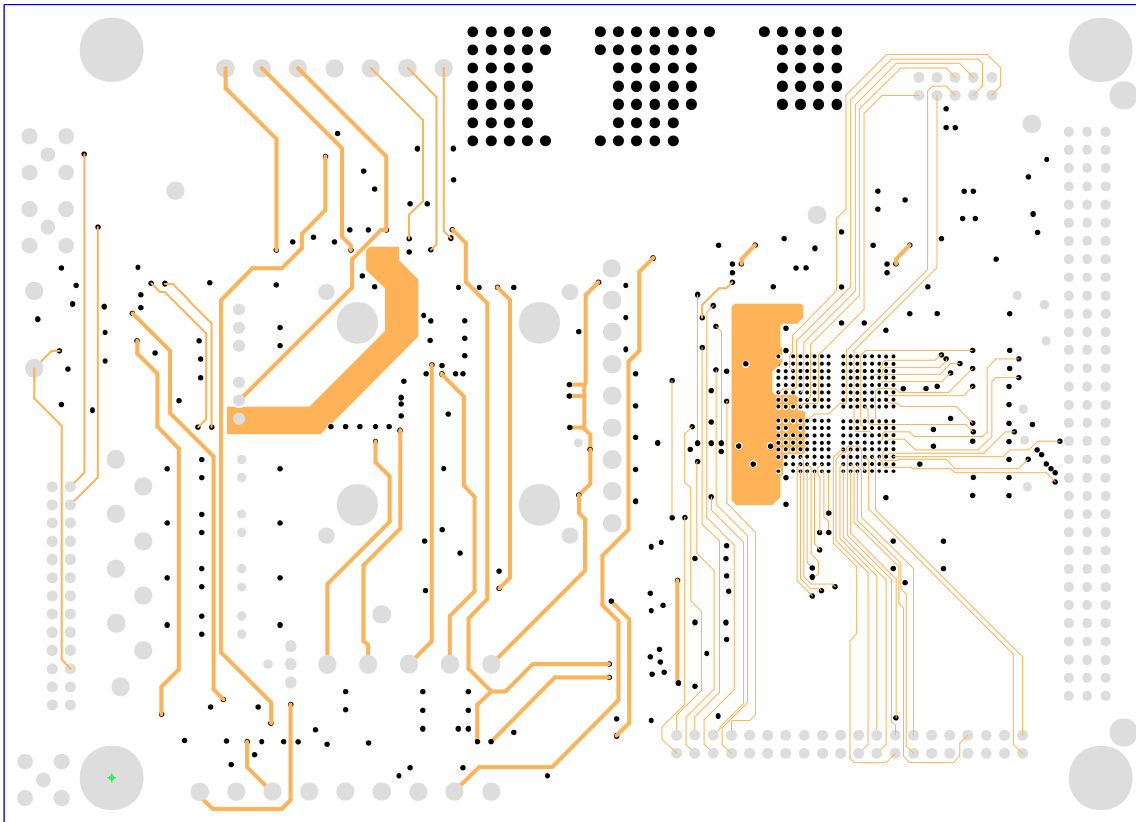

11221-027

Figure 35. GND Layer 2

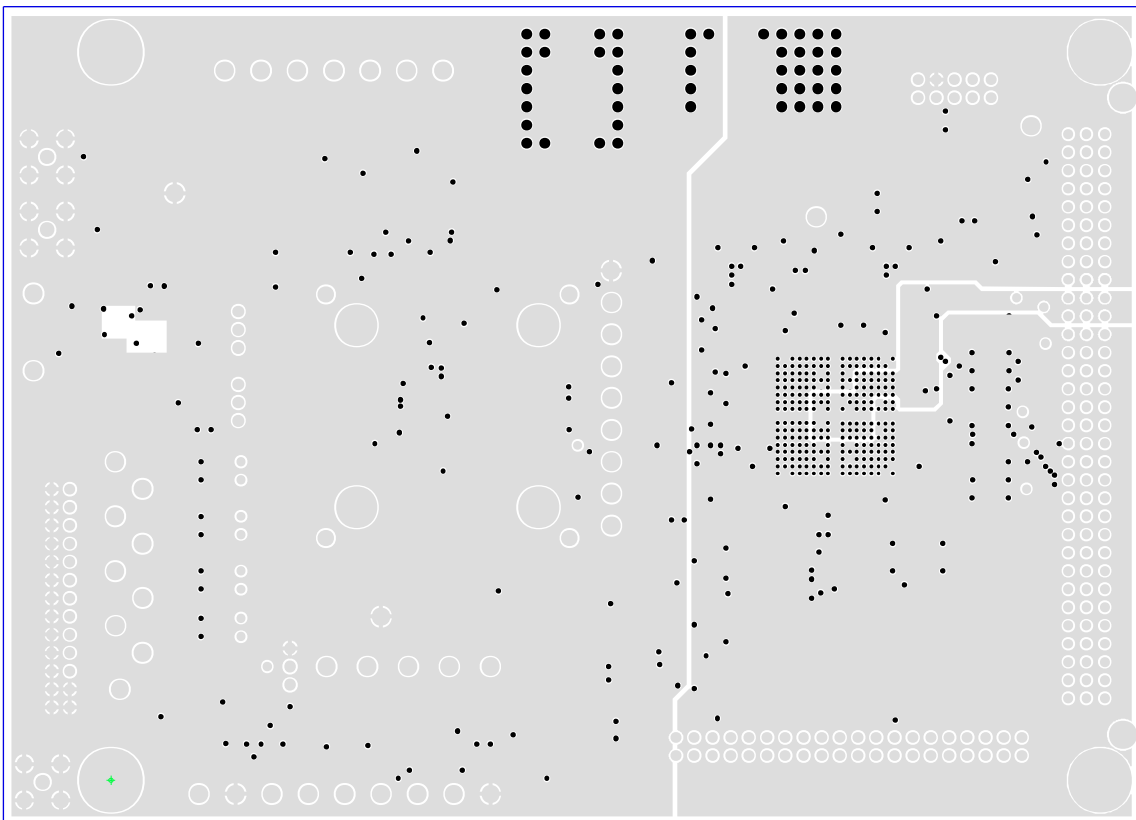

11221-028

Figure 36. Signal Layer 3

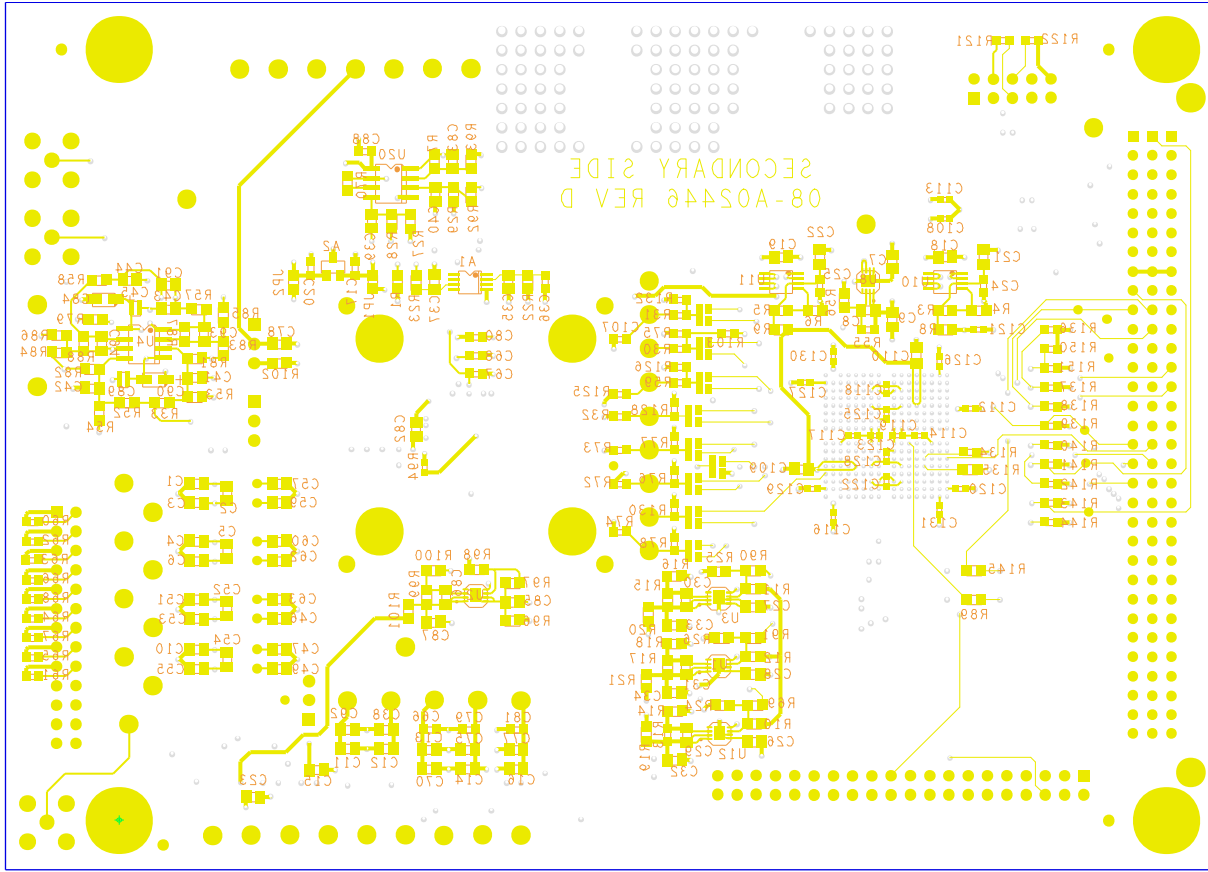

Figure 37. Signal Layer 4

11221-029

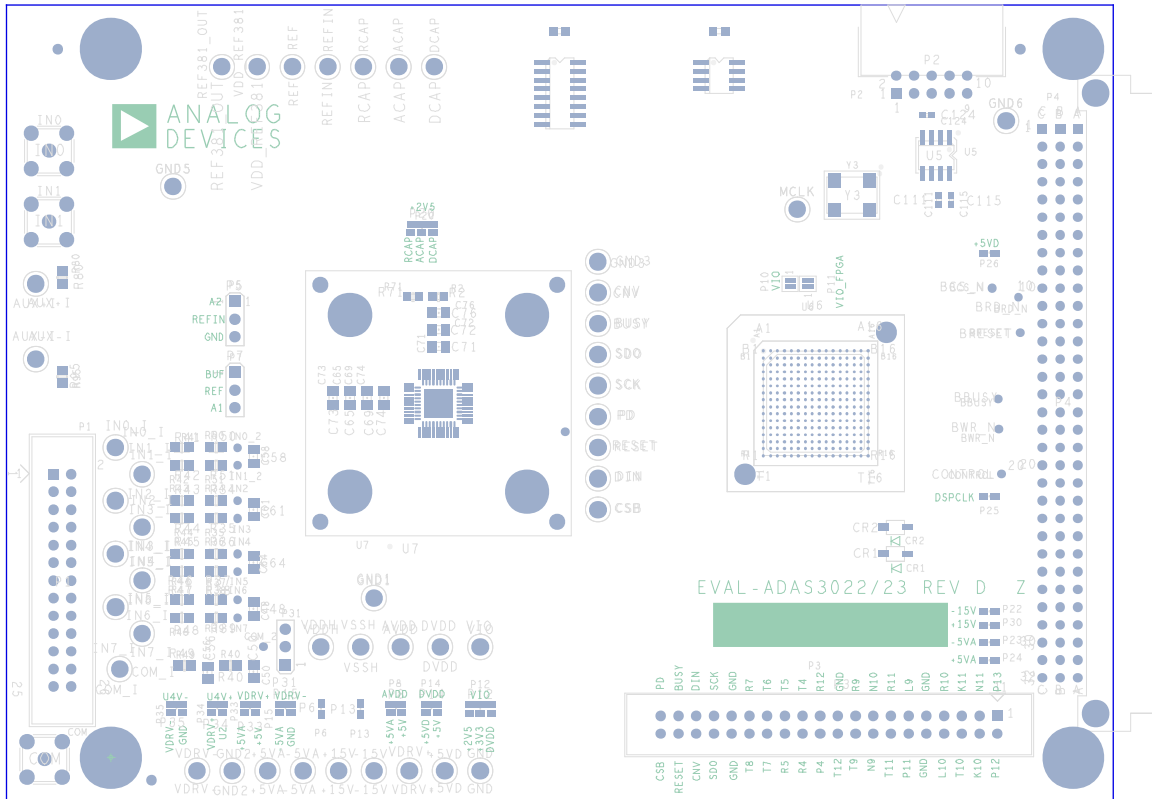

Figure 38. Power Layer 5

11221-030

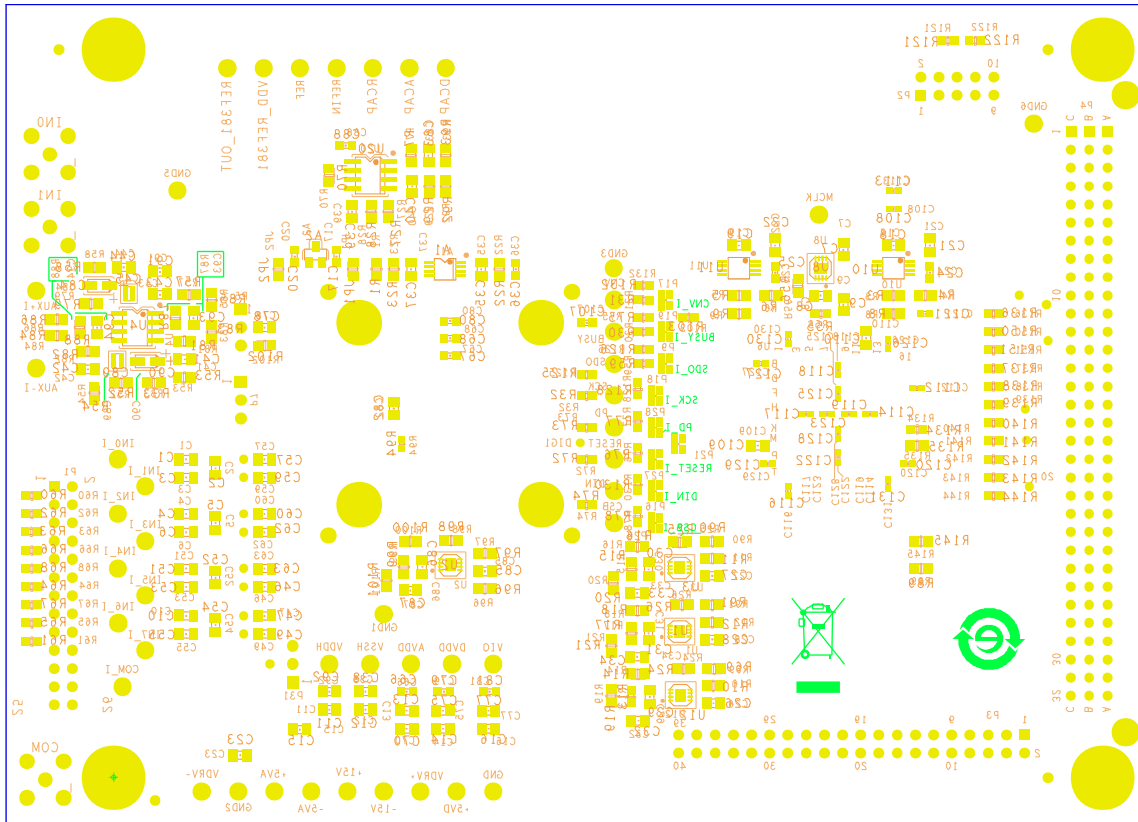

Figure 39. Bottom Layer 6

11221-031

## PRODUCTS ON THIS EVALUATION BOARD

### BILL OF MATERIALS

Table 8.

Qty	Reference Description	Part Description	Value	Manufacturer	Part Number	Instructions
5	U1 to U3, U8, U12	IC-ADI LDO	–	Analog Devices	<a href="#">ADP3334ACPZ</a>	
2	U10, U11	IC-ADI LDO	–	Analog Devices	<a href="#">ADP1715ARMZ</a>	
1	U20	IC-ADI OPAMP	–	Analog Devices	<a href="#">AD8032ARZ</a>	
1	U4	IC-ADI OPAMP	–	Analog Devices	<a href="#">ADA4841-2YRZ</a>	
1	A1	IC-ADI REFERENCE	–	Analog Devices	<a href="#">ADR434ARMZ</a>	
1	A2	IC-ADI REFERENCE	–	Analog Devices	<a href="#">ADR381ARTZ</a>	
1	U6	IC-CYCLONE II	–	Altera Devices	EP2C5F256C7N	
1	U5	IC SERIAL CONFIG	–	Altera Devices	EPCS4SI8N	
1	Y3	IC CRYSTAL OSC	100 MHZ	C-MAC	SPXO009437-CFPS-73	
22	C108, C111 to C131	CAP X7R 0402	0.1 µF	Murata	GRM155R71C104KA88D	
2	C45, C89	CAP X7R 0508	0.1 µF	TDK	C1220X7R1E104K	
1	C107	CAP NPO 0603	100 pF	Phycomp	2238 867 15101	DNI
6	C17, C20, C24, C25, C36, C88	CAP X8R 0603	0.1 µF	Murata	GRM188R7E104KA01D	
6	C66 to C68, C79 to C81	CAP X7R 0603				DNI
11	C38, C65, C70, C71, C72, C73, C75, C76, C77, C78, C92	CAP X7R 0805	0.1 µF	Murata	GRM21BR71H104KA01L	
7	C8, C29 to C31, C86, C109, C110	CAP COG 0805	1000 pF	Murata	GRM2165C2A102JA01D	
11	C43, C44, C46, C47, C49, C50, C57, C59, C60, C62, C63	CAP NPO 0805	2700 pF	Murata	GRM2165C1H272JA01D	
9	C1, C3, C4, C6, C10, C51, C53, C55, C56	CAP NPO 0805	2700 pF	Murata	GRM2165C1H272JA01D	DNI
8	C2, C5, C48, C52, C54, C58, C61, C64	CAP NPO 0805	5600 pF	Murata	GRM2195C1H562JA01D	DNI
15	C7, C9, C18, C19, C21, C22, C26 to C28, C32 to C34, C37, C85, C87	CAP X5R 0805	2.2 µF	Murata	GRM21BR71E225KA73L	
10	C11 to C16, C23, C35, C69, C74	CAP X5R 0805	10 µF	Murata	GRM21BR61C106KE15L	
2	C84, C90	CAP TANT	10 µF	AVX	TAJA106K010RNJ	
7	C39 to C42, C91, C93, C94	CAP 0805		Murata	–	DNI
1	R94	RES 0402	0	Panasonic-ECG	ERJ-2GE0R00X	
4	R32, R72, R73, R103	RES 0603	–	Panasonic-ECG	–	DNI
6	R2, R71, R125, R126, R136, R151	RES 0603	–	Panasonic-ECG	–	DNI
6	R30, R31, R59, R137, R137, R151	RES 0603	0	Panasonic-ECG	ERJ-3GEY0R00V	
9	R60 to R68	RES 0603, 5%	50	Panasonic-ECG	ERJ-3EKF49R9V	
18	R74 to R78, R121, R122, R128, R130, R132, R134, R138 to R144	RES 0603, 5%	10 K	Panasonic-ECG	ERJ-3EKF1002V	
2	R125, R126	RES 0603, 5%	15 K	Yageo	RC0603FR-0715KL	DNI
2	R13, R55	RES 0603, 1%	140 K	Panasonic-ECG		
14	R1, R24 to R26, R29, R80 to R82, R85, R86, R95, R97, R99, R100	RES 0805	–	Panasonic-ECG	–	DNI
25	R7 to R9, R19 to R23, R41 to R49, R69, R70, R90 to R93, R96, R101	RES 0805	0	Panasonic-ECG	ERJ-6GEY0R00V	
2	R57, R58	RES 0805, 1%	22	Panasonic-ECG	ERJ-6ENF22R0V	
9	R34 to R40, R50, R55	RES 0805, 1%	90.9	Panasonic-ECG	ERJ-6ENF90R9V	
1	R27	RES 0805, 1%	365	Panasonic-ECG	ERJ-6ENF3652V	

Qty	Reference Description	Part Description	Value	Manufacturer	Part Number	Instructions
9	R33, R52 to R54, R79, R83, R84, R87, R88	RES 0805, 1%	499	Panasonic-ECG	ERJ-6ENF4990V	
1	R28	RES 0805, 1%	590	Panasonic-ECG	ERJ-6ENF5902V	
2	R89, R145	RES 0805, 1%	604	Panasonic-ECG	ERJ-6ENF6040V	
2	R3, R5	RES 0805, 5%	1 K	Panasonic-ECG	ERJ-6ENF1001V	
2	R4, R6	RES 0805, 5%	2 K	Panasonic-ECG	ERJ-6ENF2001V	
6	R10 to R12, R98, R102, R135	RES 0805, 5%	10 K	Panasonic-ECG	ERJ-6ENF1002V	
1	R16	RES 0805, 1%	64.9 K	Panasonic-ECG	ERJ-6ENF6492V	
2	R14, R56	RES 0805, 1%	78.7 K	Panasonic-ECG	ERJ-6ENF7872V	
1	R18	RES 0805, 1%	95.3 K	Panasonic-ECG	ERJ-6ENF6042V	
1	R17	RES 0805, 1%	107 K	Yageo	RC0805FR-07300KL	
1	R15	RES 0805, 1%	210 K	Panasonic-ECG	ERJ-6ENF2103V	
2	CR1,CR2	LED	Green	CML	CMD28-21VGCTR8T1	
3	P5, P7, P31	CONN-3 PIN MALE	Breakaway	Samtec	TSW-103-08-G-S	
1	P2	CONN-10 PIN MALE	RA, shroud	3M	2510-5002UB	
1	P1	CONN-26 PIN MALE	Shroud	3M	30326-6002HB	
1	P3	CONN-40 PIN MALE	RA, shroud	3M	2540-6002UB	
1	P4	CONN-96 PIN MALE	RA, DIN	ERNI	533402	
6	GND(S)	Test point, black	-	Components Corp.	TP-104-01-00	
2	+15 V, MCLK	Test point, yellow	-	Components Corp.	TP-104-01-04	
4	REF, +5 V A, +5 V D, REFIN	Test point, red	-	Components Corp.	TP-104-01-02	
2	-15 V, -5 VA	Test point, white	-	Components Corp.	TP-104-01-09	
26	PD, CNV, CSB, DIN, SCK, SDO, VIO, AVDD, BUSY, DVDD, VDDH, VSSH, AUX+I, AUX-I, COM_I, IN0_I-IN7_I, RESET, VDRV+, VDRV-	Test point, blue	-	Components Corp.	TP-104-01-06	

## RELATED LINKS

Resource	Description
<a href="#">ADAS3023</a>	Product Page, <a href="#">ADAS3023</a> , 16-Bit, 8-Channel Simultaneous Sampling Data Acquisition System
<a href="#">AD8032</a>	Product Page, <a href="#">AD8031/AD8032</a> , Low Power, Low Noise Amplifier
<a href="#">ADR434</a>	Product Page, <a href="#">ADR434</a> , 4.096 Precision Reference
<a href="#">ADP1715</a>	Product Page, <a href="#">ADP1715</a> , 500 mA Low Dropout CMOS Linear Regulator with Soft Start
<a href="#">ADP3334</a>	Product Page, <a href="#">ADP3334</a> , High Accuracy Low I <sub>Q</sub> , 500 mA, ANYCAP®, Adjustable Low Dropout Regulator
<a href="#">EVAL-CED1Z</a>	Product Page, Converter and Evaluation Development board
<a href="#">AN-931</a>	Application Note, Understanding PuLSAR ADC Support Circuitry
<a href="#">CN0201</a>	Circuit from the Lab, Complete 5 V, Single-Supply, 8-Channel Multiplexed Data Acquisition System with PGIA for Industrial Signal Levels

**ESD Caution**

**ESD (electrostatic discharge) sensitive device.** Charged devices and circuit boards can discharge without detection. Although this product features patented or proprietary protection circuitry, damage may occur on devices subjected to high energy ESD. Therefore, proper ESD precautions should be taken to avoid performance degradation or loss of functionality.

**Legal Terms and Conditions**

By using the evaluation board discussed herein (together with any tools, components documentation or support materials, the "Evaluation Board"), you are agreeing to be bound by the terms and conditions set forth below ("Agreement") unless you have purchased the Evaluation Board, in which case the Analog Devices Standard Terms and Conditions of Sale shall govern. Do not use the Evaluation Board until you have read and agreed to the Agreement. Your use of the Evaluation Board shall signify your acceptance of the Agreement. This Agreement is made by and between you ("Customer") and Analog Devices, Inc. ("ADI"), with its principal place of business at One Technology Way, Norwood, MA 02062, USA. Subject to the terms and conditions of the Agreement, ADI hereby grants to Customer a free, limited, personal, temporary, non-exclusive, non-sublicensable, non-transferable license to use the Evaluation Board FOR EVALUATION PURPOSES ONLY. Customer understands and agrees that the Evaluation Board is provided for the sole and exclusive purpose referenced above, and agrees not to use the Evaluation Board for any other purpose. Furthermore, the license granted is expressly made subject to the following additional limitations: Customer shall not (i) rent, lease, display, sell, transfer, assign, sublicense, or distribute the Evaluation Board; and (ii) permit any Third Party to access the Evaluation Board. As used herein, the term "Third Party" includes any entity other than ADI, Customer, their employees, affiliates and in-house consultants. The Evaluation Board is NOT sold to Customer; all rights not expressly granted herein, including ownership of the Evaluation Board, are reserved by ADI. CONFIDENTIALITY. This Agreement and the Evaluation Board shall all be considered the confidential and proprietary information of ADI. Customer may not disclose or transfer any portion of the Evaluation Board to any other party for any reason. Upon discontinuation of use of the Evaluation Board or termination of this Agreement, Customer agrees to promptly return the Evaluation Board to ADI. ADDITIONAL RESTRICTIONS. Customer may not disassemble, decompile or reverse engineer chips on the Evaluation Board. Customer shall inform ADI of any occurred damages or any modifications or alterations it makes to the Evaluation Board, including but not limited to soldering or any other activity that affects the material content of the Evaluation Board. Modifications to the Evaluation Board must comply with applicable law, including but not limited to the RoHS Directive. TERMINATION. ADI may terminate this Agreement at any time upon giving written notice to Customer. Customer agrees to return to ADI the Evaluation Board at that time. LIMITATION OF LIABILITY. THE EVALUATION BOARD PROVIDED HEREUNDER IS PROVIDED "AS IS" AND ADI MAKES NO WARRANTIES OR REPRESENTATIONS OF ANY KIND WITH RESPECT TO IT. ADI SPECIFICALLY DISCLAIMS ANY REPRESENTATIONS, ENDORSEMENTS, GUARANTEES, OR WARRANTIES, EXPRESS OR IMPLIED, RELATED TO THE EVALUATION BOARD INCLUDING, BUT NOT LIMITED TO, THE IMPLIED WARRANTY OF MERCHANTABILITY, TITLE, FITNESS FOR A PARTICULAR PURPOSE OR NON-INFRINGEMENT OF INTELLECTUAL PROPERTY RIGHTS. IN NO EVENT WILL ADI AND ITS LICENSORS BE LIABLE FOR ANY INCIDENTAL, SPECIAL, INDIRECT, OR CONSEQUENTIAL DAMAGES RESULTING FROM CUSTOMER'S POSSESSION OR USE OF THE EVALUATION BOARD, INCLUDING BUT NOT LIMITED TO LOST PROFITS, DELAY COSTS, LABOR COSTS OR LOSS OF GOODWILL. ADI'S TOTAL LIABILITY FROM ANY AND ALL CAUSES SHALL BE LIMITED TO THE AMOUNT OF ONE HUNDRED US DOLLARS (\$100.00). EXPORT. Customer agrees that it will not directly or indirectly export the Evaluation Board to another country, and that it will comply with all applicable United States federal laws and regulations relating to exports. GOVERNING LAW. This Agreement shall be governed by and construed in accordance with the substantive laws of the Commonwealth of Massachusetts (excluding conflict of law rules). Any legal action regarding this Agreement will be heard in the state or federal courts having jurisdiction in Suffolk County, Massachusetts, and Customer hereby submits to the personal jurisdiction and venue of such courts. The United Nations Convention on Contracts for the International Sale of Goods shall not apply to this Agreement and is expressly disclaimed.