



**Mallory Sonalert Products, Inc.**

Part #: **MSE14LDP2S**

**Sales Outline Drawing**

Revision: **C**

**Specifications:**

Sound Level Category	Loud
Mode of Operation	Multi-tone Grounded input
Voltage Rating	7 to 14 VDC
Frequency	3900 ± 500 Hz
Loudness @ 1 FT	85 to 95 dB(A) Typ.
Current Draw	50mA MAX
Housing Material	Valox (UL94V-0), Color: Black
Storage Temperature	-40° to +80° C
Operating Temperature	-40° to +65° C
Weight (Typical)	4.0g
Options	Please contact factory.

**Dimensions:** Inches (mm)

**ROHS Compliant**

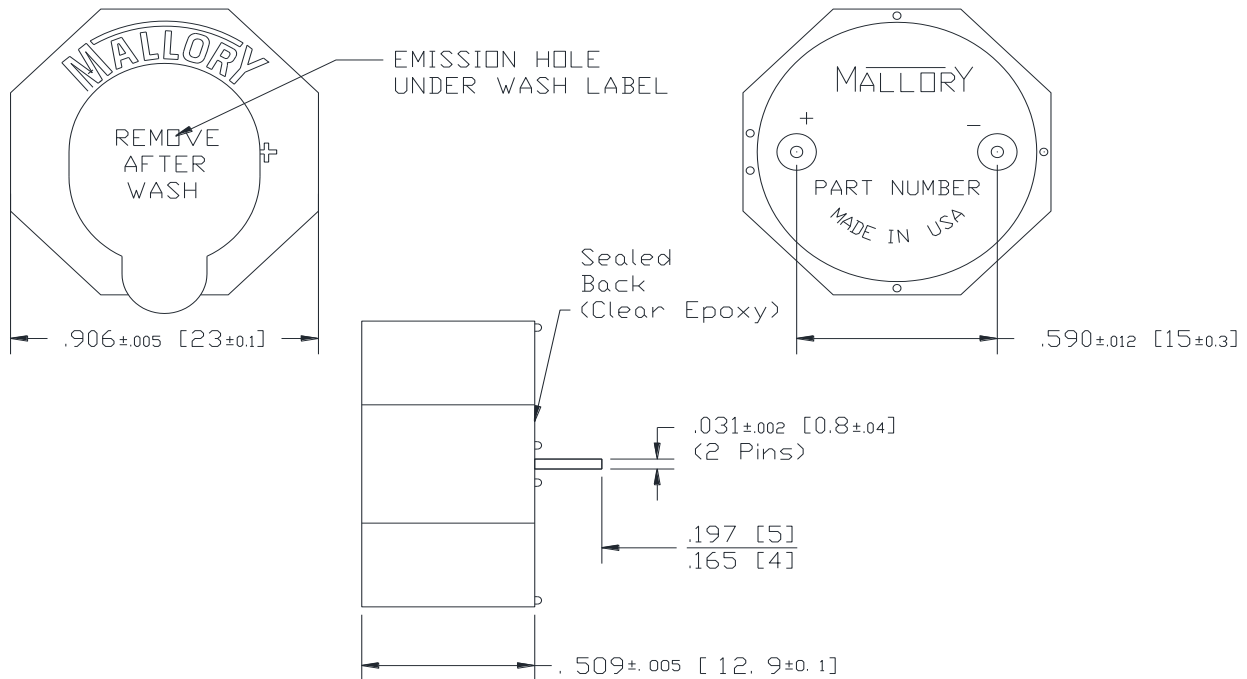

NOTE A:  
TERMINALS - .031" DIA. NICKEL/TIN COATED BRASS.

NOTE B:  
MOUNTING- INSERT INTO PRINTED CIRCUIT BOARD AND HAND OR MACHINE SOLDER. UNITS ARE SUITABLE FOR WAVE SOLDERING AND AQUEOUS WASH WHEN THE EMISSION HOLE IS COVERED WITH A WASH LABEL. RECOMMENDED MAXIMUM TEMPERATURE AND TIME DURATION FOR WAVE SOLDERING IS +270°C AND 3 SECONDS RESPECTIVELY.

NOTE C:  
PART NUMBER - FOR SEALED MODELS WHICH INCLUDE A WASH LABEL, THE PART NUMBER ENDS WITH THE SUFFIX "SR". THE LETTER "S" IS FOR ORDERING PURPOSES ONLY AND WILL NOT BE LISTED ON THE PART ITSELF.