

1

2

3

4

A

A

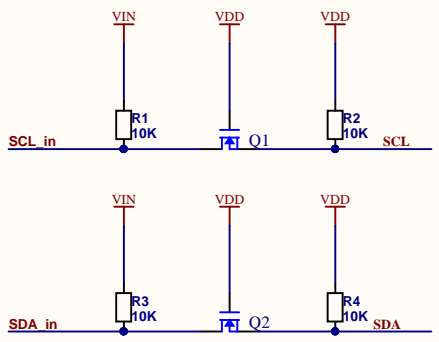
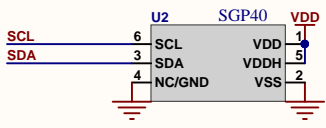
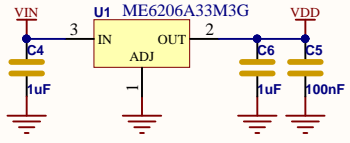
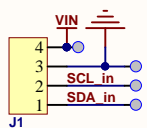

B

B

C

C



D

D

1

2

3

4



Title: Gravity SGP40 Air Quality Sensor	Code: SEN0394
Drawn: lfwag-CD	Revision: V1.0
Page: 1 of 1	Date: 2021/2/3
Size: A4	Time: 10:34:38

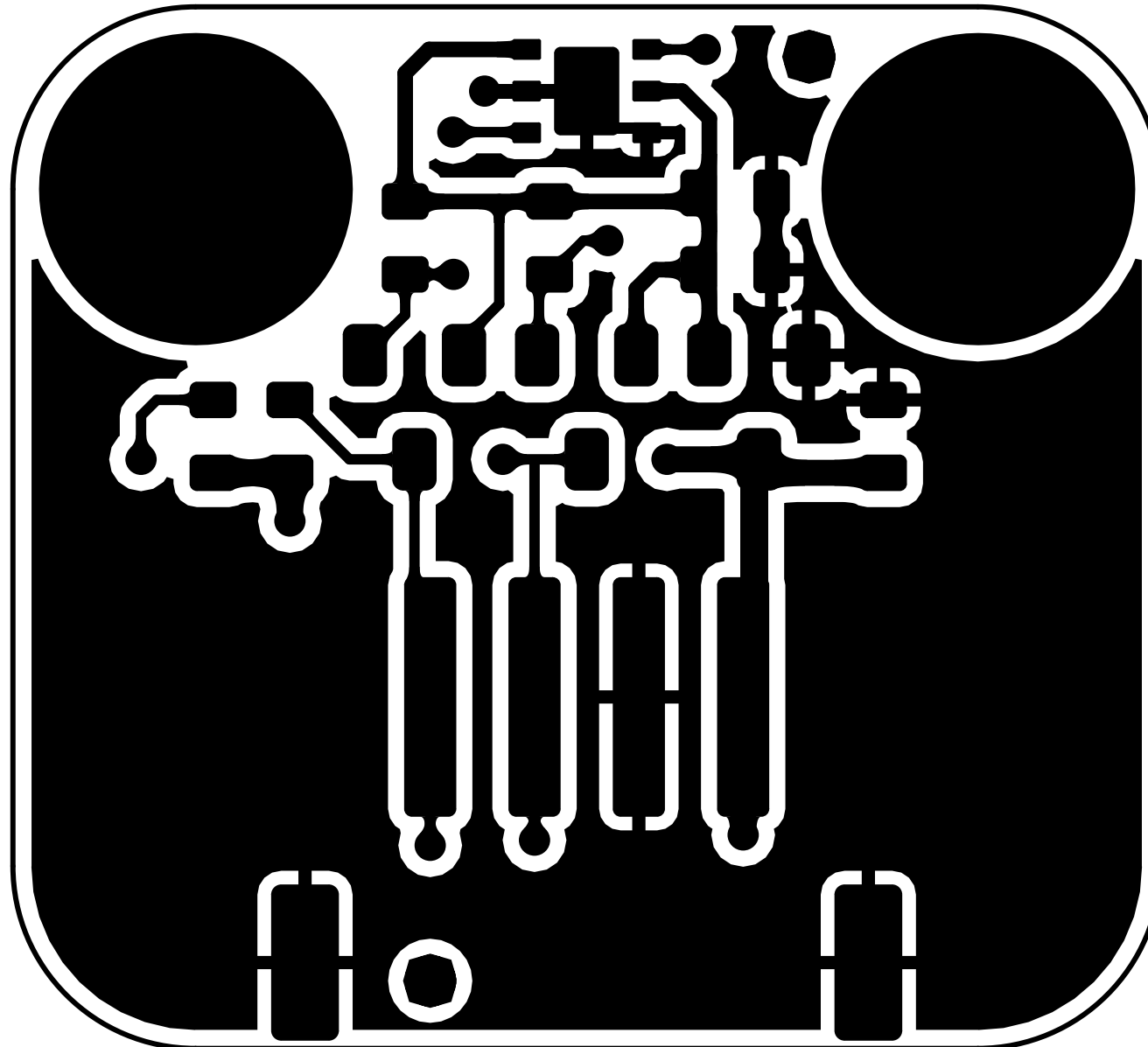

PCB Information	Name:SEN0394[V1.0]	Thickness: 1.0mm
Engineer:lfwag_CD	Top SolderMask: Black	Bottom SolderMask: Black
Date: 20210203	Top Silkscreen: White	Bottom Silkscreen: White

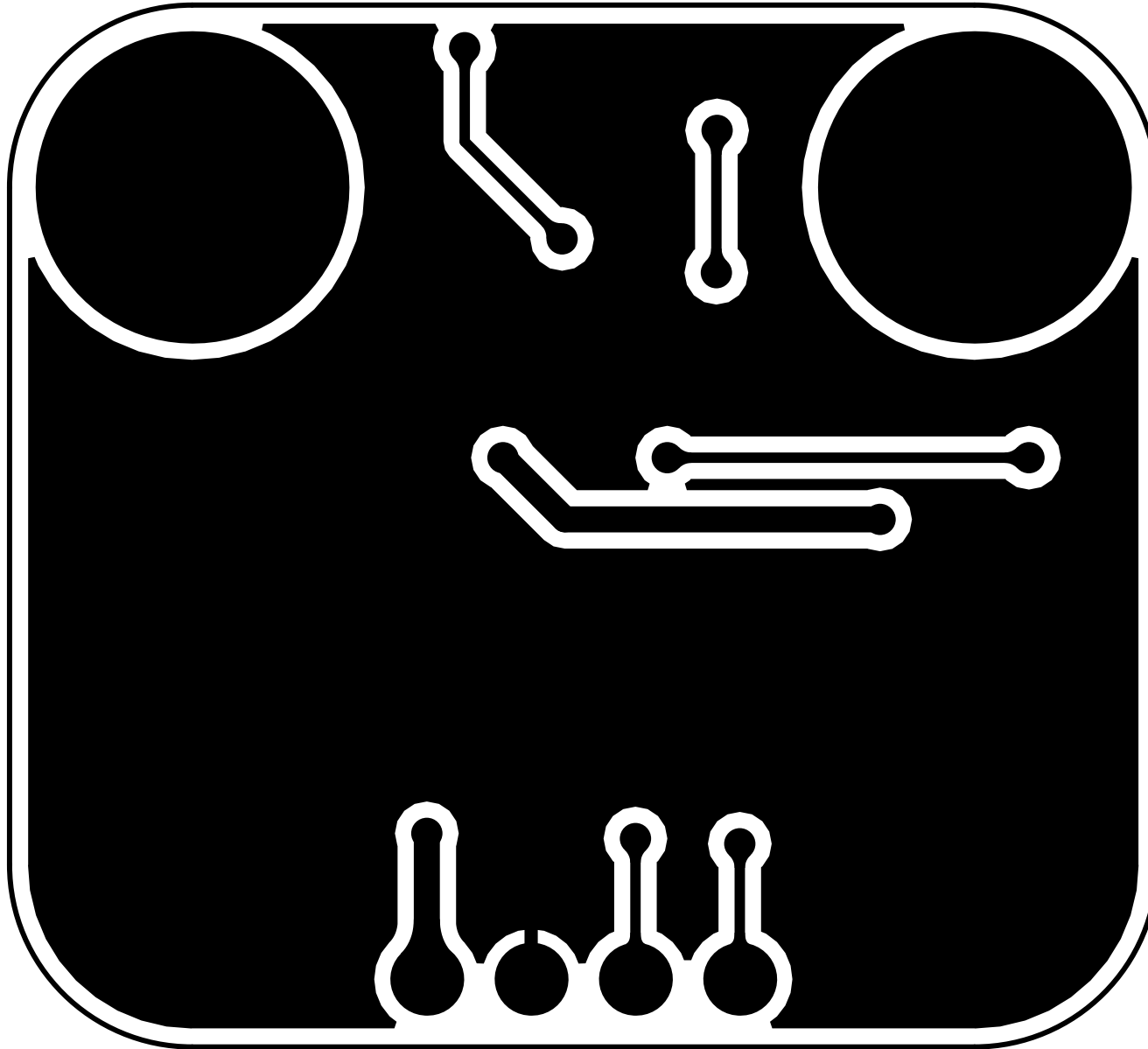

PCB Information	Name:SEN0394[V1.0]	Thickness: 1.0mm
Engineer:Ifwag_CD	Top SolderMask: Black	Bottom SolderMask: Black
Date: 20210203	Top Silkscreen: White	Bottom Silkscreen: White

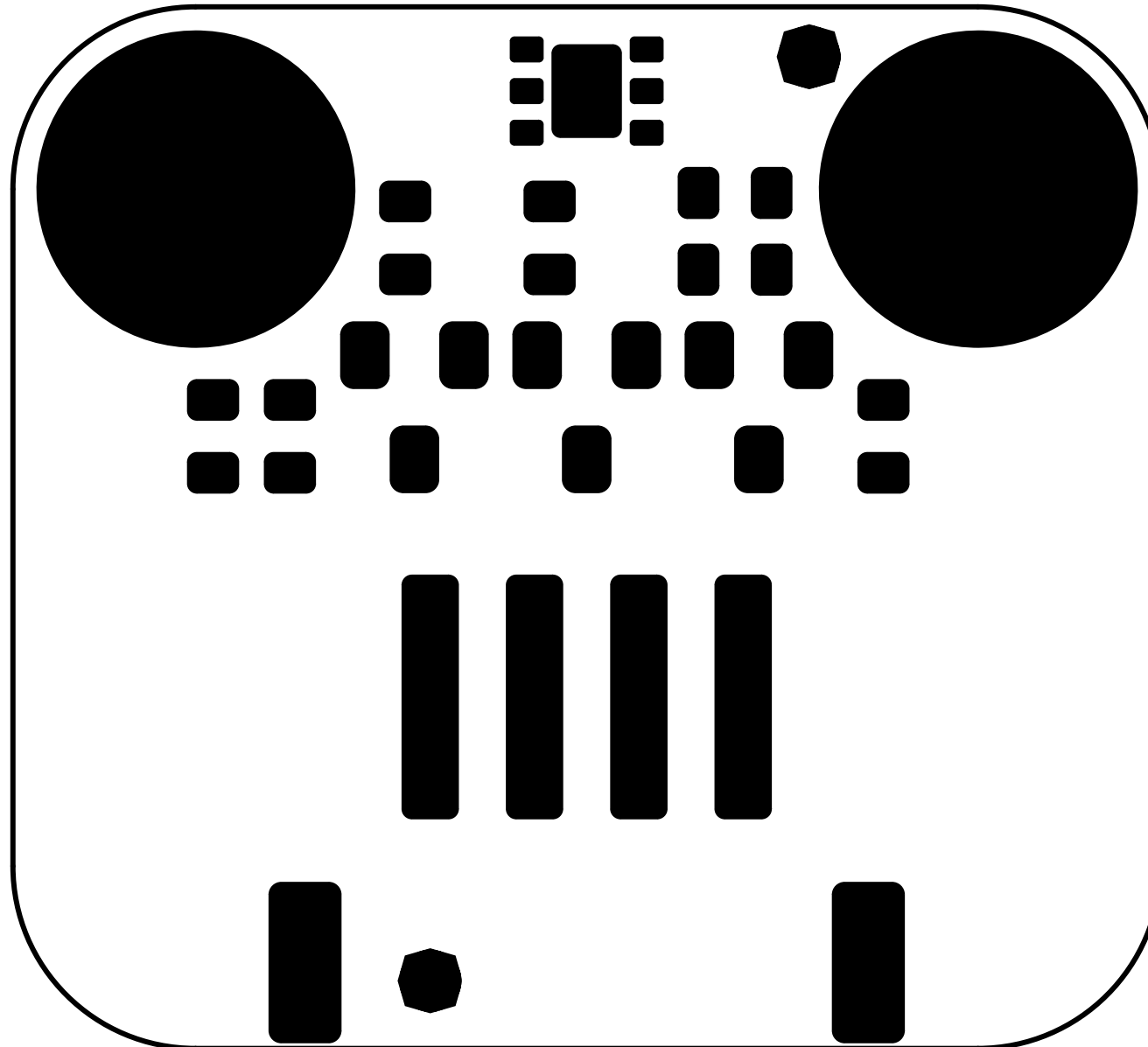

PCB Information	Name:SEN0394[V1.0]	Thickness: 1.0mm
Engineer:lfwag_CD	Top SolderMask: Black	Bottom SolderMask: Black
Date: 20210203	Top Silkscreen: White	Bottom Silkscreen: White

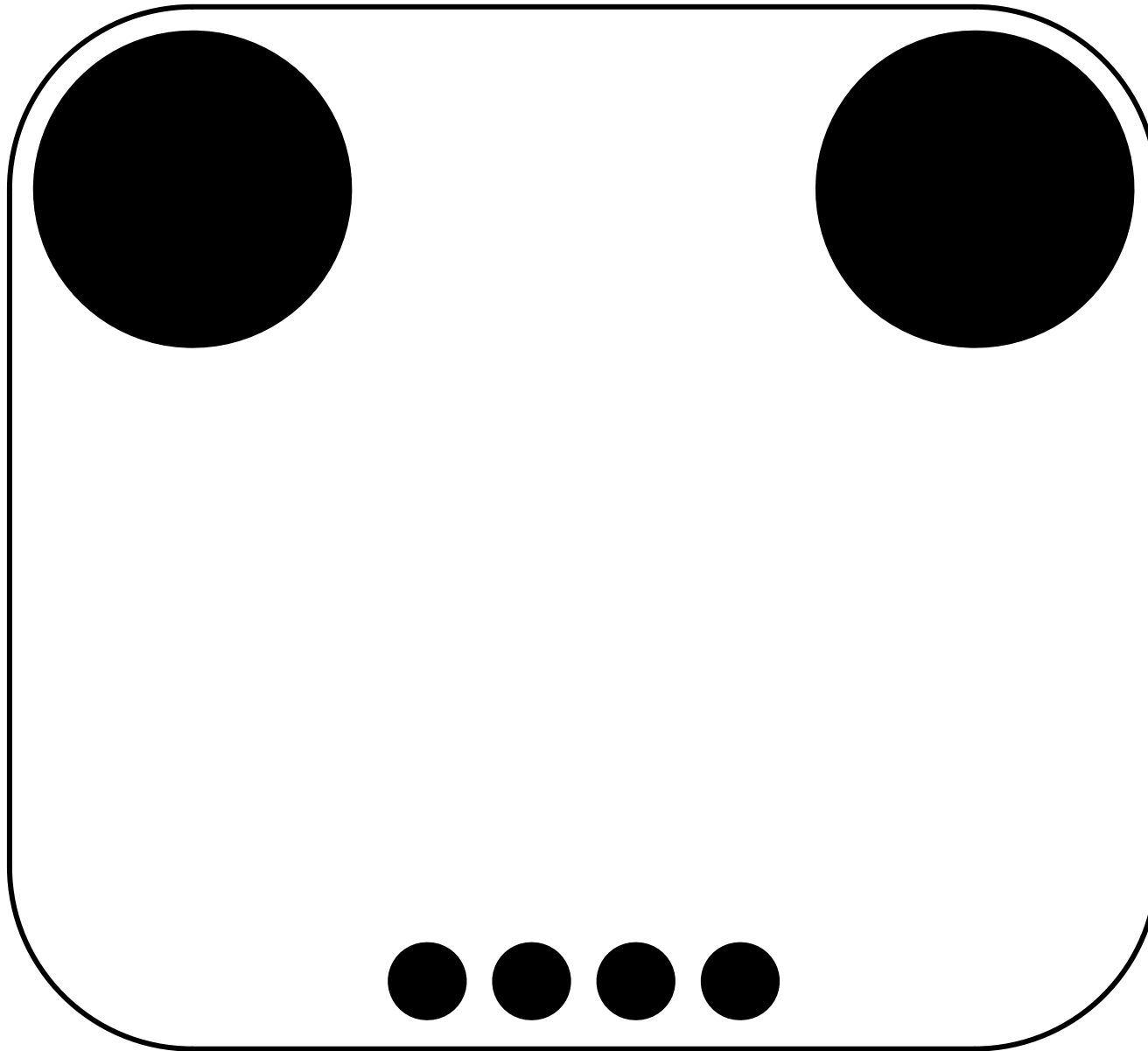

PCB Information	Name:SEN0394[V1.0]	Thickness: 1.0mm
Engineer:Ifwag_CD	Top SolderMask: Black	Bottom SolderMask: Black
Date: 20210203	Top Silkscreen: White	Bottom Silkscreen: White

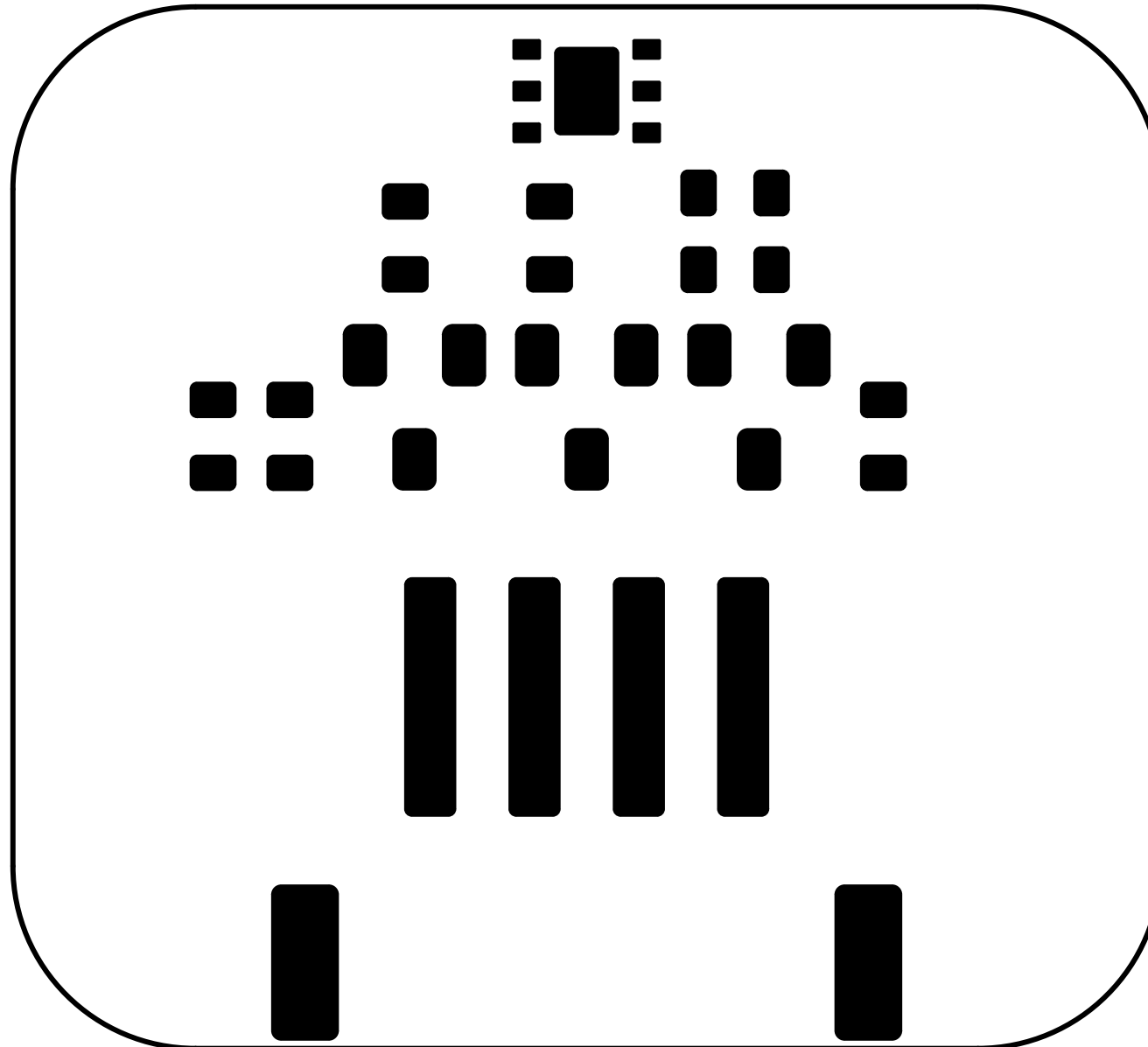

PCB Information	Name:SEN0394[V1.0]	Thickness: 1.0mm
Engineer:Ifwag_CD	Top SolderMask: Black	Bottom SolderMask: Black
Date: 20210203	Top Silkscreen: White	Bottom Silkscreen: White

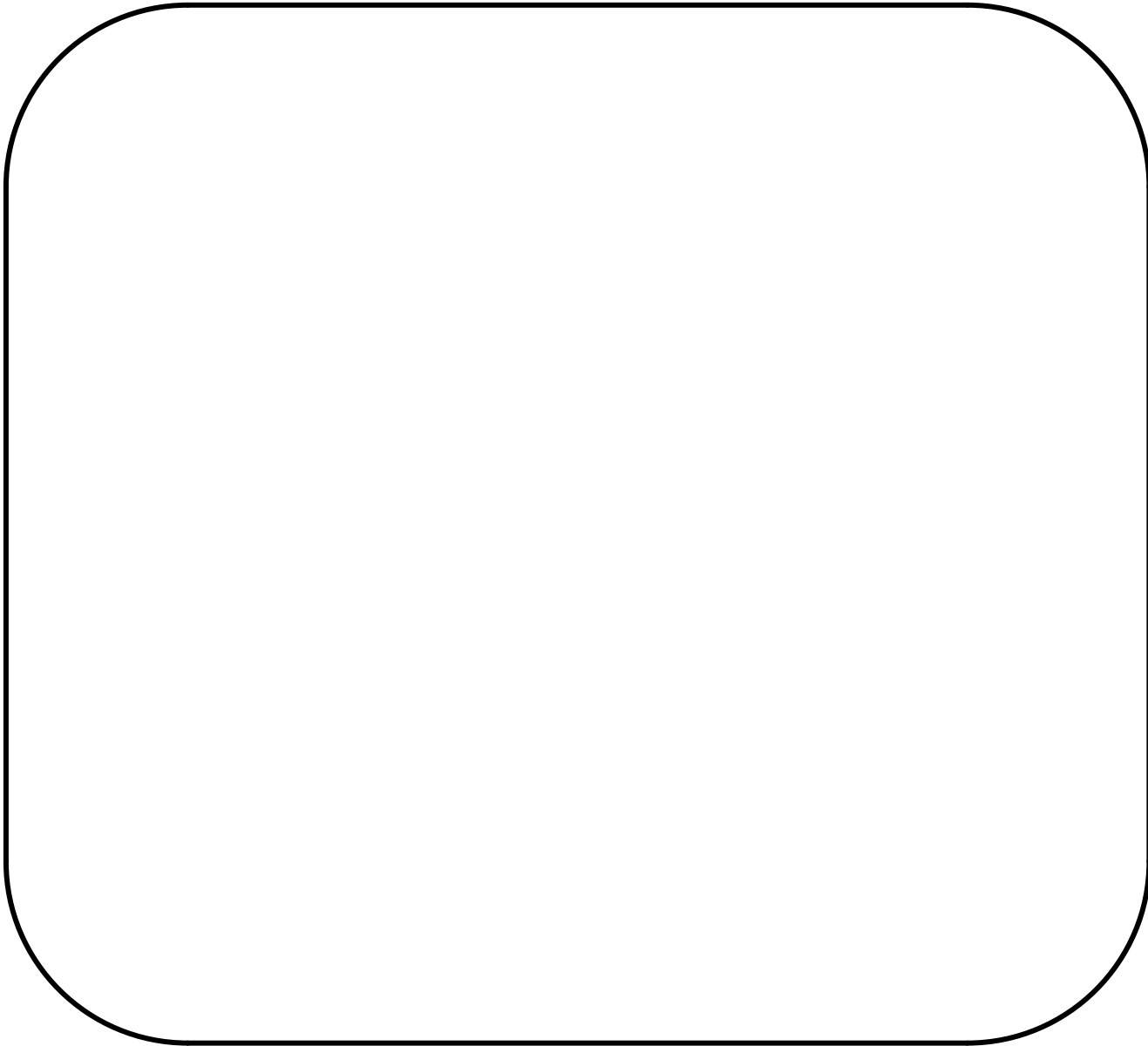

PCB Information	Name:SEN0394[V1.0]	Thickness: 1.0mm
Engineer:Ifwag_CD	Top SolderMask: Black	Bottom SolderMask: Black
Date: 20210203	Top Silkscreen: White	Bottom Silkscreen: White

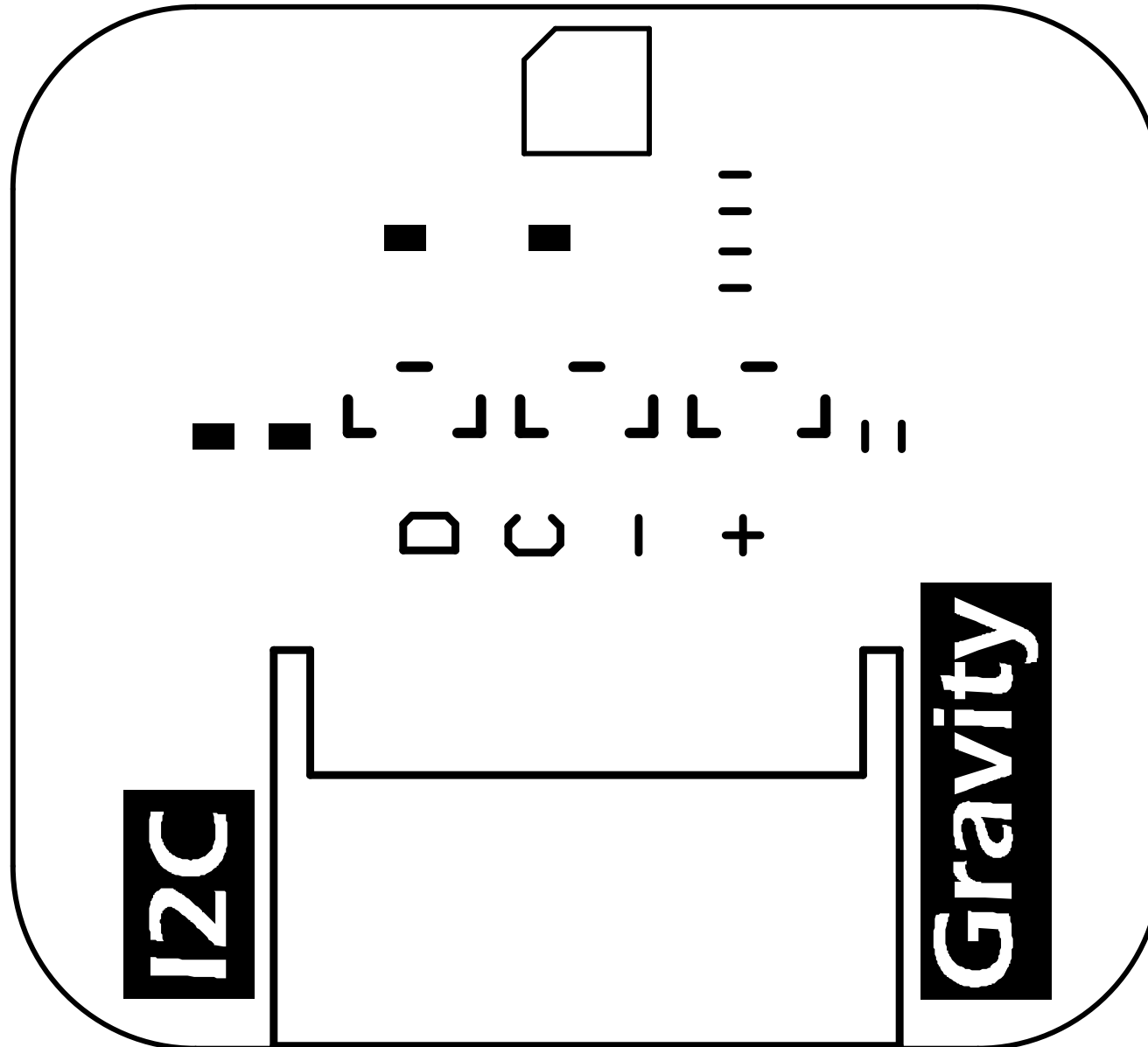

PCB Information	Name:SEN0394[V1.0]	Thickness: 1.0mm
Engineer:lfwag_CD	Top SolderMask: Black	Bottom SolderMask: Black
Date: 20210203	Top Silkscreen: White	Bottom Silkscreen: White

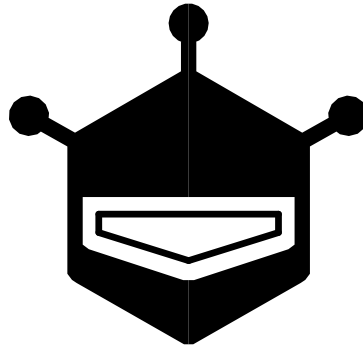

DFROBOT
SGP40 Air Quality Sensor
V1.0

PCB Information	Name:SEN0394[V1.0]	Thickness: 1.0mm
Engineer:Ifwag_CD	Top SolderMask: Black	Bottom SolderMask: Black
Date: 20210203	Top Silkscreen: White	Bottom Silkscreen: White

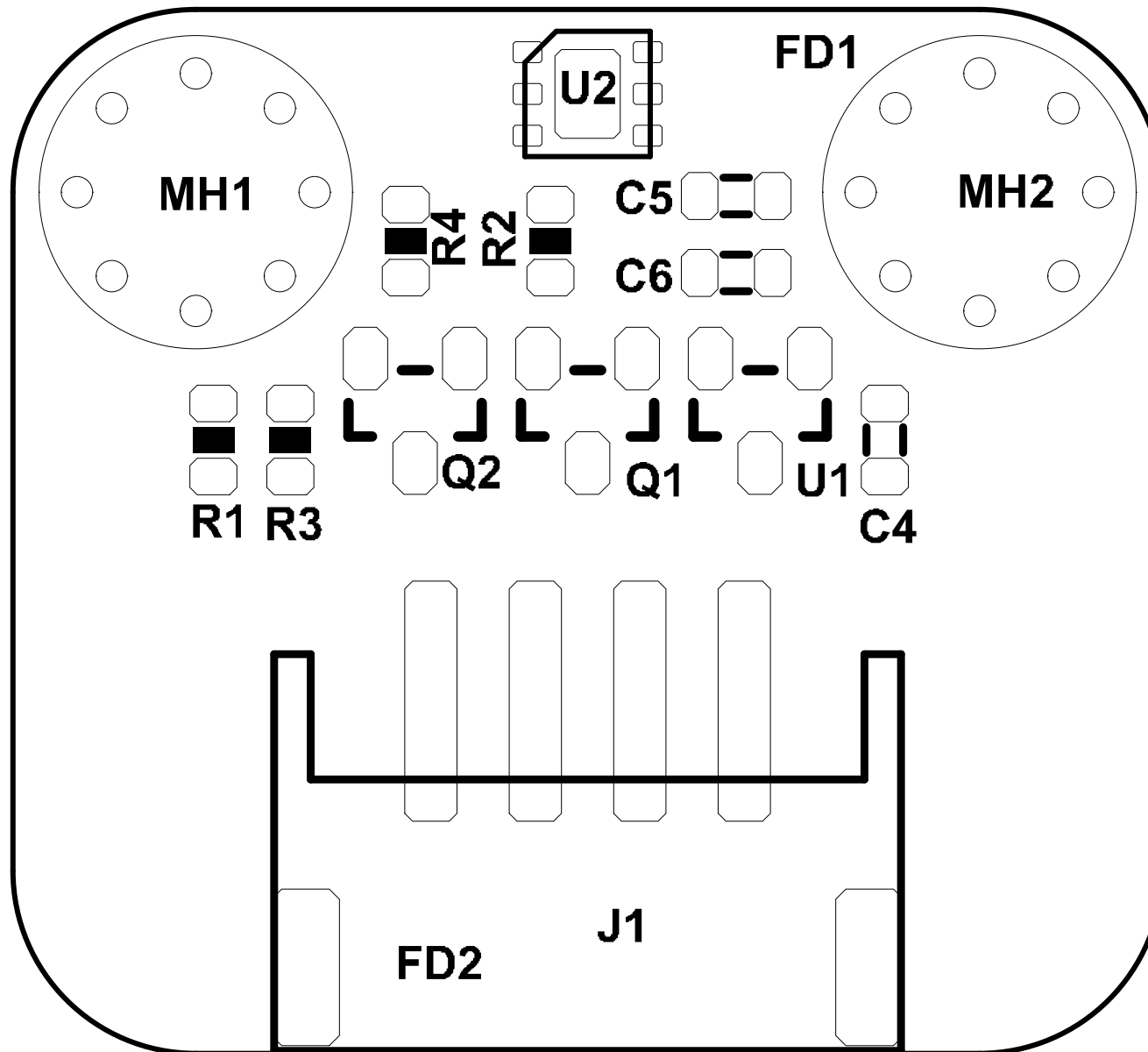

PCB Information	Name:SEN0394[V1.0]	Thickness: 1.0mm
Engineer:lfwag_CD	Top SolderMask: Black	Bottom SolderMask: Black
Date: 20210203	Top Silkscreen: White	Bottom Silkscreen: White

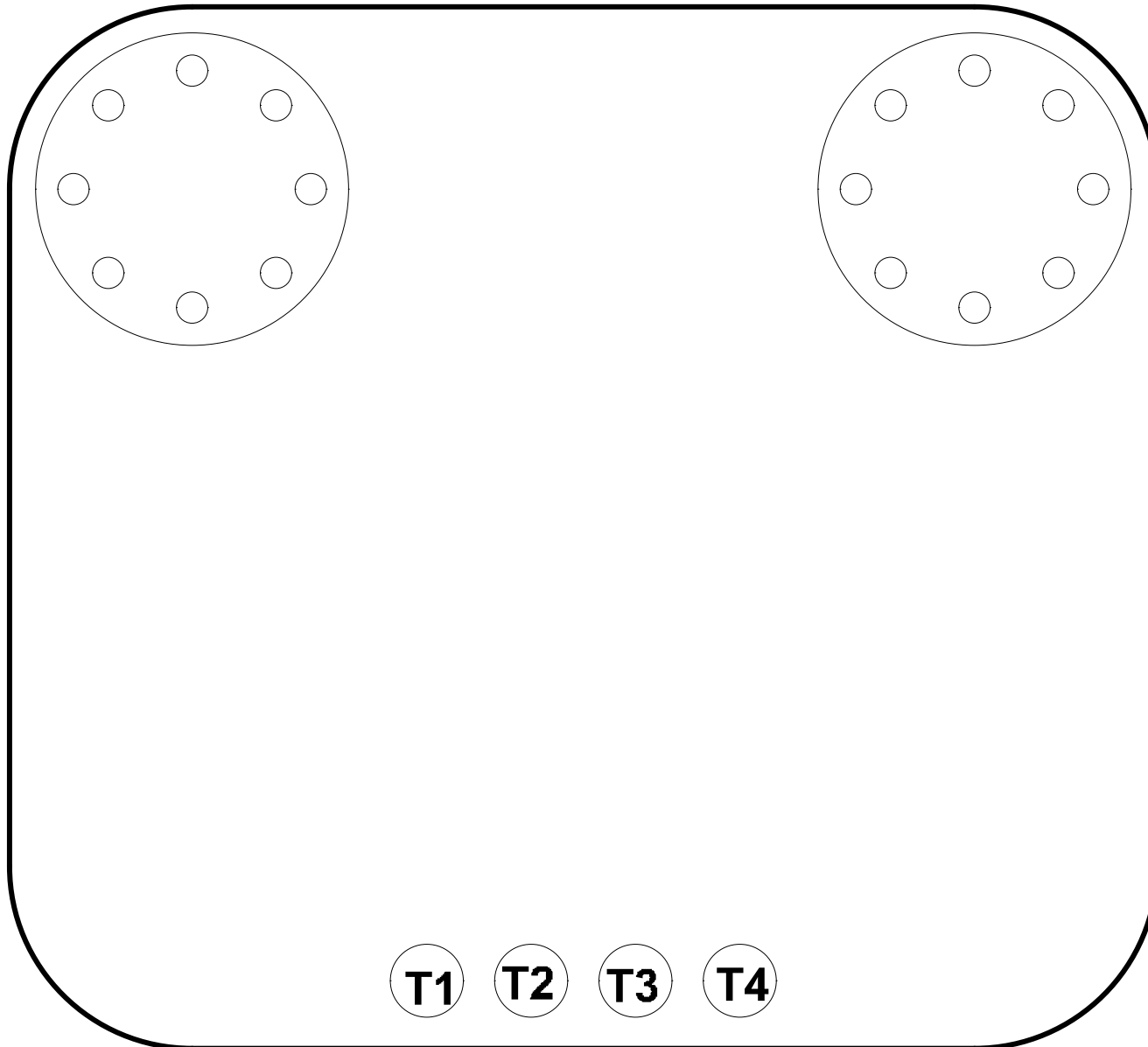

PCB Information	Name:SEN0394[V1.0]	Thickness: 1.0mm
Engineer:Ifwag_CD	Top SolderMask: Black	Bottom SolderMask: Black
Date: 20210203	Top Silkscreen: White	Bottom Silkscreen: White

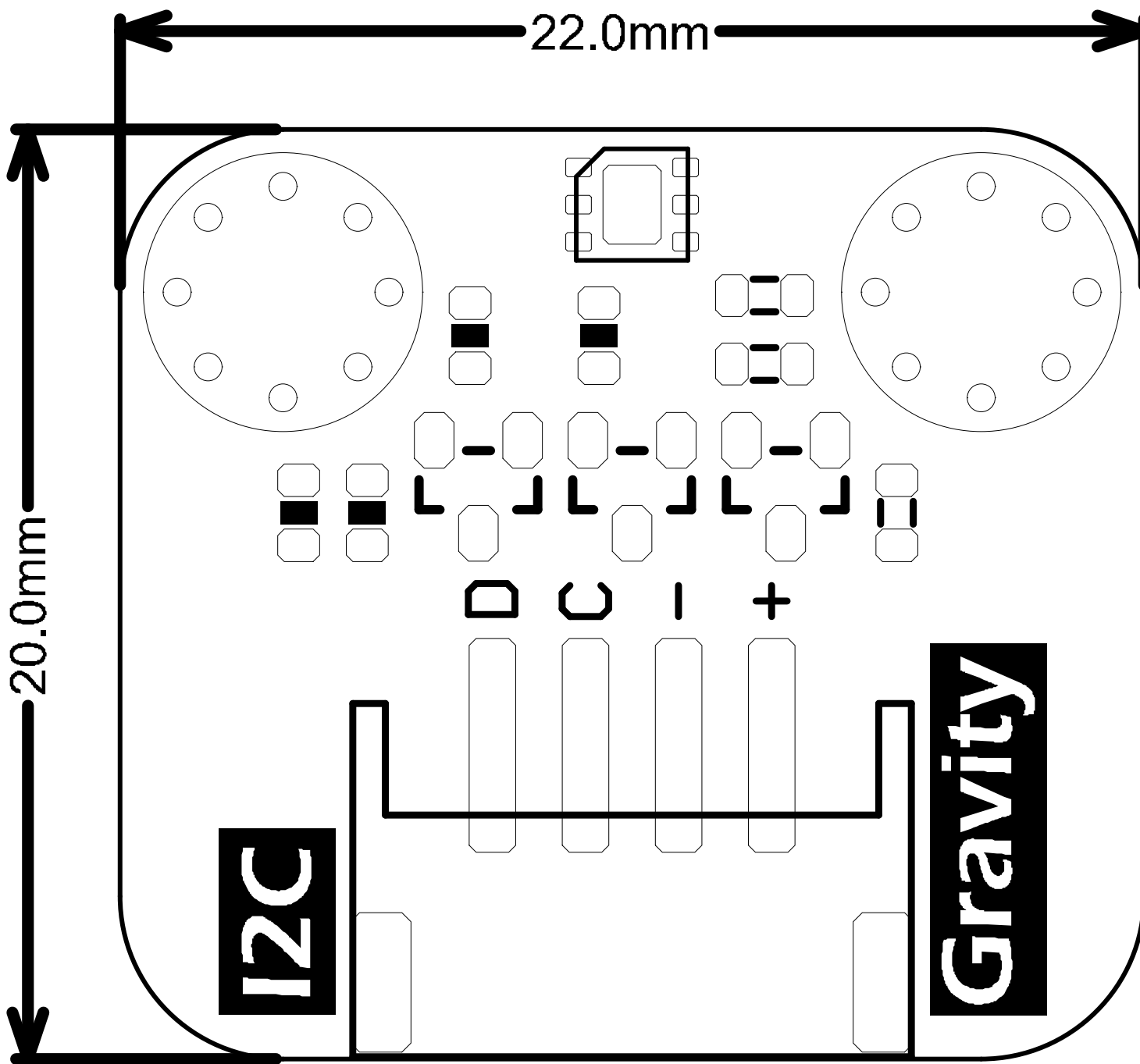

PCB Information	Name:SEN0394[V1.0]	Thickness: 1.0mm
Engineer:lfwag_CD	Top SolderMask: Black	Bottom SolderMask: Black
Date: 20210203	Top Silkscreen: White	Bottom Silkscreen: White

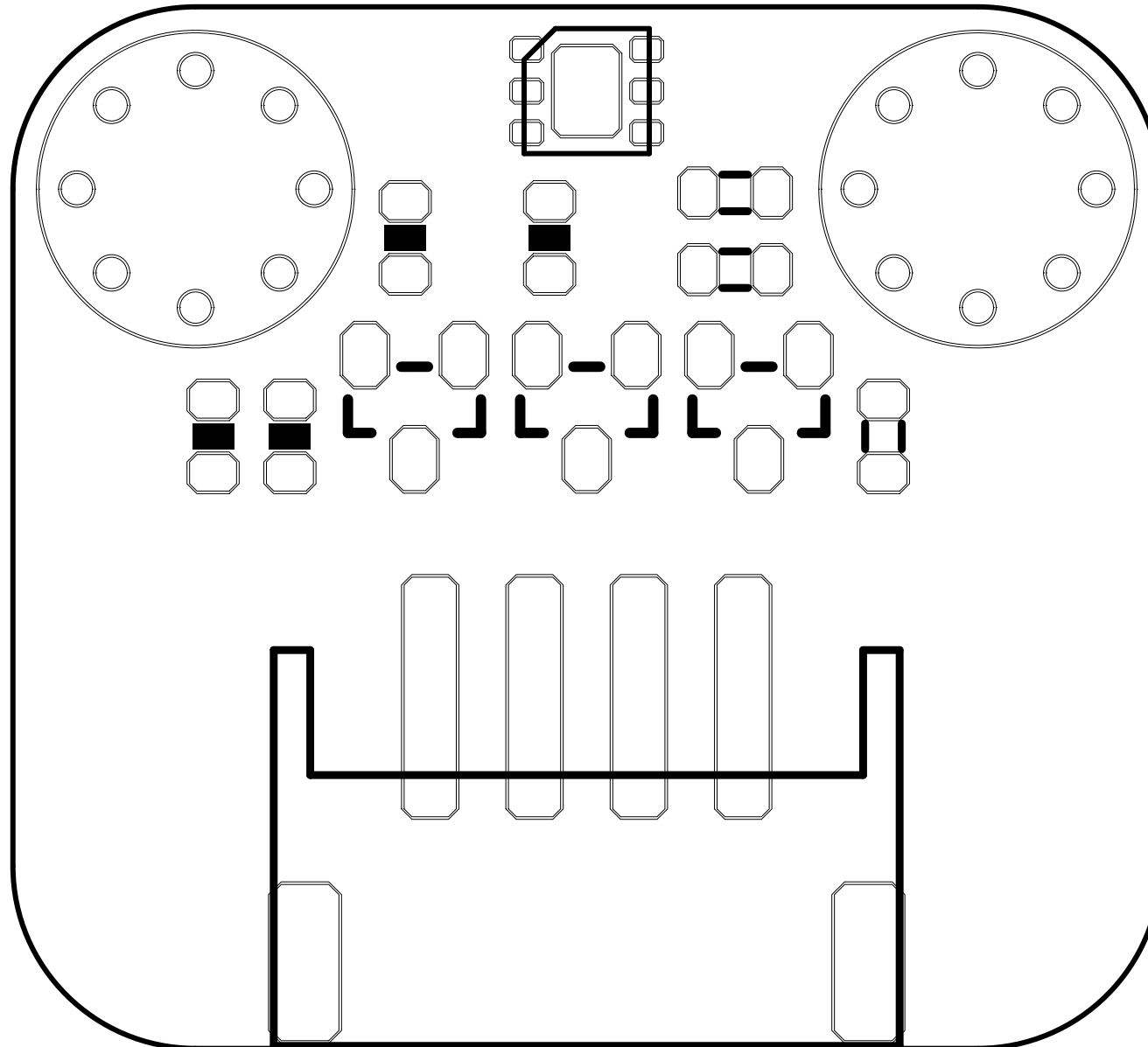

PCB Information	Name:SEN0394[V1.0]	Thickness: 1.0mm
Engineer:lfwag_CD	Top SolderMask: Black	Bottom SolderMask: Black
Date: 20210203	Top Silkscreen: White	Bottom Silkscreen: White

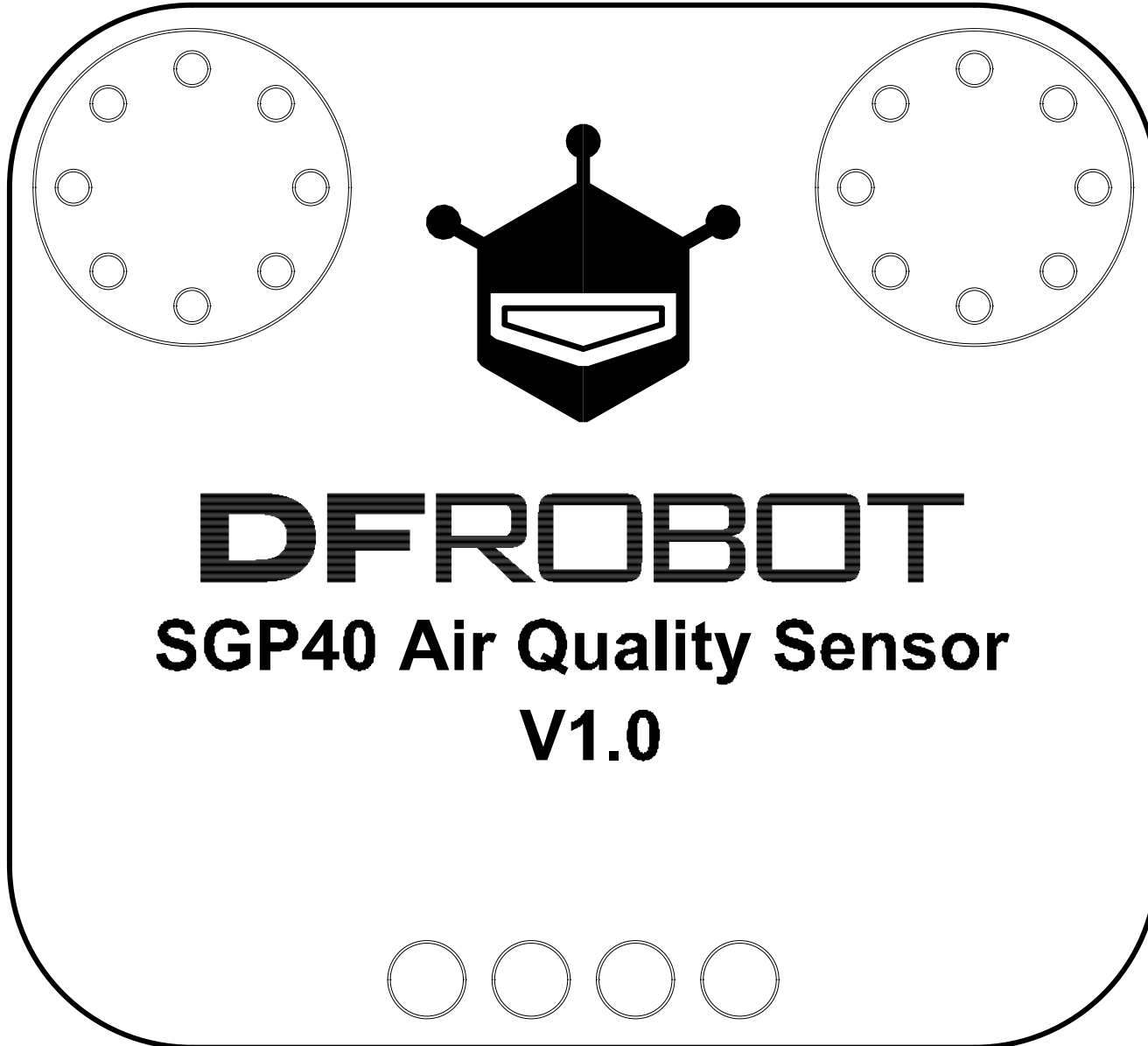

PCB Information	Name:SEN0394[V1.0]	Thickness: 1.0mm
Engineer:Ifwag_CD	Top SolderMask: Black	Bottom SolderMask: Black
Date: 20210203	Top Silkscreen: White	Bottom Silkscreen: White