

# REF1004

## 1.2V and 2.5V Micropower VOLTAGE REFERENCE

### FEATURES

- **INITIAL ACCURACY:**  
REF1004-1.2  $\pm 4\text{mV}$   
REF1004-2.5  $\pm 20\text{mV}$
- **MINIMUM OPERATING CURRENT:**  
REF1004-1.2  $10\mu\text{A}$   
REF1004-2.5  $20\mu\text{A}$
- **EXCELLENT LONG TERM TEMPERATURE STABILITY**
- **VERY LOW DYNAMIC IMPEDANCE**
- **OPERATES UP TO 20mA**
- **PACKAGE: 8-Lead SOIC**

### APPLICATIONS

- **BATTERY POWERED TEST EQUIPMENT**
- **PORTABLE MEDICAL INSTRUMENTATION**
- **PORTABLE COMMUNICATIONS DEVICES**
- **A/D AND D/A CONVERTERS**
- **NOTEBOOK AND PALMTOP COMPUTERS**

### DESCRIPTION

The REF1004-1.2 and REF1004-2.5 are two terminal bandgap reference diodes designed for high accuracy with outstanding temperature characteristics at low operating currents. Prior to the introduction of the REF1004 Micropower Voltage References, accuracy and stability specifications could only be attained by expensive screening of standard devices. The REF1004 is a cost effective solution when reference voltage accuracy, low power, and long term temperature stability are required.

REF1004 is a drop-in replacement for the LT1004 as well as an upgraded replacement of the LM185/385 series references. The REF1004C is characterized for operation from  $0^{\circ}\text{C}$  to  $70^{\circ}\text{C}$  and the REF1004I is characterized for operation from  $-40^{\circ}\text{C}$  to  $+85^{\circ}\text{C}$ .

The REF1004 is offered in an 8-lead Plastic SOIC package and shipped in anti-static rails or tape and reel.

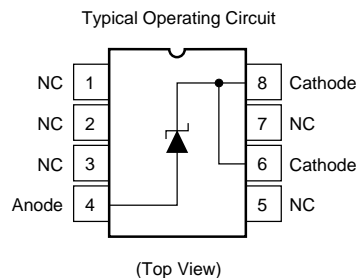

International Airport Industrial Park • Mailing Address: PO Box 11400 • Tucson, AZ 85734 • Street Address: 6730 S. Tucson Blvd. • Tucson, AZ 85706  
Tel: (520) 746-1111 • Twx: 910-952-1111 • Cable: BBRCORP • Telex: 066-6491 • FAX: (520) 889-1510 • Immediate Product Info: (800) 548-6132

# SPECIFICATIONS

## ELECTRICAL

T<sub>A</sub> = +25°C unless otherwise noted.

PARAMETER	CONDITIONS	REF1004-1.2			REF1004-2.5			UNITS
		MIN	TYP	MAX	MIN	TYP	MAX	
REFERENCE VOLTAGE REF1004C <sup>(1)</sup> REF1004I <sup>(2)</sup>	I <sub>R</sub> = 100μA	1.231 1.229 1.225	1.235 1.235 1.235	1.239 1.239 1.239	2.490 2.487 2.480	2.500 2.500 2.500	2.511 2.511 2.511	V
AVERAGE TEMPERATURE COEFFICIENT	I <sub>MIN</sub> ≤ I <sub>R</sub> ≤ 20mA		20			20		ppm/°C
MINIMUM OPERATION CURRENT <sup>(3)</sup>			8	10		12	20	μA
REVERSE BREAKDOWN VOLTAGE CHANGE WITH CURRENT	I <sub>MIN</sub> ≤ I <sub>R</sub> ≤ 1mA 1mA ≤ I <sub>R</sub> ≤ 20mA			1 1.5 <sup>(3)</sup> 10 20 <sup>(3)</sup>			1 1.5 <sup>(3)</sup> 10 20 <sup>(3)</sup>	mV
REVERSE DYNAMIC IMPEDANCE <sup>(3)</sup>	I <sub>R</sub> = 100μA		0.2	0.6		0.2	0.6	Ω
WIDE BAND NOISE (RMS) 10Hz ≤ I <sub>R</sub> ≤ 10kHz	I <sub>R</sub> = 100μA		60			120		μV
LONG TERM STABILITY T <sub>A</sub> = 25°C ± 0.1°C	I <sub>R</sub> = 100μA		20			20		ppm/KHr

NOTES: (1) This specification applies over the full operating temperature range of 0°C ≤ T<sub>A</sub> ≤ 70°C. (2) This specification applies over the full operating temperature range of 40°C ≤ T<sub>A</sub> ≤ +85°C. (3) Denotes the specifications which apply over the full operating temperature range.

## ORDERING INFORMATION

MODEL	T <sub>A</sub>	V <sub>Z</sub>	PACKAGE
REF1004C-1.2	0°C to +70°C	1.2V	8-Lead SOIC
REF1004C-2.5	0°C to +70°C	2.5V	8-Lead SOIC
REF1004I-1.2	-40°C to +85°C	1.2V	8-Lead SOIC
REF1004I-2.5	-40°C to +85°C	2.5V	8-Lead SOIC

NOTE: Available in Tape and Reel, Add -TR to Model Number.

## ABSOLUTE MAXIMUM RATINGS

Reverse Breakdown Current	30mA
Forward Current	10mA
Operating Temperature Range	
REF1004C	0°C to +70°C
REF1004I	-40°C to +85°C
Storage Temperature	
REF1004C	-65°C to +150°C
REF1004I	-65°C to +150°C
Lead Temperature (soldering, 10s)	+300°C

## ORDERING INFORMATION

MODEL	PART MARKING
REF1004C-1.2	BBREF0412
REF1004C-2.5	BBREF0425
REF1004I-1.2	BBREF0412
REF1004I-2.5	BBREF0425

## PACKAGE INFORMATION

MODEL	PACKAGE	PACKAGE DRAWING NUMBER <sup>(1)</sup>
REF1004C-1.2	8-Pin SOIC	182
REF1004C-2.5	8-Pin SOIC	182
REF1004I-1.2	8-Pin SOIC	182
REF1004I-2.5	8-Pin SOIC	182

NOTE: (1) For detailed drawing and dimension table, please see end of data sheet, or Appendix D of Burr-Brown IC Data Book.

The information provided herein is believed to be reliable; however, BURR-BROWN assumes no responsibility for inaccuracies or omissions. BURR-BROWN assumes no responsibility for the use of this information, and all use of such information shall be entirely at the user's own risk. Prices and specifications are subject to change without notice. No patent rights or licenses to any of the circuits described herein are implied or granted to any third party. BURR-BROWN does not authorize or warrant any BURR-BROWN product for use in life support devices and/or systems.



REF1004

# TYPICAL PERFORMANCE CURVES 1.2V

$T_A = +25^\circ\text{C}$  unless otherwise noted.

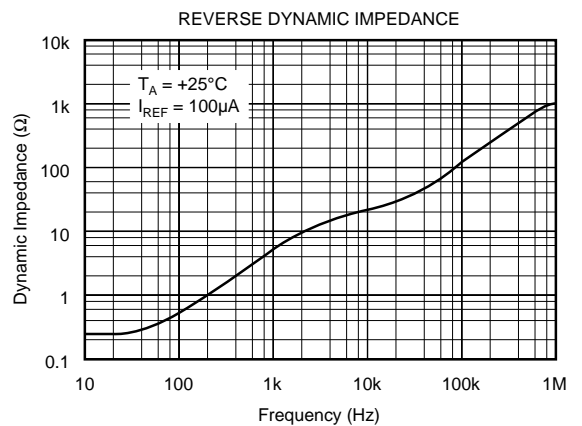
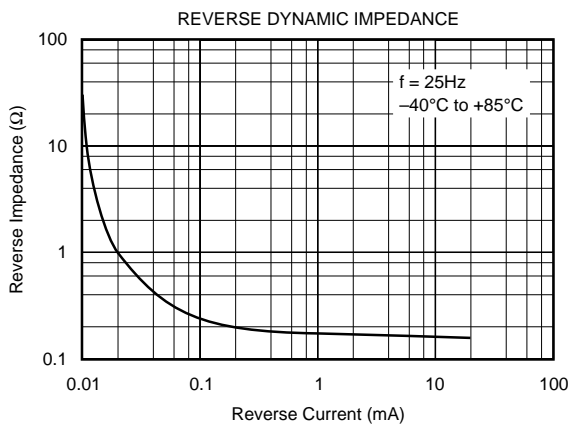
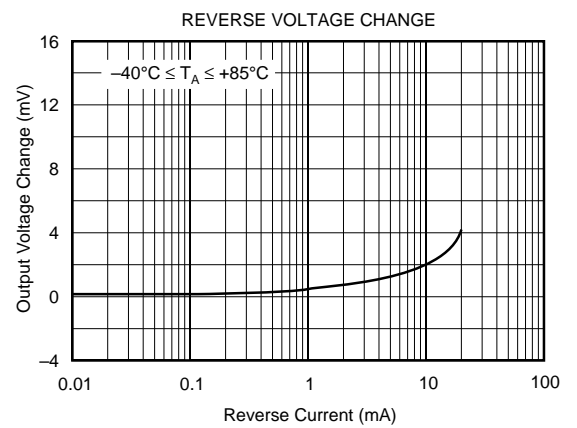
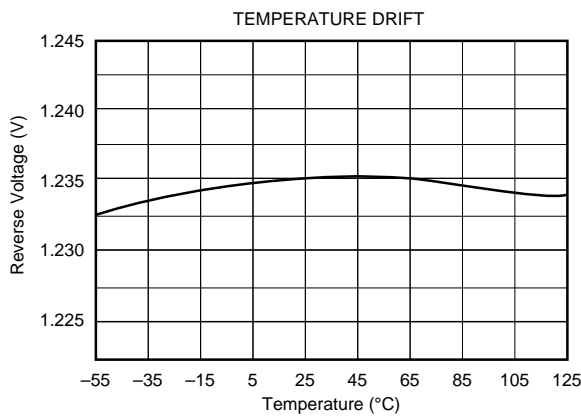
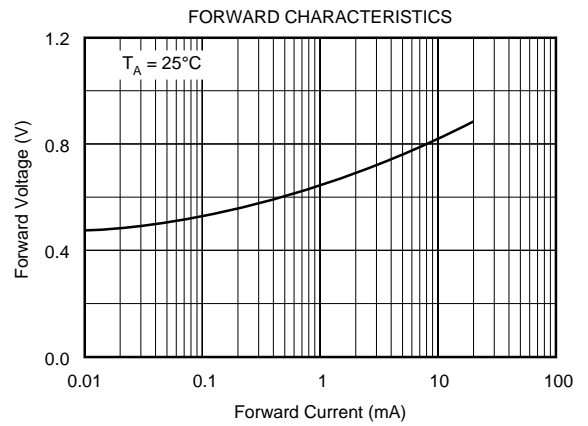
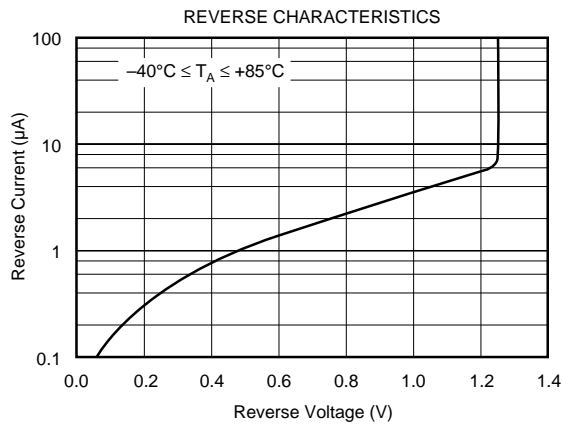

# TYPICAL PERFORMANCE CURVES 1.2V (CONT)

$T_A = +25^\circ\text{C}$  unless otherwise noted.

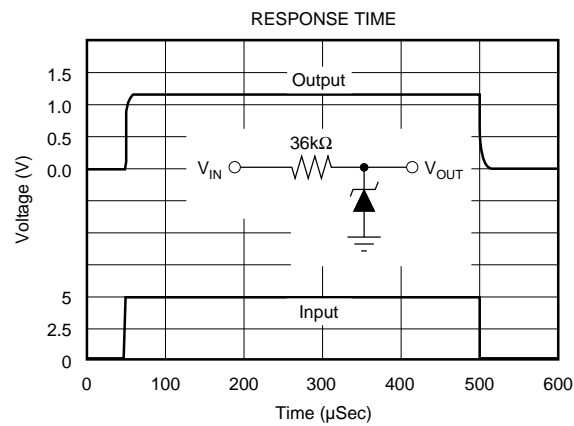
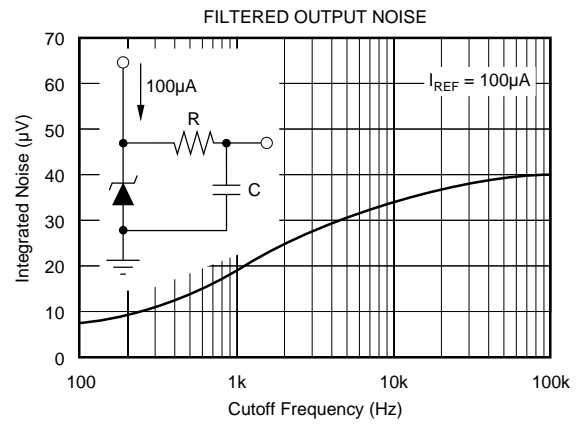
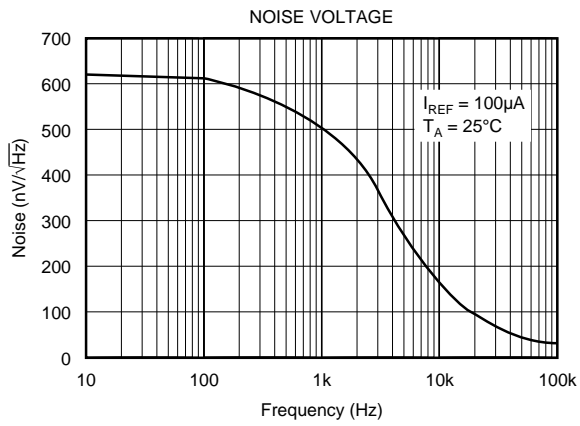

# TYPICAL PERFORMANCE CURVES 2.5V

$T_A = +25^\circ\text{C}$  unless otherwise noted.

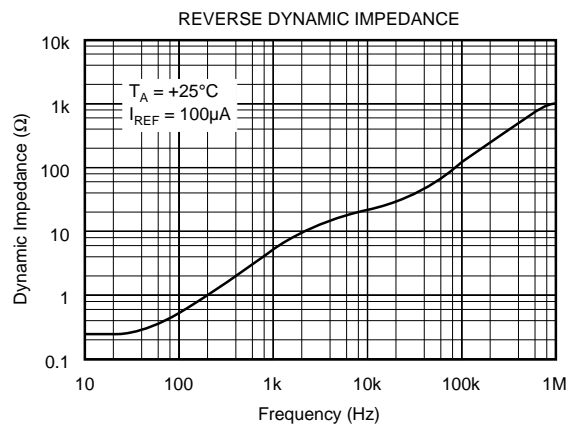
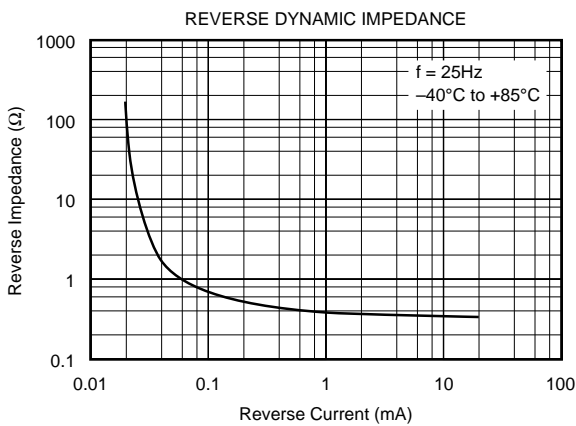
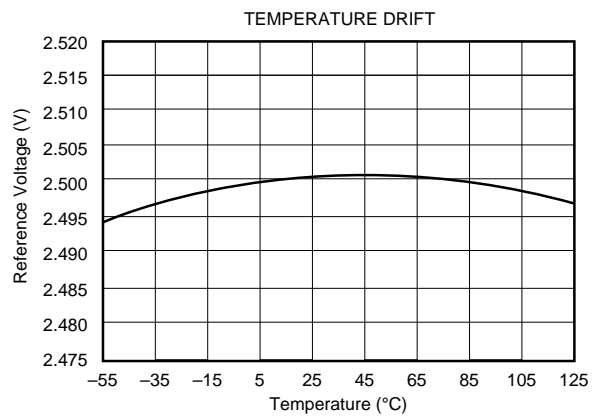
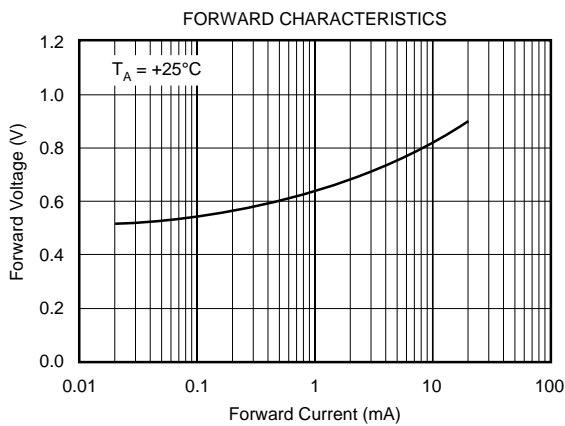
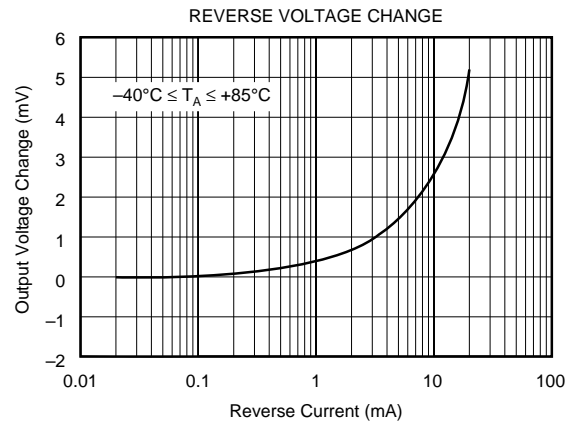
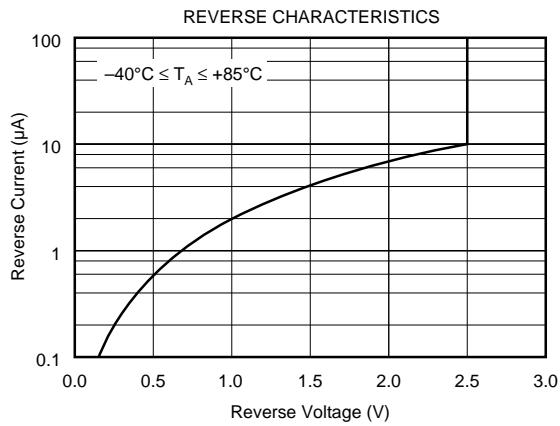

# TYPICAL PERFORMANCE CURVES 2.5V (CONT)

T<sub>A</sub> = +25°C unless otherwise noted.

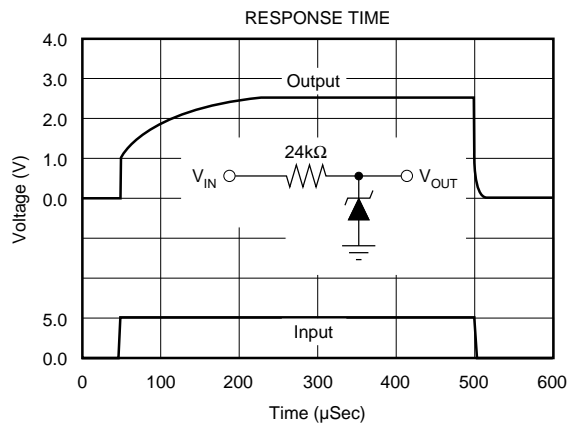
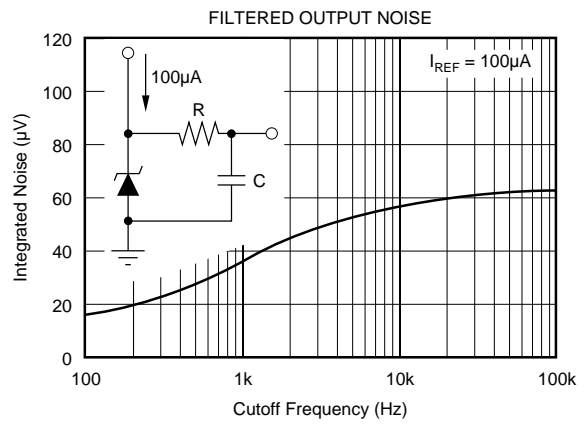
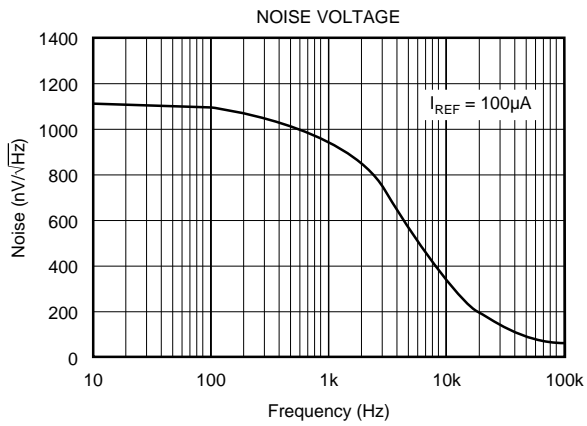

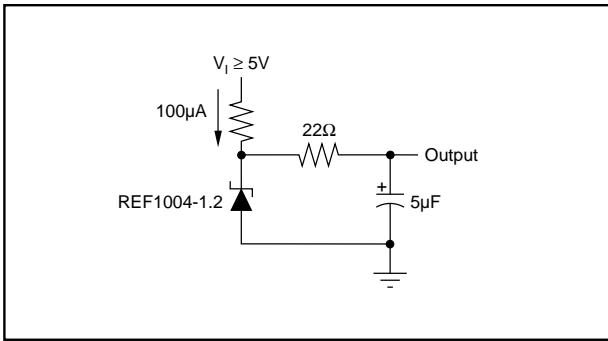

FIGURE 1. Low-Noise Reference.

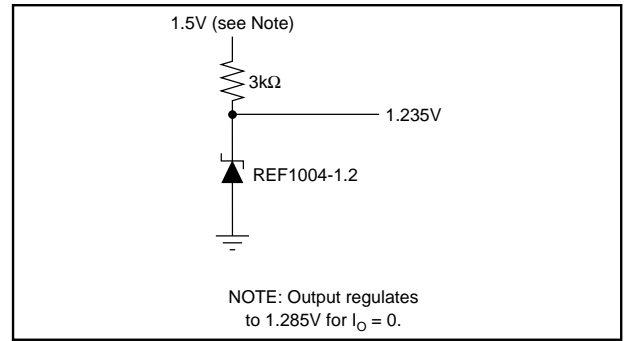

FIGURE 3. 1.2V Reference from 1.5V Battery.

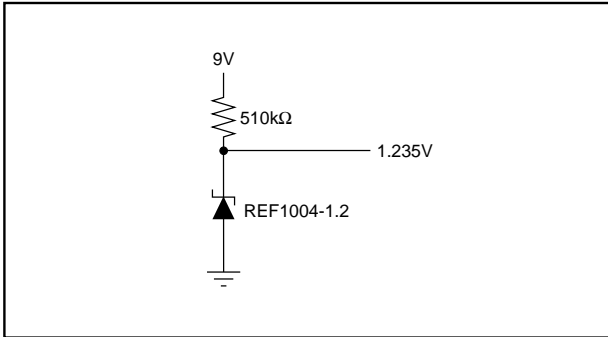

FIGURE 2. Micropower Reference from 9V Battery.

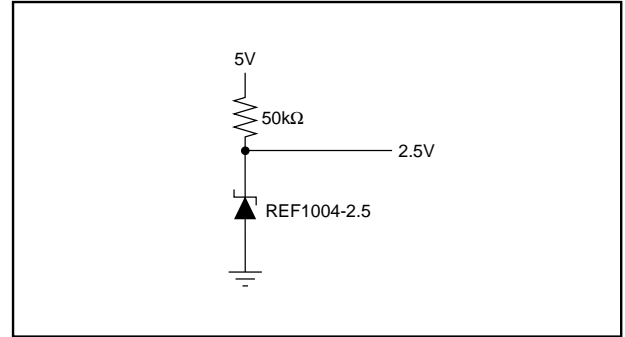

FIGURE 4. 2.5V Reference.

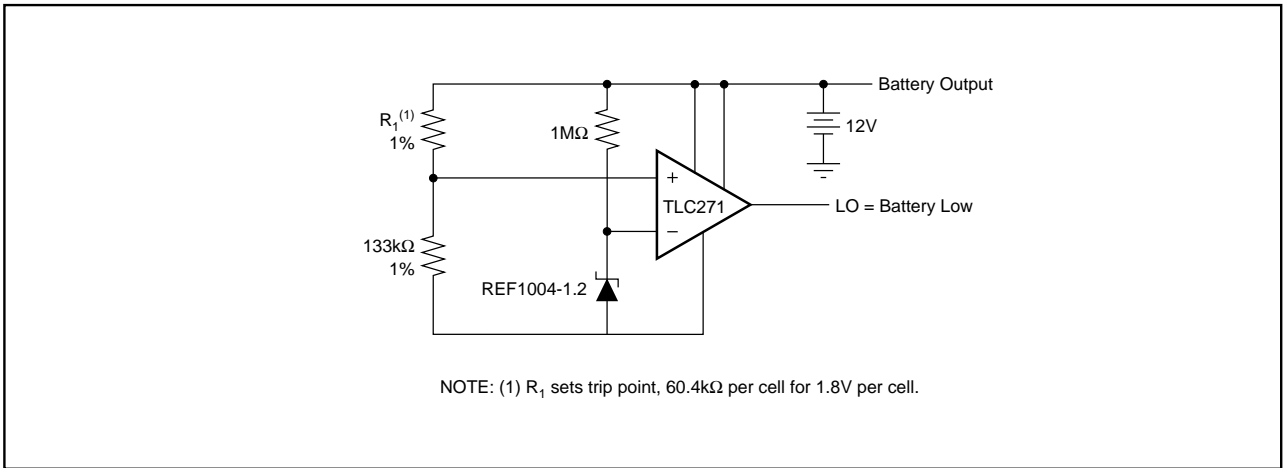

FIGURE 5. Lead-Acid Low-Battery-Voltage Detector.

**PACKAGING INFORMATION**

Orderable Device	Status (1)	Package Type	Package Drawing	Pins	Package Qty	Eco Plan (2)	Lead finish/ Ball material (6)	MSL Peak Temp (3)	Op Temp (°C)	Device Marking (4/5)	Samples
REF1004C-1.2	ACTIVE	SOIC	D	8	75	RoHS & Green	NIPDAU	Level-3-260C-168 HR	0 to 70	REF 0412	<a href="#">Samples</a>
REF1004C-1.2/2K5	ACTIVE	SOIC	D	8	2500	RoHS & Green	NIPDAU	Level-3-260C-168 HR	0 to 70	REF 0412	<a href="#">Samples</a>
REF1004C-2.5	ACTIVE	SOIC	D	8	75	RoHS & Green	NIPDAU	Level-3-260C-168 HR	0 to 70	REF 0425	<a href="#">Samples</a>
REF1004C-2.5/2K5	ACTIVE	SOIC	D	8	2500	RoHS & Green	NIPDAU	Level-3-260C-168 HR	0 to 70	REF 0425	<a href="#">Samples</a>
REF1004I-1.2	ACTIVE	SOIC	D	8	75	RoHS & Green	NIPDAU	Level-3-260C-168 HR	-40 to 85	REF 0412	<a href="#">Samples</a>
REF1004I-1.2/2K5	ACTIVE	SOIC	D	8	2500	RoHS & Green	NIPDAU	Level-3-260C-168 HR	-40 to 85	REF 0412	<a href="#">Samples</a>
REF1004I-1.2E4	ACTIVE	SOIC	D	8	75	RoHS & Green	NIPDAU	Level-3-260C-168 HR	-40 to 85	REF 0412	<a href="#">Samples</a>
REF1004I-2.5	ACTIVE	SOIC	D	8	75	RoHS & Green	NIPDAU	Level-3-260C-168 HR	-40 to 85	REF 0425	<a href="#">Samples</a>
REF1004I-2.5/2K5	ACTIVE	SOIC	D	8	2500	RoHS & Green	NIPDAU	Level-3-260C-168 HR	-40 to 85	REF 0425	<a href="#">Samples</a>

(1) The marketing status values are defined as follows:

**ACTIVE:** Product device recommended for new designs.

**LIFEBUY:** TI has announced that the device will be discontinued, and a lifetime-buy period is in effect.

**NRND:** Not recommended for new designs. Device is in production to support existing customers, but TI does not recommend using this part in a new design.

**PREVIEW:** Device has been announced but is not in production. Samples may or may not be available.

**OBSELETE:** TI has discontinued the production of the device.

(2) **RoHS:** TI defines "RoHS" to mean semiconductor products that are compliant with the current EU RoHS requirements for all 10 RoHS substances, including the requirement that RoHS substance do not exceed 0.1% by weight in homogeneous materials. Where designed to be soldered at high temperatures, "RoHS" products are suitable for use in specified lead-free processes. TI may reference these types of products as "Pb-Free".

**RoHS Exempt:** TI defines "RoHS Exempt" to mean products that contain lead but are compliant with EU RoHS pursuant to a specific EU RoHS exemption.

**Green:** TI defines "Green" to mean the content of Chlorine (Cl) and Bromine (Br) based flame retardants meet JS709B low halogen requirements of <=1000ppm threshold. Antimony trioxide based flame retardants must also meet the <=1000ppm threshold requirement.

(3) MSL, Peak Temp. - The Moisture Sensitivity Level rating according to the JEDEC industry standard classifications, and peak solder temperature.



- (4) There may be additional marking, which relates to the logo, the lot trace code information, or the environmental category on the device.
- (5) Multiple Device Markings will be inside parentheses. Only one Device Marking contained in parentheses and separated by a "~" will appear on a device. If a line is indented then it is a continuation of the previous line and the two combined represent the entire Device Marking for that device.
- (6) Lead finish/Ball material - Orderable Devices may have multiple material finish options. Finish options are separated by a vertical ruled line. Lead finish/Ball material values may wrap to two lines if the finish value exceeds the maximum column width.

**Important Information and Disclaimer:**The information provided on this page represents TI's knowledge and belief as of the date that it is provided. TI bases its knowledge and belief on information provided by third parties, and makes no representation or warranty as to the accuracy of such information. Efforts are underway to better integrate information from third parties. TI has taken and continues to take reasonable steps to provide representative and accurate information but may not have conducted destructive testing or chemical analysis on incoming materials and chemicals. TI and TI suppliers consider certain information to be proprietary, and thus CAS numbers and other limited information may not be available for release.

In no event shall TI's liability arising out of such information exceed the total purchase price of the TI part(s) at issue in this document sold by TI to Customer on an annual basis.

**TAPE AND REEL INFORMATION**

**QUADRANT ASSIGNMENTS FOR PIN 1 ORIENTATION IN TAPE**

\*All dimensions are nominal

Device	Package Type	Package Drawing	Pins	SPQ	Reel Diameter (mm)	Reel Width W1 (mm)	A0 (mm)	B0 (mm)	K0 (mm)	P1 (mm)	W (mm)	Pin1 Quadrant
REF1004C-1.2/2K5	SOIC	D	8	2500	330.0	12.4	6.4	5.2	2.1	8.0	12.0	Q1
REF1004C-2.5/2K5	SOIC	D	8	2500	330.0	12.4	6.4	5.2	2.1	8.0	12.0	Q1
REF1004I-1.2/2K5	SOIC	D	8	2500	330.0	12.4	6.4	5.2	2.1	8.0	12.0	Q1
REF1004I-2.5/2K5	SOIC	D	8	2500	330.0	12.4	6.4	5.2	2.1	8.0	12.0	Q1

## TAPE AND REEL BOX DIMENSIONS



\*All dimensions are nominal

Device	Package Type	Package Drawing	Pins	SPQ	Length (mm)	Width (mm)	Height (mm)
REF1004C-1.2/2K5	SOIC	D	8	2500	356.0	356.0	35.0
REF1004C-2.5/2K5	SOIC	D	8	2500	356.0	356.0	35.0
REF1004I-1.2/2K5	SOIC	D	8	2500	356.0	356.0	35.0
REF1004I-2.5/2K5	SOIC	D	8	2500	356.0	356.0	35.0

**TUBE**

\*All dimensions are nominal

Device	Package Name	Package Type	Pins	SPQ	L (mm)	W (mm)	T (μm)	B (mm)
REF1004C-1.2	D	SOIC	8	75	506.6	8	3940	4.32
REF1004C-2.5	D	SOIC	8	75	506.6	8	3940	4.32
REF1004I-1.2	D	SOIC	8	75	506.6	8	3940	4.32
REF1004I-1.2E4	D	SOIC	8	75	506.6	8	3940	4.32
REF1004I-2.5	D	SOIC	8	75	506.6	8	3940	4.32

## IMPORTANT NOTICE AND DISCLAIMER

TI PROVIDES TECHNICAL AND RELIABILITY DATA (INCLUDING DATA SHEETS), DESIGN RESOURCES (INCLUDING REFERENCE DESIGNS), APPLICATION OR OTHER DESIGN ADVICE, WEB TOOLS, SAFETY INFORMATION, AND OTHER RESOURCES "AS IS" AND WITH ALL FAULTS, AND DISCLAIMS ALL WARRANTIES, EXPRESS AND IMPLIED, INCLUDING WITHOUT LIMITATION ANY IMPLIED WARRANTIES OF MERCHANTABILITY, FITNESS FOR A PARTICULAR PURPOSE OR NON-INFRINGEMENT OF THIRD PARTY INTELLECTUAL PROPERTY RIGHTS.

These resources are intended for skilled developers designing with TI products. You are solely responsible for (1) selecting the appropriate TI products for your application, (2) designing, validating and testing your application, and (3) ensuring your application meets applicable standards, and any other safety, security, regulatory or other requirements.

These resources are subject to change without notice. TI grants you permission to use these resources only for development of an application that uses the TI products described in the resource. Other reproduction and display of these resources is prohibited. No license is granted to any other TI intellectual property right or to any third party intellectual property right. TI disclaims responsibility for, and you will fully indemnify TI and its representatives against, any claims, damages, costs, losses, and liabilities arising out of your use of these resources.

TI's products are provided subject to [TI's Terms of Sale](#) or other applicable terms available either on [ti.com](#) or provided in conjunction with such TI products. TI's provision of these resources does not expand or otherwise alter TI's applicable warranties or warranty disclaimers for TI products.

TI objects to and rejects any additional or different terms you may have proposed.

Mailing Address: Texas Instruments, Post Office Box 655303, Dallas, Texas 75265  
Copyright © 2022, Texas Instruments Incorporated