

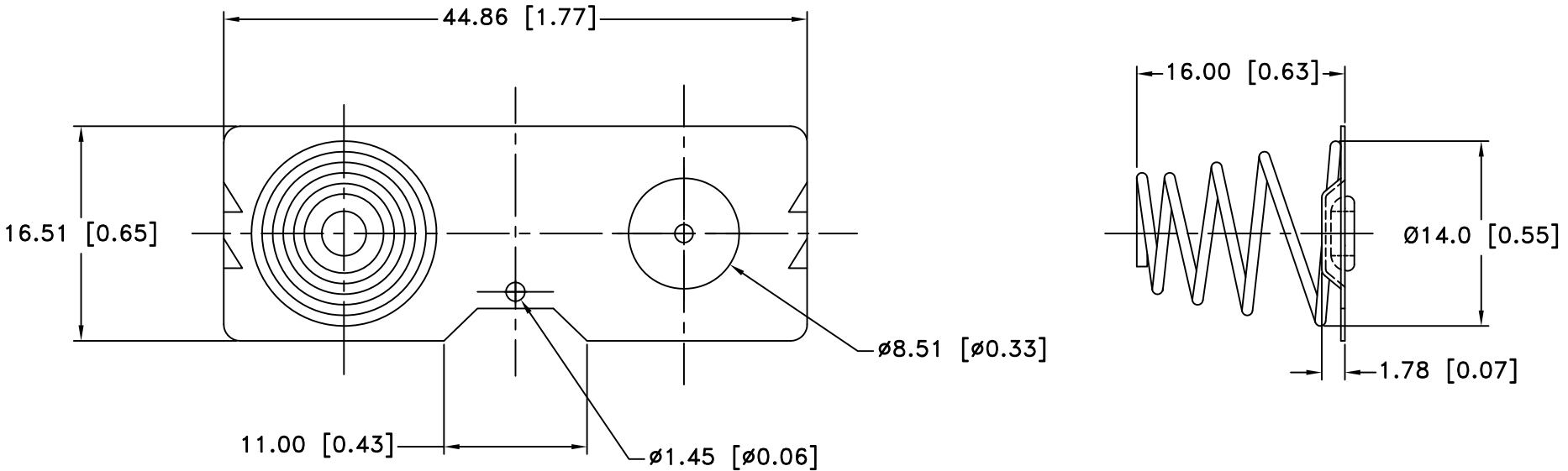

Date	SYM	REVISION RECORD	AUTH	DR.	CK.
03/15/03	A	TIN PLATED WAS NICKEL PLATED	T.B.	B.S.	
2/25/06	B	ADDED "ROHS COMPLIANT"	T.B.	B.S.	
11/21/14	C	UPDATED TO ROHS 2 COMPLIANT	T.B.	B.S.	
03/24/17	D	UPDATED NOTE	T.B.	B.S.	



NOTES:

1. BASE: STEEL, 0.3mm (0.012") THICK. BRIGHT TIN PLATED.
2. SPRING: STEEL, 0.8mm (0.032") THICK. NICKEL PLATED.
3. ROHS 2 COMPLIANT

Tolerance (Except as noted)	 Memory Protection Devices, Inc 200 Broad Hollow Road, Farmingdale, New York 11735	Scale	Drawn By B.S.
			Approved By T.B.
decimal ±.5 (.020)	Title SNT8 "C" CELL BATTERY CONTACT		
Fractional ± .8 (.030)		Date 03/24/17	Drawing Number SN-T8-3
Angular ± 3°			