



A Product Line of
Diodes Incorporated



SPECIFICATION FOR APPROVAL

CUSTOMER _____

NOMINAL FREQUENCY 40.000000 MHz

PRODUCT TYPE TYPE FL 3.2x2.5 SEAM SEALED CRYSTAL

SPEC. NO. (P/N) FL4000065

CUSTOMER P/N _____

ISSUE DATE March 1, 2018

VERSION E

APPROVED	PREPARED	QA
<i>Brenda</i>	<i>Kelly</i>	<i>Song Yang</i>

Diodes Incorporated

No.2, Ziqiang 5th Rd., Zhongli Industrial Park,
Zhongli Dist., Taoyuan City 32063, Taiwan (R.O.C.)
TEL: 886-3-451-8888
FAX: 886-3-461-3865
<https://www.diodes.com>

- *Pb-free
- *RoHS Compliant
- *HF-Halogen Free
- *REACH Compliant

TYPE FL 3.2x2.5 SEAM SEALED CRYSTAL

FL4000065

VER. E 1-Mar-18

ELECTRICAL SPECIFICATIONS

Item	Symbol	Specifications	Units	Notes
Nominal Frequency	Fn	40.000000	MHz	
Mode of Oscillation	MO	AT Cut-Fundamental		
Calibration Load Capacitance	CL	10	pF	
Calibration Tolerance	FL	±10	ppm	at 25°C±3°C
Operating Temperature Range	TR	-20 to +85	°C	
Frequency Stability (Frequency Deviation over the Operating Temperature Range)	F/T	±10	ppm	Reference to the Frequency at 25°C
Operating Drive Level		150	μW	
Maximum Drive Level		300	μW	
Equivalent Series Resistance	ESR	25	Ω	Max
Shunt Capacitance	C0	1.31	pF	Typ
Motional Capacitance	C1	4.21	fF	Typ
Aging at 25°C		±3	ppm	Max, 1st year
Storage Temperature		-55 to +125	°C	
Insulation Resistance		500	MΩ	Min

※ This product doesn't include harmful substance that stipulated by SONY SS-00259 Level 1 and S-AT2-001 Level 1 standard. RoHS Compliant (Pb - Free).

TYPE FL 3.2x2.5 SEAM SEALED CRYSTAL

FL4000065

VER. E 1-Mar-18

RELIABILITY SPECIFICATIONS

MECHANICAL AND ENVIRONMENTAL RATINGS:

- a) FINE LEAK TEST: JESD22-A109 (Condition 1A)
- b) GROSS LEAK TEST: JESD22-A109 (Condition C)
- c) MOISTURE RESISTANCE: JESD22-A113
- d) SHOCK: JESD22-B104 (Condition B)
- e) SOLDERABILITY : (RoHS version): J-STD-002
- f) VIBRATION: JESD22-B103
- g) SOLVENT RESISTANCE: JESD22-B107
- h) RESISTANCE TO SOLDERING HEAT (RoHS version): J-STD-020D Table 5.2 Pb free devices (3 cycles max)

SUGGESTED IR REFLOW PROFILE

*As per IPC-JEDEC J-STD-020D

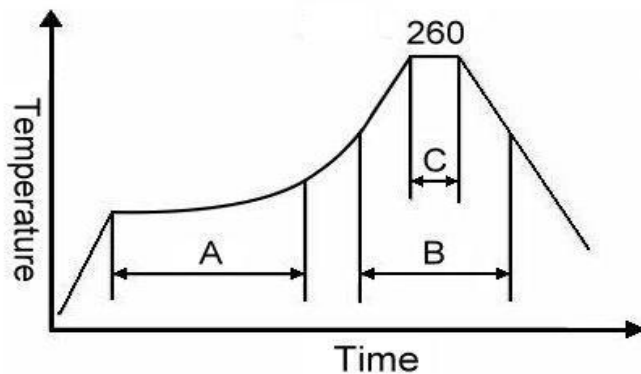

Note:

	Stage	Temperature	Time
A	Preheat	150~200°C	60~120 Sec
B	Primary Heat	217°C	60~150 Sec
C	Peak	260°C	10 Sec

TYPE FL 3.2x2.5 SEAM SEALED CRYSTAL

FL4000065

VER. E 1-Mar-18

MARKING

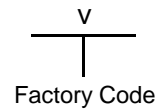
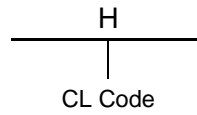
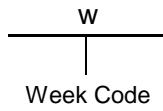
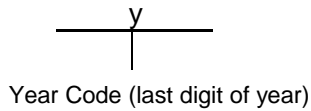
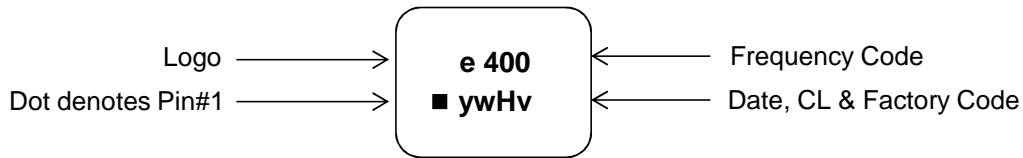

MECHANICAL DRAWINGS (Scale: None. Dimensions are in mm.)

Recommended Land Pattern

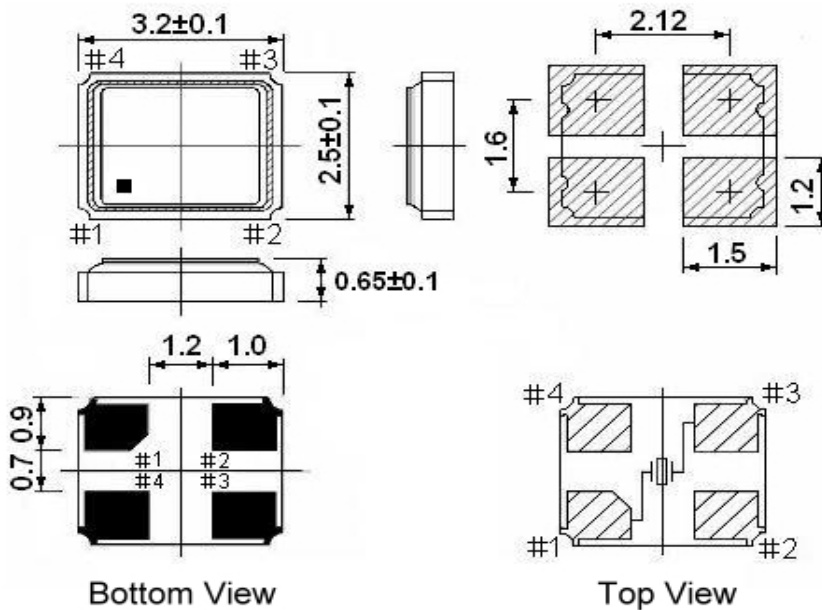

**** Recommended - Pin 1 & 3 : CRYSTAL
 Pin 2 & 4 : GND**

Notes:

1. Package drawings are for reference only, and the appearances of objects may vary.
 Actual packages are based on the real product.
2. The marking dot denotes Pin#1.
3. The position and shape of the chamfer pin may vary and are based on the real product.

TYPE FL 3.2x2.5 SEAM SEALED CRYSTAL

FL4000065

VER. E 1-Mar-18

PACKING

