

11 μ V_{RMS} Low-Noise, 500mA LDO Linear Regulators with Low-Power Mode

MAX38911/MAX38912

General Description

The MAX38911/MAX38912 are low-noise, high-PSRR PMOS linear regulators that deliver up to 500mA load current with only 11 μ V_{RMS} of output noise from 10Hz to 100kHz.

The regulators are fully protected from damage by internal circuitry that provides programmable inrush current limiting, output overcurrent limiting, reverse current limiting, and thermal overload protection.

The MAX38911 is available in WLP and TDFN packages and are default factory preprogrammed to an output voltage of 1.8V. Custom fixed-output voltage levels in the range of 0.8V to 5.0V in 50mV steps are also available, see [Ordering Information](#).

MAX38912 provides enhanced flexibility with adjustable output voltage in the range of 0.8V to 5.0V by using two external feedback resistors.

The MAX38911ANT is packaged in a 1.42mm x 0.83mm, 3 x 2, 6-bump, 0.4mm pitch WLP, while the MAX38911ATA and MAX38912ATA are packaged in a 8-pin, 2mm x 2mm TDFN.

Applications

- Mobile Phones
- Digital Camera and Audio Devices
- Portable and Battery-Powered Equipment
- High-Performance Sensors for Portable Applications
- IOT Sensors
- Imaging and High-Frequency Sensors

Benefits and Features

- Delivers Wide, Flexible Operating Range
 - 1.7V to 5.5V Input Supply Range
 - 0.8V to 5.0V Output Voltage Range
 - 500mA Maximum Output Current
 - 24.3mV Dropout at 500mA Load and 5.0V Input Voltage
 - 19.2 μ A No-Load Supply Current in Low-Power Mode
 - 332 μ A Supply Current in Normal Mode
 - <1 μ A Shutdown Supply Current
- Reduces Noise and Improves Accuracy
 - 11 μ V_{RMS} Output Noise, 10Hz to 100kHz
 - 70dB PSRR at 10kHz, 250mA Load Current, and 300mV Input and Output Voltage Separation
 - \pm 1% DC Accuracy over Load, Line, and Temperature Variations
- Enables Ease-of-Use and Robust Protection
 - Stable with 2 μ F (Minimum Effective) Output Capacitance
 - Programmable Soft-Start Rate
 - Overcurrent and Overtemperature Protection
 - Reverse-Current Protection
 - Power-OK Output
- Reduces Size and Improves Reliability
 - 1.42mm x 0.83mm, 3 x 2, 6-Bump, 0.4mm Pitch WLP
 - 2mm x 2mm, 8-Pin TDFN Package
 - -40°C to +125°C Operating Temperature

[Ordering Information](#) appears at end of data sheet

Application Diagram

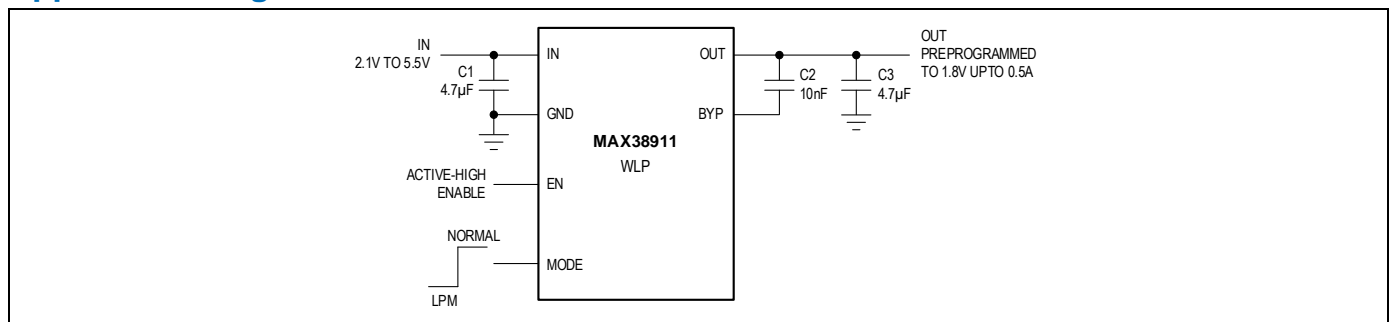

Absolute Maximum Ratings

IN, OUT, EN, FB, OUTS to GND	-0.3V to 6V	Operating Junction Temperature Range	-40°C to +125°C
MODE, BYP, POK to GND	-0.3V to 6V	Maximum Junction Temperature	+150°C
Output Short-Circuit Duration	Continuous	Storage Temperature Range	-65°C to +150°C
Continuous Power Dissipation (T _A = +70°C)		Lead Temperature (Soldering, 10s)	+300°C
WLP (derate 10.51mW/°C above +70°C)	840mW	Soldering Temperature (Reflow)	+260°C
TDFN (derate 11.7mW/°C above +70°C)	937.9mW		

Stresses beyond those listed under "Absolute Maximum Ratings" may cause permanent damage to the device. These are stress ratings only, and functional operation of the device at these or any other conditions beyond those indicated in the operational sections of the specifications is not implied. Exposure to absolute maximum rating conditions for extended periods may affect device reliability.

Package Information

WLP

Package Code	N60P1+1
Outline Number	21-100458
Land Pattern Number	Refer to Application Note 1891
Thermal Resistance, Four-Layer Board	
Junction to Ambient (θ_{JA})	95.15°C/W
Junction to Case (θ_{JC})	N/A

TDFN

Package Code	T822+3C
Outline Number	21-0168
Land Pattern Number	90-0065
Thermal Resistance, Four-Layer Board	
Junction to Ambient (θ_{JA})	85.3°C/W
Junction to Case (θ_{JC})	8.9°C/W

For the latest package outline information and land patterns (footprints), go to www.maximintegrated.com/packages. Note that a "+", "#", or "-" in the package code indicates RoHS status only. Package drawings may show a different suffix character, but the drawing pertains to the package regardless of RoHS status.

Package thermal resistances were obtained using the method described in JEDEC specification JESD51-7, using a four-layer board. For detailed information on package thermal considerations, refer to www.maximintegrated.com/thermal-tutorial.

Electrical Characteristics

(V_{IN} = 3.6V, V_{OUT} = 1.8V, T_J = -40°C to +125°C, C_{BYP} = 10nF, C_{IN} = 4.7 μ F, C_{OUT} = 4.7 μ F, MODE = HIGH, unless mentioned otherwise, Typical values are at T_J = +25°C, unless otherwise specified, see Note 1)

PARAMETER	SYMBOL	CONDITIONS	MIN	TYP	MAX	UNITS
Input Voltage Range	V _{IN}	Guaranteed by output accuracy V _{OUT} < V _{IN} - V _{DO}	1.7		5.5	V
Input Undervoltage Lockout	V _{UVLO}	V _{IN} rising, 100mV hysteresis	1.5	1.6	1.7	V
Output Voltage Range (MAX38911)	V _{OUT}	Output voltage preprogrammed	0.8		5.0	V

($V_{IN} = 3.6V$, $V_{OUT} = 1.8V$, $T_J = -40^\circ C$ to $+125^\circ C$, $C_{BYP} = 10nF$, $C_{IN} = 4.7\mu F$, $C_{OUT} = 4.7\mu F$, $MODE = HIGH$, unless mentioned otherwise, Typical values are at $T_J = +25^\circ C$, unless otherwise specified, see Note 1)

PARAMETER	SYMBOL	CONDITIONS		MIN	TYP	MAX	UNITS
Output Voltage Range (MAX38912)	V_{OUT}	Guaranteed by output accuracy, programmed using external resistor-divider		0.8		5.0	V
Output Accuracy (MAX38911 only)	ACC	MODE = HIGH, I_{OUT} from 0.1mA to 500mA, V_{IN} from $V_{OUT} + 0.3V$ to 5.5V, $V_{IN} > 1.7V$		-1		+1	%
		MODE = LOW, I_{OUT} from 0.1mA to 20mA, V_{IN} from $V_{OUT} + 0.3V$ to 5.5V, $V_{IN} > 1.7V$		-1		+1	
Feedback (FB) Accuracy (MAX38912 only)	V_{FB}	MODE = HIGH, I_{OUT} from 0.1mA to 500mA, V_{IN} from $V_{OUT} + 0.3V$ to 5.5V, $V_{IN} > 1.7V$		0.594	0.6	0.606	V
		MODE = LOW, I_{OUT} from 0.1mA to 20mA, V_{IN} from $V_{OUT} + 0.3V$ to 5.5V, $V_{IN} > 1.7V$		0.594	0.6	0.606	
Output Capacitance	C_{OUT}	Effective capacitance required for stability and proper operation		2	4.7		μF
Input Supply Current	I_{SD}	$V_{EN} = 0V$	$T_J = +25^\circ C$		0.01	1	μA
			$T_J = +125^\circ C$		1.6		
	I_Q	EN = HIGH, MODE = HIGH, $I_{OUT} = 0mA$			332	750	
EN = HIGH, MODE = LOW, $I_{OUT} = 0mA$			19.2	50			
Line Regulation	ACC _{LINE_REG}	V_{IN} from 3.6V to 5.5V, $I_{OUT} = 500mA$, $V_{OUT} = 3.3V$			0.068		%/V
Load Regulation	ACC _{LOAD_REG}	I_{OUT} from 0.1mA to 500mA, $V_{IN} = V_{OUT} + 0.3V$			0.078		%
Load Transient		$I_{OUT} = 50mA$ to 500mA or 500mA to 50mA, $t_{RISE} = t_{FALL} = 1\mu s$			48		mV
Line Transient		$V_{IN} = 2.1V$ to 2.5V to 2.1V, $I_{OUT} = 500mA$, $t_{RISE} = t_{FALL} = 5\mu s$			5		mV
Output Transient at MODE Transition		MODE rising or falling, $I_{OUT} = 1mA$			20.5		mV
MODE Transition Time		MODE from LOW to HIGH to $I_{OUT} = 500mA$			50		μs
Power-Supply Rejection Ratio	PSRR	$V_{IN} = 2.1V$, $V_{OUT} = 1.8V$, $I_{OUT} = 100mA$	$f = 1kHz$		80		dB
			$f = 10kHz$		76		
			$f = 100kHz$		60		
			$f = 1MHz$		46		
		$V_{IN} = 3.6V$, $V_{OUT} = 3.3V$, $I_{OUT} = 100mA$	$f = 1kHz$		80		
			$f = 10kHz$		78		
			$f = 100kHz$		60		
			$f = 1MHz$		44		
Output Noise		$V_{IN} = 2.1V$, $I_{OUT} = 100mA$, 10Hz to 100kHz	$C_{BYP} = 47nF$		11.1		μV_{RMS}
Dropout Voltage (MAX38911 WLP) (Note 2)	V_{DO}	$I_{OUT} = 500mA$, when MODE = HIGH	$V_{IN} = 5.0V$		24.3		mV
			$V_{IN} = 3.6V$		36	100	
			$V_{IN} = 2.0V$		58	120	

($V_{IN} = 3.6V$, $V_{OUT} = 1.8V$, $T_J = -40^\circ C$ to $+125^\circ C$, $C_{BYP} = 10nF$, $C_{IN} = 4.7\mu F$, $C_{OUT} = 4.7\mu F$, $MODE = HIGH$, unless mentioned otherwise, Typical values are at $T_J = +25^\circ C$, unless otherwise specified, see Note 1)

PARAMETER	SYMBOL	CONDITIONS		MIN	TYP	MAX	UNITS
			$V_{IN} = 1.7V$		83	165	
Dropout Voltage (MAX38911 TDFN, MAX38912) (Note 2)	V_{DO}	$I_{OUT} = 500mA$, when $MODE = HIGH$	$V_{IN} = 3.6V$		50	100	mV
			$V_{IN} = 2.0V$		70	200	
			$V_{IN} = 1.7V$		100	300	
Dropout Voltage (MAX38911, MAX38912) (Note 2)	V_{DO}	$I_{OUT} = 20mA$, when $MODE = LOW$	$V_{IN} = 3.6V$		25	50	mV
			$V_{IN} = 2.0V$		48	100	
			$V_{IN} = 1.7V$		75	150	
Maximum Current Limit	I_{LIM}	MODE = HIGH, $V_{OUTS}/OUT = 0.9 \times V_{NOMINAL}$, $V_{OUT_NOMINAL} = 1.8V$, $V_{IN} - V_{OUT} = 500mV$		600	700	800	mA
		MODE = LOW, $V_{OUTS}/OUT = 0.9 \times V_{NOMINAL}$, $V_{OUT_NOMINAL} = 1.8V$		22			
BYP Capacitor Range	C_{BYP}			0.001		0.1	μF
BYP Soft-Start Current		From BYP to GND during startup			50		μA
EN/MODE Input Threshold	V_{IH}	V_{IN} from 1.7V to 5.5V	V_{EN} and V_{MODE} rising		0.8	1.2	V
	V_{IL}	V_{IN} from 1.7V to 5.5V	V_{EN} and V_{MODE} falling	0.4	0.7		
EN/MODE Input Leakage Current	I_{EN_LK} , I_{MODE_LK}	V_{EN} and V_{MODE} from 0 to 5.5V	$T_J = +25^\circ C$	-1	0.001	1	μA
			$T_J = +125^\circ C$		0.01		
POK Threshold (MAX38911 TDFN, MAX38912)		V_{OUT} when POK switches	V_{OUT} rising	88	91	94	%
			V_{OUT} falling		88		
POK Voltage Low (MAX38911 TDFN, MAX38912)	V_{OL}	$I_{POK} = 1mA$			10	100	mV
POK Leakage Current (MAX38911 TDFN, MAX38912)	I_{POK_LK}	$V_{POK} = 5.5V$	$T_J = +25^\circ C$	-0.1	0.001	0.1	μA
			$T_J = +125^\circ C$		0.01		
IN Reverse Current Threshold		$V_{OUT} = 3.6V$, when V_{IN} falls to 0V	MODE = HIGH		200		mA
			MODE = LOW		10		
Thermal Shutdown Threshold		T_J when output turns on/off	T_J rising		165		$^\circ C$
			T_J falling		150		

Note 1: Limits over the specified operating temperature and supply voltage range are guaranteed by design and characterization, and production tested at room temperature only.

Note 2: Dropout voltage is defined as ($V_{IN} - V_{OUT}$) when V_{OUT} is 95% of its nominal value.

Typical Operating Characteristics

(MAX38911, $V_{IN} = 2.1V$, $V_{OUT} = 1.8V$, $T_A = +25^\circ C$, $C_{IN} = 4.7\mu F$, $C_{OUT} = 4.7\mu F$, $C_{BYP} = 10nF$, unless otherwise noted.)

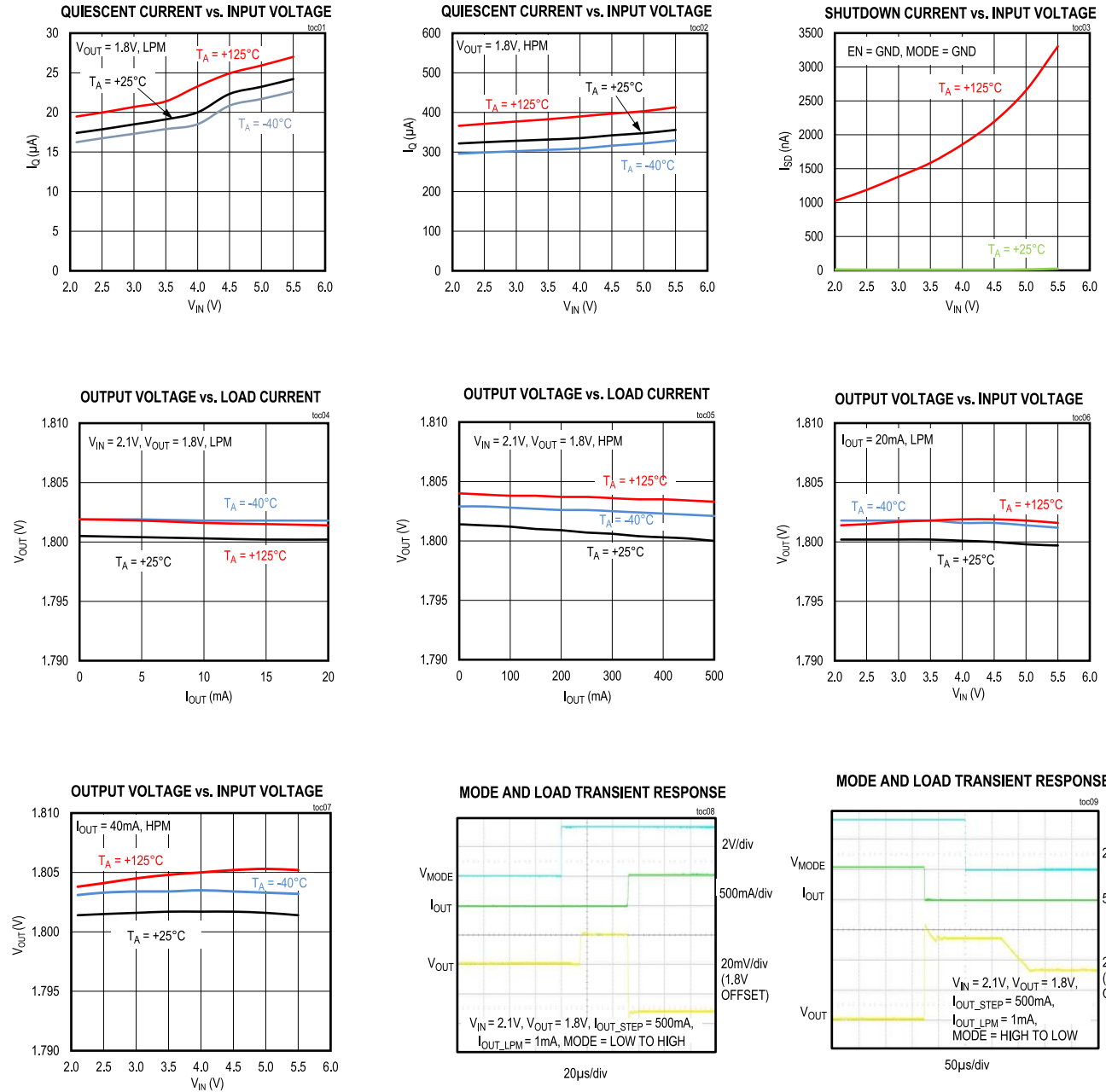

(MAX38911, $V_{IN} = 2.1V$, $V_{OUT} = 1.8V$, $T_A = +25^\circ C$, $C_{IN} = 4.7\mu F$, $C_{OUT} = 4.7\mu F$, $C_{BYP} = 10nF$, unless otherwise noted.)

LINE TRANSIENT RESPONSE

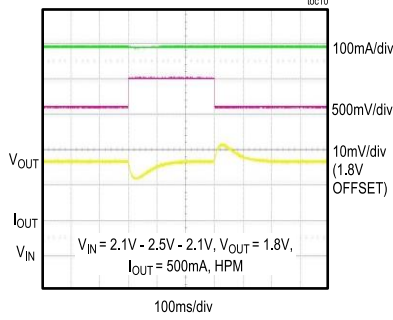

SOFT-START RESPONSE

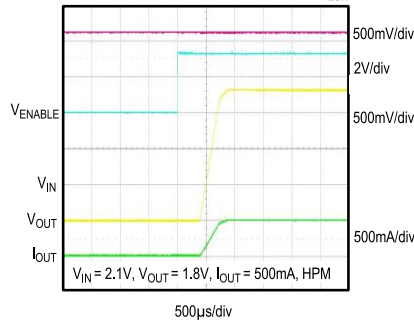

DROPOUT VOLTAGE vs. OUTPUT CURRENT

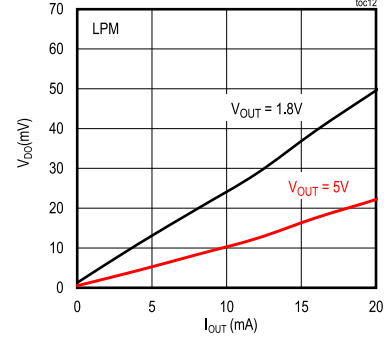

DROPOUT VOLTAGE vs. OUTPUT CURRENT

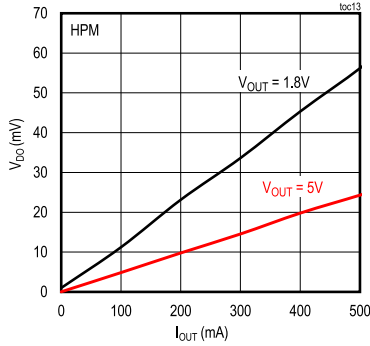

INPUT SUPPLY PSRR vs. FREQUENCY

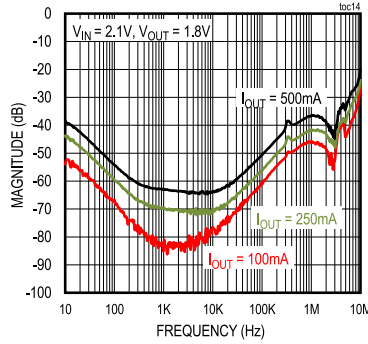

INPUT SUPPLY PSRR vs. FREQUENCY

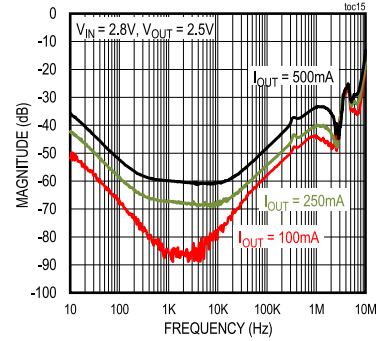

INPUT SUPPLY PSRR vs. FREQUENCY

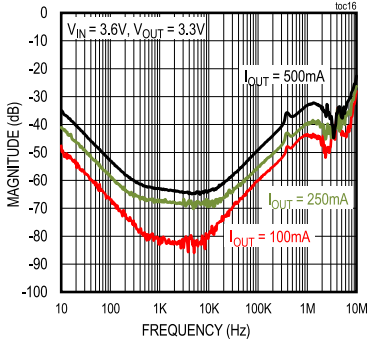

INPUT SUPPLY PSRR vs. FREQUENCY

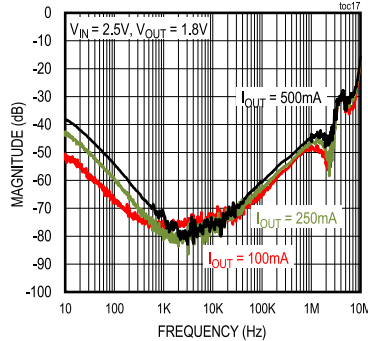

INPUT SUPPLY PSRR vs. FREQUENCY

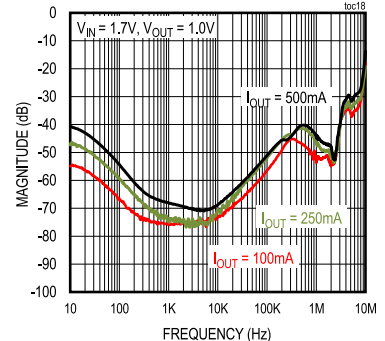

(MAX38911, $V_{IN} = 2.1V$, $V_{OUT} = 1.8V$, $T_A = +25^\circ C$, $C_{IN} = 4.7\mu F$, $C_{OUT} = 4.7\mu F$, $C_{BYP} = 10nF$, unless otherwise noted.)

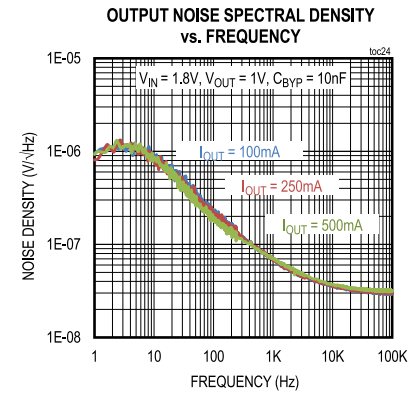
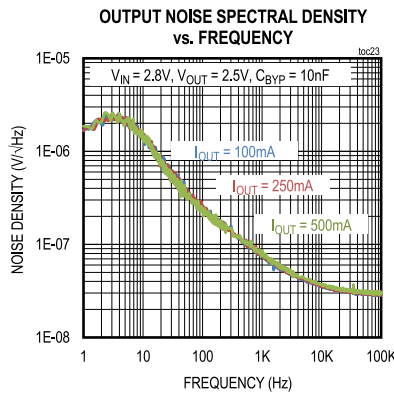
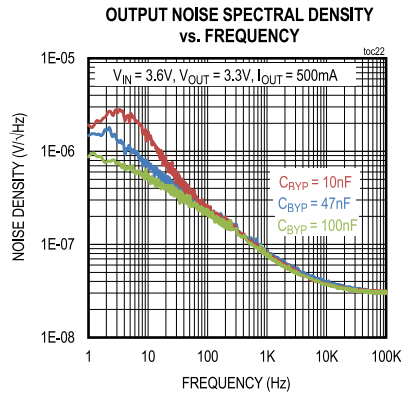
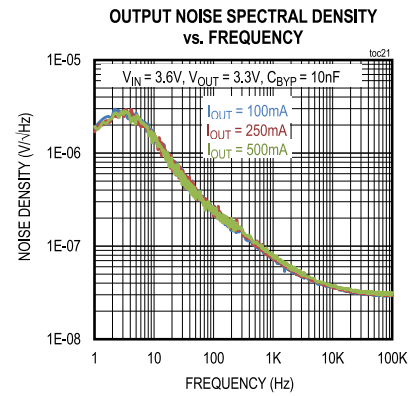
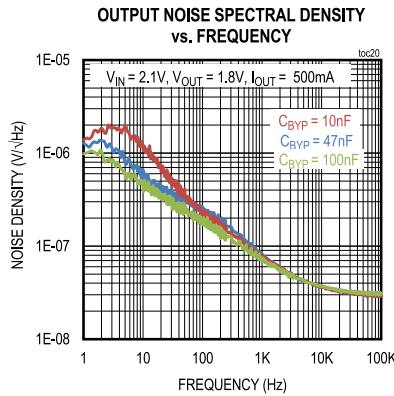
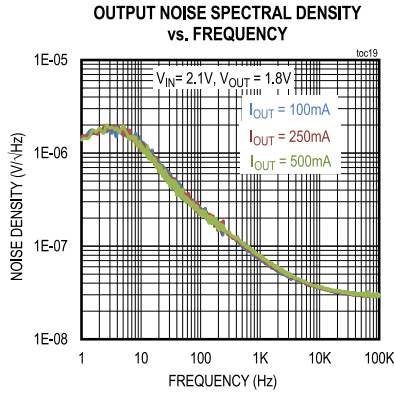

Pin Configurations

6 WLP

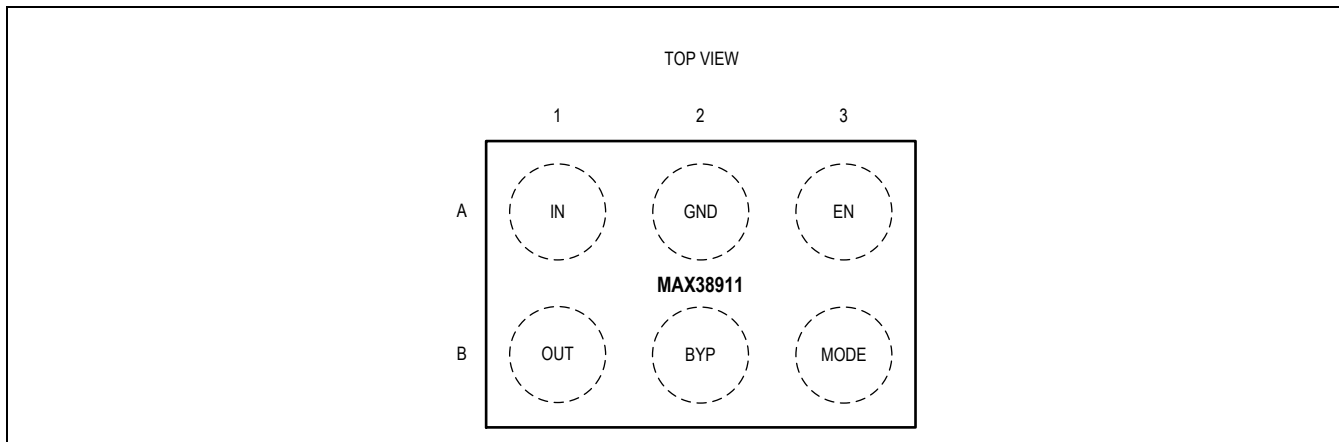

8 TDFN

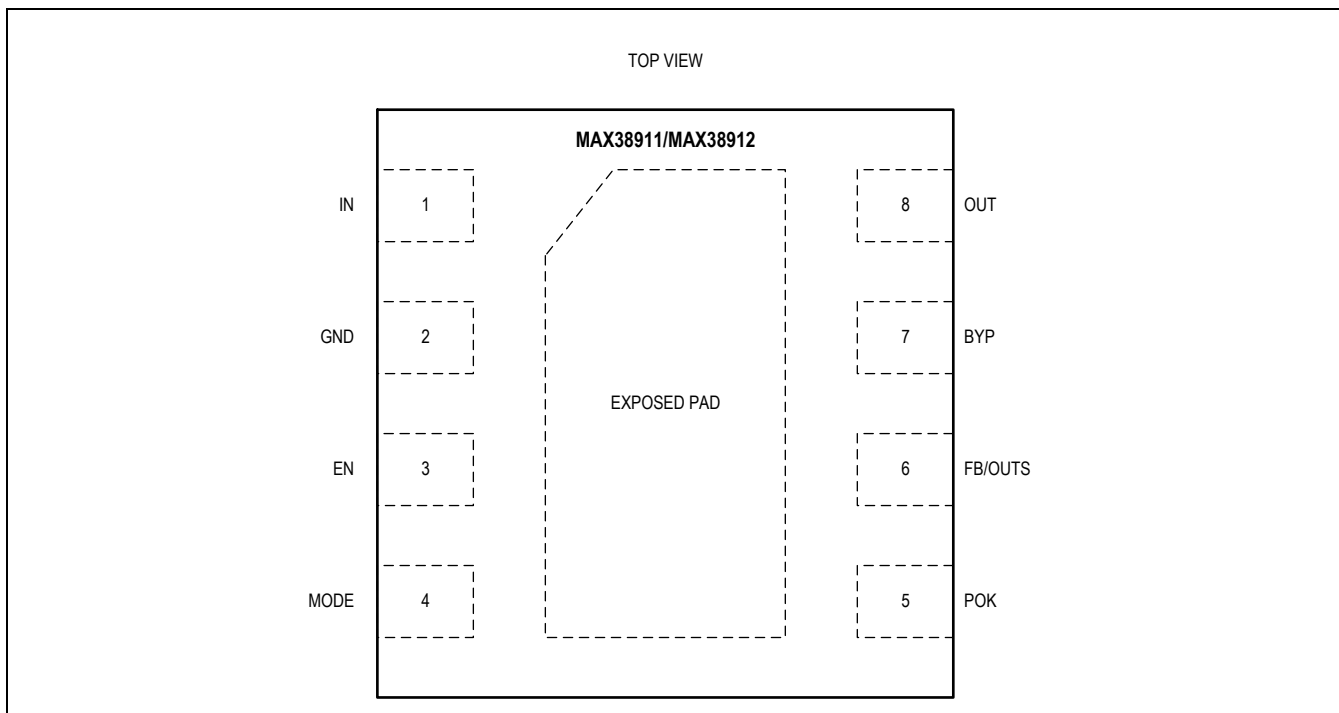

Pin Descriptions

PIN		NAME	FUNCTION
WLP	TDFN		
A1	1	IN	Regulator Supply Input Pin. Connect to voltage between 1.7V and 5.5V, and bypass with a 4.7 μ F capacitor from IN to GND.
A2	2	GND	Regulator Ground Pin. Bring IN and OUT bypass capacitor GND connections to this pin for best performance. Short the pin to EP in PCB layout in TDFN applications.
A3	3	EN	Enable Input Pin. Connect this pin to a logic signal to enable (V_{EN} high) or disable (V_{EN} low) the regulator output. Connect to IN to keep the output enabled whenever a valid supply voltage is present.
B3	4	MODE	Mode-Select Pin. Connect this pin to a logic-high signal if normal operation is desired, and connect it to a logic-low signal if low-power operation is desired. When MODE is high, maximum output load current when LDO is in regulation is 500mA, and when MODE is low, maximum output load current is 20mA.
—	5	POK	Power-OK Output Pin. Connect a pullup resistor from this pin to a supply to create a signal that goes high after the regulator output has reached its regulation voltage.
—	6	FB/OUTS	MAX38911: Output Voltage Sense Input. Connect to the load at a point where accurate regulation is required to eliminate voltage drops. MAX38912: Feedback Input Pin. Connect a resistor-divider string from OUT to GND with the midpoint tied to this pin to set the output voltage. In a typical application circuit, $V_{OUT} = 0.6V \times (1 + R_{FBTOP}/R_{FBBOT})$.
B2	7	BYP	Bypass Capacitor Input Pin. Connect a 0.001 μ F to 0.1 μ F capacitor between OUT and BYP to reduce output noise and set the regulator soft-start rate.
B1	8	OUT	Regulator Output Pin. Sources up to 500mA when MODE = HIGH and up to 20mA when MODE = LOW at the output regulation voltage. Bypass with a 4.7 μ F (2 μ F minimum effective capacitance), low-ESR (< 0.03 Ω) capacitor to GND.
—	EP	EP	Exposed Pad. Connect the exposed pad to a ground plane with low thermal resistance to provide best heat sinking. Connected to GND internally.

Typical Application Circuits

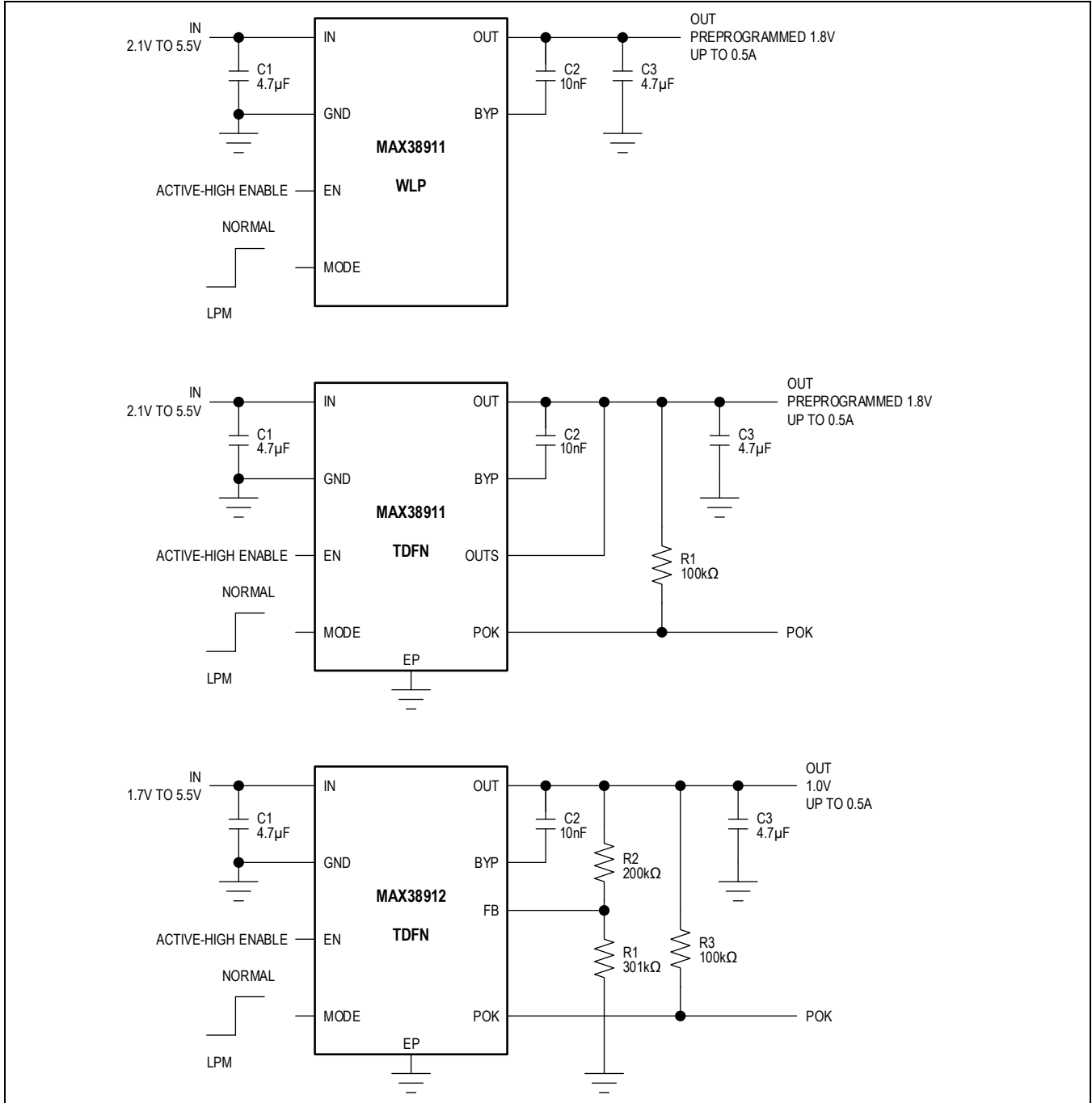

Simplified Block Diagram

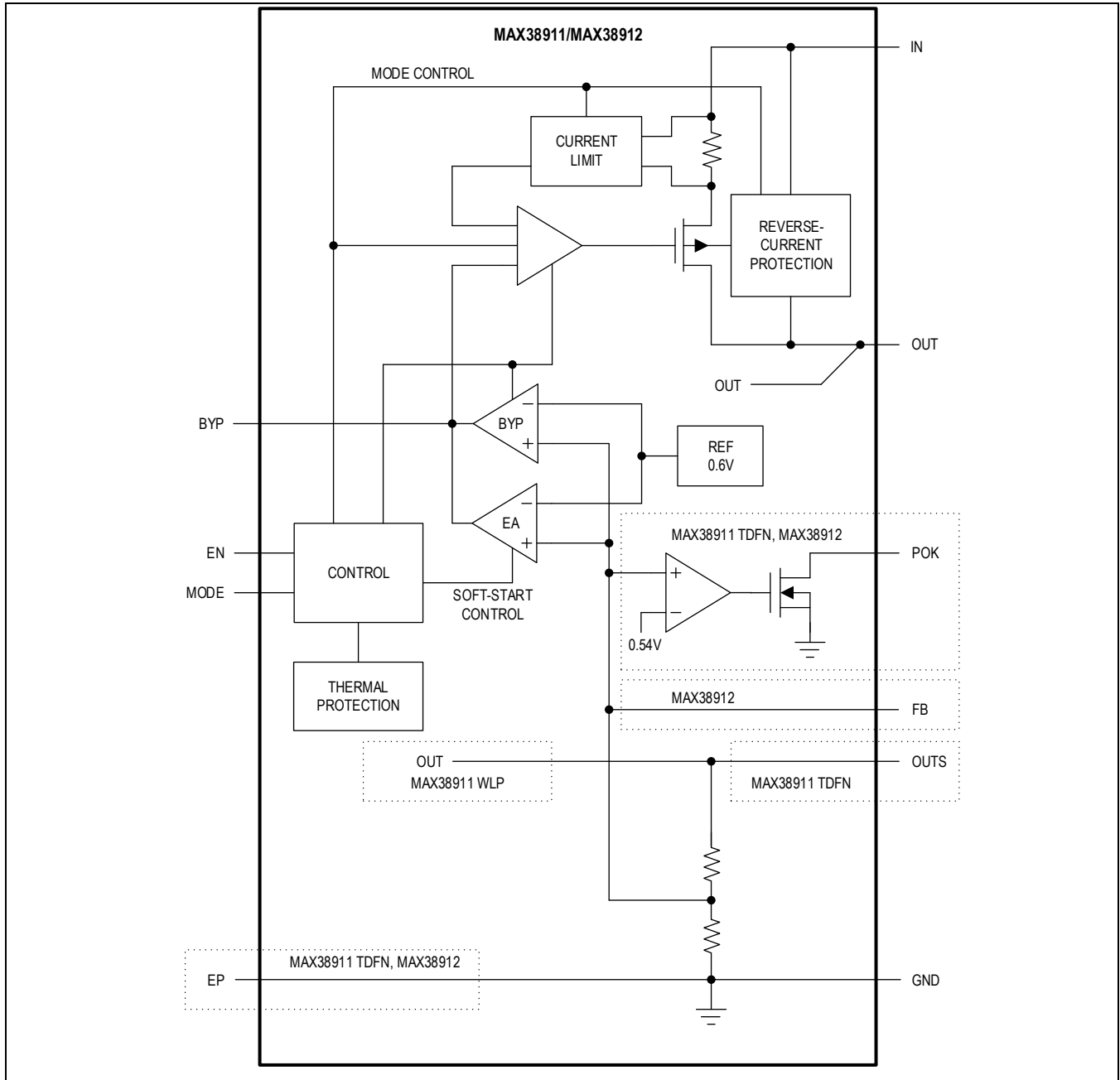

Detailed Description

The MAX38911/MAX38912 are low noise, high-PSRR PMOS linear regulators that deliver up to 500mA load current with only 11 μ V_{RMS} of output noise from 10Hz to 100kHz. These regulators maintain $\pm 1\%$ output accuracy over line, load, and temperature variations. These devices feature a low-power mode of operation where they maintain excellent regulation accuracy, consuming very low quiescent current from the supply. In low-power mode, the devices can deliver up to 20mA load current and have a no-load quiescent current of 19.2 μ A.

These regulators support a wide input supply range from 1.7V up to 5.5V. The output voltage can be adjusted to a value in the range of 0.8V to 5.0V.

The MAX38911 is preconfigured to have a single output voltage in the range of 0.8V to 5.0V, while the output voltage on the MAX38912 can be adjusted to a value in the range of 0.8V to 5.0V by using two external feedback resistors.

The regulators are fully protected from damage by internal circuitry that provides programmable inrush current limiting, output over-current limiting, reverse current limiting, and thermal overload protection.

Modes of Operation

The MAX38911/MAX38912 feature low-power and high-power modes of operation. The modes are selected based on the state of the MODE pin. The device will always be in the high-power mode during startup regardless of the state of the MODE pin. Upon completion of the soft-start, the device will read the state of the MODE pin and adjust the mode of operation, if required.

Low-Power Mode of Operation

The MAX38911/MAX38912 enter low-power mode if the MODE pin is pulled low. In this mode, the device consumes 19.2 μ A of current and can source up to 20mA. Excellent regulation accuracy is maintained in the low-power mode.

High-Power Mode of Operation

The MAX38911/MAX38912 enter high-power mode if the MODE pin is pulled high. In this mode, the device consumes 332 μ A of current and can source up to 500mA.

MODE Transition

Transitioning from low-power mode to high-power mode will adjust the internal regulation point, resulting in a transient excursion at the output. The excursion is a function of load current and temperature, the maximum being at maximum load current in low-power mode (20mA) and at an elevated die temperature. In order to minimize output voltage transient excursion at the MODE transition, it is recommended to keep the load current at 1mA level or below. It will take 50 μ s of settling time prior to the host being able to apply the load current that is supported in high-power mode.

When the host is ready to place the device back into the low-power mode, it will reduce the load current to levels supported in low-power mode 80 μ s prior to driving the MODE pin low. Similarly, the MODE pin transition from high to low causes transient excursion at the output. The load current remains constant during the settling period, after which it can be adjusted.

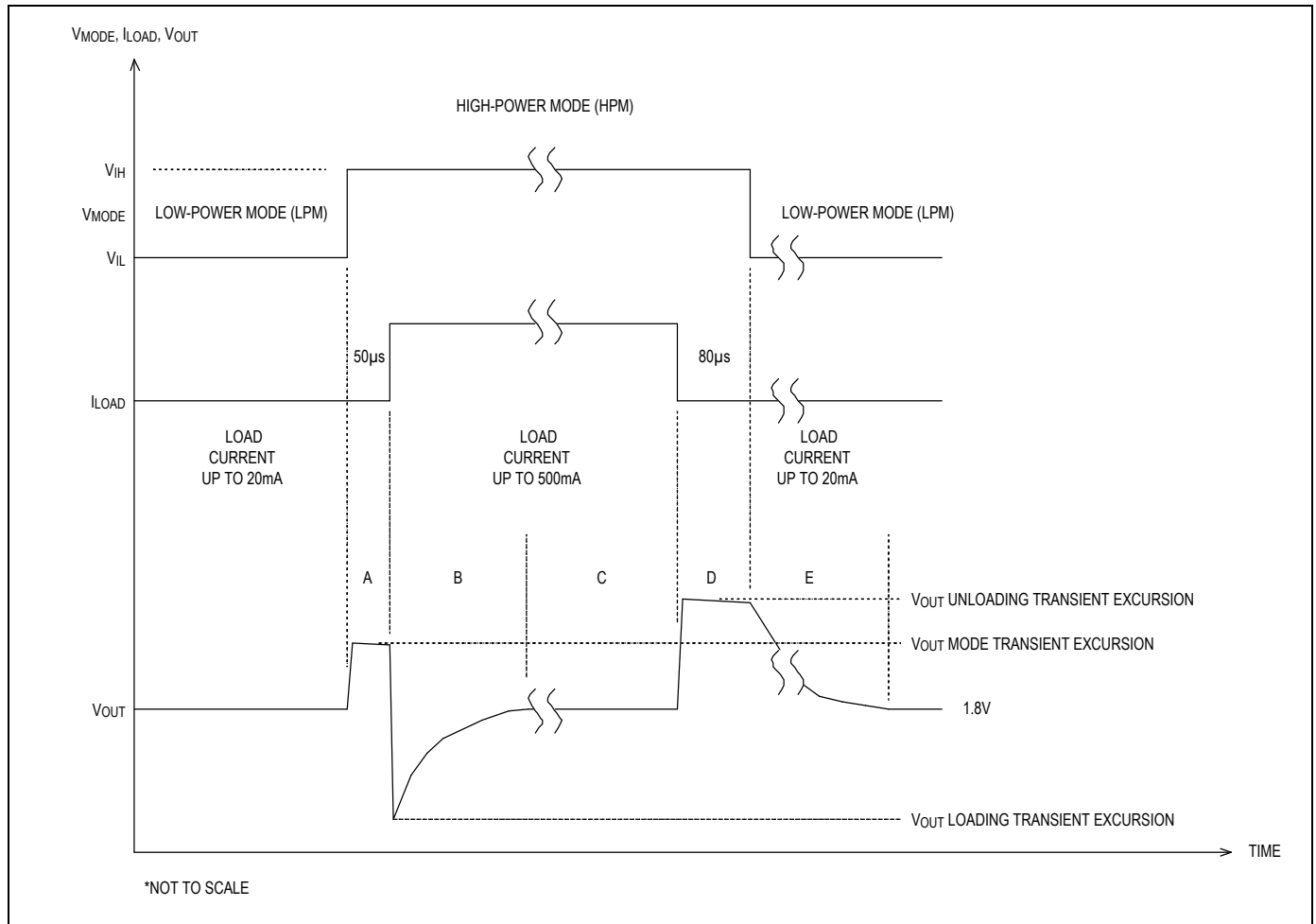

Figure 1. MODE Transition

The MODE transition is illustrated in [Figure 1](#). Different operating regions are:

- A – The MODE transitions from low to high while the load current is kept in the low-power mode range. The output voltage goes up due to the mode transient and then starts to settle. The high-power mode current step can be applied after a 50 μ s time period elapses.
- B – The high-power mode load step is applied after 50 μ s. The output voltage is recovering from the loading transient.
- C – The device has fully recovered from the loading transient.
- D – The host lowers the load current prior to MODE changes to the low-power mode. This creates an unloading transient event, after which the output voltage starts to settle. After 80 μ s of settling time, the host can transition the MODE pin to low.
- E – The output voltage comes back to the target level.

Enable (EN)

The MAX38911/MAX38912 include an enable input (EN). Pull EN low to shut down the output. In shutdown mode, the device consumes 10nA of current from the input supply. Drive EN high to enable the output. If a separate shutdown signal is not available, connect EN to IN.

Bypass (BYP)

The capacitor that is connected from BYP to OUT filters the noise of the reference, feedback resistors, and regulator input stage, and it provides a high-speed feedback path for improved transient response. A 0.01 μ F capacitor rolls off input noise at around 32Hz. The slew rate of the output voltage during startup is also determined by the BYP capacitor. A 0.01 μ F capacitor sets the slew rate to 5V/ms. This startup rate results in a 23.5mA slew current drawn from the input at startup to

charge the 4.7 μ F output capacitance. The BYP capacitor value can be adjusted from 0.001 μ F to 0.1 μ F to change the startup slew rate according to the following formula:

$$\text{Startup Slew Rate} = (5\text{V/ms}) \times (0.01\mu\text{F}/C_{\text{BYP}})$$

where C_{BYP} is measured in μ F.

Selecting a BYP capacitor larger than 10nF is primarily to slow down the soft-start rate and minimize the inrush current since the output noise will remain very constant with improvement of about 1.0 μ V_{RMS}.

Note that this slew rate applies only at startup. The recovery from an overload condition occurs at a slew rate approximately 500 times slower. Also note that being a low-frequency filter node, BYP is sensitive to leakage. BYP leakage currents above 10nA cause measurable inaccuracy at the output and should be avoided.

Power-OK (POK)

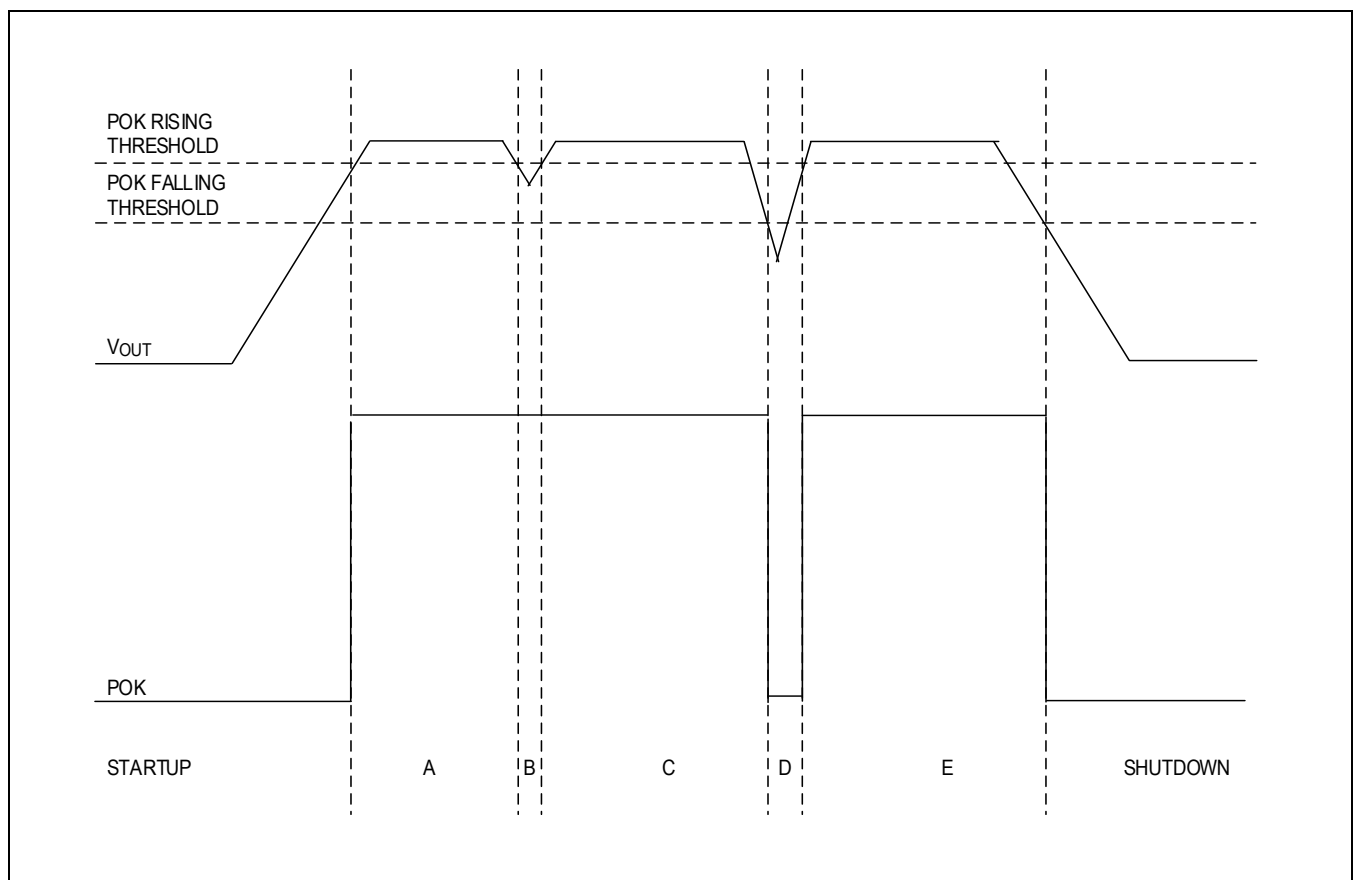

Figure 2. Typical POK Operation

The POK operation versus the output voltage is shown in [Figure 2](#). The different operating regions are:

- A – The device is in regulation.
- B – V_{OUT} sags, but does not reach the POK falling threshold.
- C – The device is in regulation.
- D – V_{OUT} sags low enough to cross the POK falling threshold. The POK is driven low until V_{OUT} recovers above the POK rising threshold.
- E – The device is in regulation.

The Power-OK (POK) function monitors the output voltage to indicate that it is in regulation. The POK pin is open-drain and requires a pullup resistor to an external supply to properly report the device regulation status to other devices so it can be used for sequencing. Check if the external pullup supply voltage results in a valid logic levels for the receiving device or devices. The range of the pullup resistance is between 10k Ω and 200k Ω . Its lower limit comes from a pulldown strength of the POK transistor while the higher limit is determined by maximum leakage current at the POK pin. The signal is low while the device is in shutdown.

The POK is driven low during startup. It gets released and pulled up once the output voltage reaches the POK rising threshold (91% of the regulation target). If the output voltage sags to below the POK falling threshold during regulation, the POK signal is driven low to indicate that the output voltage dropped out of regulation. During shutdown, the POK signal is driven low once the output voltage crosses the POK falling threshold (88% of the regulation target). The POK signal is active during output voltage transition.

Protection

The MAX38911/MAX38912 are fully protected from an overload condition by current-limiting and thermal-overload protection circuits. If the output is shorted to GND, the output current will be limited to 700mA (typ) after the output capacitor discharges through the shorting path. Under these conditions, the device quickly heats up. When the junction temperature reaches +165°C, the thermal-protection circuit shuts the output device off. Once the device cools to +150°C, the regulator enables in order to reestablish regulation. If the fault persists, the output cycles on and off as the junction temperature slews between +150°C and +165°C. Continuously operating in the fault conditions or above a +125°C junction temperature is not recommended since long-term reliability may be reduced. In dropout, the current limit will trigger at 850mA (typ). Once the limit is triggered, the device will limit the current to 700mA.

The MAX38911/MAX38912 provide reverse-current protection when the output voltage is higher than the input. The MAX38911/MAX38912 include a reverse-voltage detector that trips when IN drops below OUT, shutting off the regulator and opening the body diode connection, thus preventing any reverse current. The reverse current is a current that flows through the body diode of the pass element and is undesired due to its impact on power dissipation and long-term reliability, especially at higher current levels. Thermal protection can also be triggered when the device is exposed to excessive heat in the system, causing the die temperature to reach undesired levels.

Undervoltage Lockout (UVLO)

The MAX38911/MAX38912 undervoltage lockout (UVLO) circuit responds quickly to input voltage glitches and will disable the device's output if the rail dips below the UVLO falling threshold. The local input capacitance prevents transient brownout conditions in most applications. The device is ready once the input voltage exceeds the UVLO rising threshold during power-up.

During V_{IN} power-up, the MAX38911/MAX38912 begin V_{OUT} soft-start after V_{IN} crosses the V_{IN} UVLO rising threshold. This assures proper V_{OUT} ramp up and transition to regulation. The V_{OUT} soft-start rate should be kept at or slower than the V_{IN} slew rate to avoid entering the dropout. In some situations, V_{IN} transients can place the regulator into dropout. As V_{IN} starts climbing again and the device comes out of the dropout, the output can overshoot. This condition is avoided by using an enable signal or by increasing the soft-start time with larger C_{BYP} .

Output Voltage Configuration

MAX38911 Output Voltage Configuration

The MAX38911 output voltage comes preprogrammed. The default output voltage setting is 1.8V. For other output voltage settings between 0.8V and 5.0V in 50mV steps, contact a Maxim Integrated representative.

MAX38912 Output Voltage Configuration

The MAX38912 uses external feedback resistors to set the output regulation voltage. The output voltage can be set from 0.8V to 5.0V. Set the bottom feedback resistor R1 to 301k Ω or less to minimize the FB input bias current error. Calculate the value of the top feedback resistor R2 as follows:

$$R2 = R1 \times (V_{OUT}/V_{FB} - 1)$$

where V_{FB} is the feedback regulation voltage of 0.6V.

To set the output to 1.0V, for example, R2 should be:

$$R2 = 301k\Omega \times (1.0V/0.6V - 1) = 200k\Omega$$

A smaller R1 is recommended to optimize for noise performance.

Values of the resistor-divider and its tolerance will have a direct impact on V_{OUT} accuracy. Resistors of 1% or better are recommended. [Table 1](#) shows the recommended values for the feedback resistors.

Table 1. Recommended Feedback Resistor Values

TARGETED OUTPUT VOLTAGE (V)	TOP FEEDBACK RESISTOR VALUES (k Ω)	BOTTOM FEEDBACK RESISTOR VALUES (k Ω)	CALCULATED OUTPUT VOLTAGE (V)
0.8	100	301	0.799
1.0	200	301	0.999
1.2	301	301	1.2
1.5	453	301	1.503
1.8	604	301	1.804
2.5	953	301	2.5
3.0	1210	301	3.012
3.3	1370	301	3.331
5.0	2210	301	5.005

Application Information

Input and Output Capacitors

The MAX38911/MAX38912 are designed to have stable operation using low equivalent series resistance (ESR) ceramic capacitors at the input and output pins. Multilayer ceramic capacitors (MLCC) with X7R dielectric are commonly used for these types of applications and are recommended due to their relatively stable capacitance across temperature. Nevertheless, the amount of effective capacitance depends on the operating DC bias, capacitance tolerance with temperature, choice of dielectric. Therefore, the capacitor data sheet must be properly examined.

The MAX38911/MAX38912 are designed and characterized for operation with X7R ceramic capacitors of 4.7 μ F (2.0 μ F of effective capacitance) at both the input and output. These capacitors shall be placed as close as possible to the respective input and output pins to minimize trace parasitics. There is no maximum output capacitance limitation due to stability. However, for 5V output voltage applications, it is recommended to keep output capacitance to a maximum of 4.7 μ F effective capacitance in order to minimize short-circuit current buildup in an inductive shorting path.

Thermal Consideration

In order to optimize MAX38911/MAX38912 performance, special consideration is given to the device power dissipation and PCB thermal design. Power dissipation in the regulator depends on the input-to-output voltage difference and load conditions. This can be calculated by the following equation:

$$\text{Loss (W)} = (V_{\text{IN}} - V_{\text{OUT}}) \times I_{\text{LOAD}}$$

The optimal power dissipation can be achieved by carefully choosing the input voltage for a given output target voltage.

The main thermal conduction path for the device is through the exposed pad of the package. As a result, the thermal pad must be soldered to a copper pad area under the device. Thermal plated vias must be placed inside the thermal PCB pad to transfer heat to different GND layers in the system. The vias should be capped to minimize solder voids. The maximum power dissipation is determined by using thermal resistance from the device junction to ambient keeping the maximum junction temperature below +125°C. Thermal properties of the package are given in the [Package Information](#) section.

The first-order power dissipation estimate for the 3.3V V_{IN} and 2.5V V_{OUT} with a load current of 300mA is:

$$\text{Loss (W)} = (V_{\text{IN}} - V_{\text{OUT}}) \times I_{\text{LOAD}} = (3.3\text{V} - 2.5\text{V}) \times 0.3\text{A} = 0.24\text{W}$$

Assuming the MAX38911ATA+ is used, this power dissipation will raise the junction temperature to:

$$T_{\text{J}} = (\text{PD} \times \theta_{\text{JA}}) + 25^{\circ}\text{C} = (0.24\text{W} \times 85.3^{\circ}\text{C/W}) + 25^{\circ}\text{C} = 45.47^{\circ}\text{C}$$

Ordering Information

PART	TEMP RANGE	PIN-PACKAGE	FEATURE
MAX38911ANT+	-40°C to +125°C	3 x 2 bump, 0.4mm pitch WLP	MODE pin, default preprogrammed output to 1.8V
MAX38911ANT__*	-40°C to +125°C	3 x 2 bump, 0.4mm pitch WLP	MODE pin, custom preprogrammed output voltage.
MAX38911ATA+	-40°C to +125°C	8-pin, 2mm x 2mm TDFN	MODE pin, default preprogrammed output to 1.8V, OUTS pin for remote sensing, POK output
MAX38911ATA__*	-40°C to +125°C	8-pin, 2mm x 2mm TDFN	MODE pin, custom preprogrammed output voltage, OUTS pin for remote sensing, POK output
MAX38912ATA+	-40°C to +125°C	8-pin, 2mm x 2mm TDFN	MODE pin, FB pin with external feedback divider network, POK output

+ Denotes a lead (Pb)-free/RoHS-compliant package

* Contact factory/Maxim Representative for availability and choice of factory preprogrammed output voltages- 0.8V to 5.0V, 50mV steps

Revision History

REVISION NUMBER	REVISION DATE	DESCRIPTION	PAGES CHANGED
0	1/21	Release for intro	—
1	8/21	Releasing New parts in family MAX38911ATA+, MAX38912ATA+. Updated <i>General Description, Benefits and Features, Electrical Characteristics, Pin Description, Power-OK (POK) Section, and Ordering Information Table.</i>	1, 4, 9, 16, 17

