

# NEO-M8Q-01A

## u-blox M8 concurrent GNSS module - Automotive Grade Data Sheet



### Abstract

Technical data sheet describing the NEO-M8Q-01A module which provides concurrent reception of up to 3 GNSS (GPS, Galileo, GLONASS, BeiDou). It is designed to meet automotive market requirements and supports an extended operating temperature range from  $-40\text{ }^{\circ}\text{C}$  to  $+105\text{ }^{\circ}\text{C}$ .

# Document Information

<b>Title</b>	<b>NEO-M8Q-01A</b>	
<b>Subtitle</b>	u-blox M8 concurrent GNSS module - Automotive Grade	
<b>Document type</b>	Data Sheet	
<b>Document number</b>	UBX-15013820	
<b>Revision and date</b>	R05	27-May-2019
<b>Document status</b>	Production Information	

<b>Product status</b>	<b>Corresponding content status</b>	
<b>In Development / Prototype</b>	Objective Specification	Target values. Revised and supplementary data will be published later.
<b>Engineering Sample</b>	Advance Information	Data based on early testing. Revised and supplementary data will be published later.
<b>Initial Production</b>	Early Production Information	Data from product verification. Revised and supplementary data may be published later.
<b>Mass Production / End of Life</b>	Production Information	Document contains the final product specification.

This document applies to the following products:

<b>Product name</b>	<b>Type number</b>	<b>Firmware version</b>	<b>PCN reference</b>
NEO-M8Q	NEO-M8Q-01A-10	ROM SPG 3.01	N/A

u-blox or third parties may hold intellectual property rights in the products, names, logos and designs included in this document. Copying, reproduction, modification or disclosure to third parties of this document or any part thereof is only permitted with the express written permission of u-blox.

The information contained herein is provided "as is" and u-blox assumes no liability for its use. No warranty, either express or implied, is given, including but not limited to, with respect to the accuracy, correctness, reliability and fitness for a particular purpose of the information. This document may be revised by u-blox at any time without notice. For the most recent documents, visit [www.u-blox.com](http://www.u-blox.com).

Copyright © u-blox AG.

# Contents

<b>Document Information</b> .....	<b>2</b>
<b>Contents</b> .....	<b>3</b>
<b>1 Functional description</b> .....	<b>5</b>
1.1 Overview .....	5
1.2 Product features .....	5
1.3 Performance.....	6
1.4 Block diagram .....	7
1.5 Supported GNSS constellations .....	7
1.5.1 GPS .....	7
1.5.2 GLONASS .....	8
1.5.3 BeiDou .....	8
1.5.4 Galileo .....	8
1.6 Assisted GNSS (A-GNSS).....	8
1.6.1 AssistNow™ Online.....	8
1.6.2 AssistNow™ Offline .....	9
1.6.3 AssistNow™ Autonomous .....	9
1.7 Augmentation Systems .....	9
1.7.1 Satellite-Based Augmentation System (SBAS) .....	9
1.7.2 QZSS .....	9
1.7.3 IMES .....	10
1.7.4 Differential GPS (D-GPS).....	10
1.8 Broadcast navigation data and satellite signal measurements .....	10
1.9 Odometer .....	10
1.10 Geofencing.....	10
1.11 Message Integrity Protection.....	11
1.12 Spoofing detection .....	11
1.13 EXTINT: External interrupt.....	11
1.13.1 Power control.....	11
1.13.2 Aiding .....	11
1.14 TIMEPULSE .....	11
1.15 Protocols and interfaces .....	12
1.16 Interfaces.....	12
1.16.1 UART .....	12
1.16.2 USB .....	12
1.16.3 SPI .....	12
1.16.4 Display Data Channel (DDC) .....	12
1.17 Clock generation.....	13
1.17.1 Oscillators .....	13
1.17.2 Real-Time Clock (RTC) .....	13
1.18 Power management .....	13

1.18.1 DC/DC converter .....	13
1.18.2 Power Mode Setup.....	13
1.18.3 Continuous Mode.....	14
1.18.4 Power Save Mode.....	14
1.19 Antenna.....	14
1.19.1 Antenna supervision .....	14
<b>2 Pin definition .....</b>	<b>15</b>
2.1 Pin assignment.....	15
<b>3 Configuration management.....</b>	<b>17</b>
3.1 Interface Selection (D_SEL) .....	17
<b>4 Electrical specification .....</b>	<b>18</b>
4.1 Absolute maximum rating.....	18
4.2 Operating conditions.....	19
4.3 Indicative current requirements .....	19
4.4 SPI timing diagrams .....	20
4.4.1 Timing recommendations.....	20
4.5 DDC timing diagrams .....	20
<b>5 Mechanical specifications .....</b>	<b>21</b>
<b>6 Reliability tests and approvals.....</b>	<b>22</b>
6.1 Reliability tests.....	22
6.2 Approvals .....	22
<b>7 Product handling &amp; soldering.....</b>	<b>23</b>
7.1 Packaging .....	23
7.1.1 Reels .....	23
7.1.2 Tapes.....	23
7.2 Shipment, storage and handling .....	24
7.2.1 Moisture Sensitivity Levels .....	24
7.2.2 Reflow soldering.....	24
7.2.3 ESD handling precautions .....	24
<b>8 Default messages .....</b>	<b>25</b>
<b>9 Labeling and ordering information .....</b>	<b>26</b>
9.1 Product labeling.....	26
9.2 Explanation of codes .....	26
9.3 Ordering codes.....	26
<b>Appendix .....</b>	<b>27</b>
<b>A Glossary .....</b>	<b>27</b>
<b>Related documents .....</b>	<b>28</b>
<b>Revision history .....</b>	<b>28</b>
<b>Contact.....</b>	<b>29</b>

# 1 Functional description

## 1.1 Overview

The NEO-M8Q-01A is a ROM-based automotive grade concurrent GNSS module, targeted for use in hazardous environments such as automotive applications.

The module is built on the exceptional performance of the u-blox M8 GNSS engine in the industry proven NEO form factor. It utilizes concurrent reception of up to three GNSS systems (GPS/Galileo together with BeiDou or GLONASS) for more reliable positioning.

The NEO-M8Q-01A provides high sensitivity and minimal acquisition times while maintaining low system power. The automotive grade module is optimized for applications where an extended operational temperature range (-40 °C to +105 °C) is required. The sophisticated RF architecture and interference suppression ensure maximum performance even in GNSS-hostile environments.

The NEO-M8Q-01A combines a high level of robustness and integration capability along with flexible connectivity options via USB, I2C UART and SPI. The DDC (I<sup>2</sup>C compatible) interface provides connectivity and enables synergies with most u-blox cellular modules.

With sophisticated message signature capabilities and spoofing detection, the NEO-M8Q-01A automotive grade module offers high protection against malicious positioning interference.

The NEO-M8Q-01A module uses GNSS chips qualified according to AEC-Q100. The modules are manufactured in ISO/TS 16949 certified sites and fully tested on a system level. Qualification tests are performed as stipulated in the ISO16750 standard: "Road vehicles – Environmental conditions and testing for electrical and electronic equipment". This automotive grade product adheres to automotive industry standard quality specifications and production flow.

u-blox's AssistNow service supplies aiding information, such as ephemeris, almanac, rough last position and time, reducing the time-to-first-fix significantly and improving the acquisition sensitivity. AssistNow data with u-blox M8 modules supports GPS, BeiDou and GLONASS constellations for faster acquisition than a GPS-only assistance. The extended validity of AssistNow Offline data (up to 35 days) provides faster acquisition after long off time. AssistNow Autonomous can calculate GPS-only orbit predictions for up to 3 days.

See section 1.6 for more information concerning the NEO-M8Q-01A related AssistNow service.

## 1.2 Product features

Model	Category	GNSS	Supply	Interfaces	Features	Grade
	Standard Precision GNSS High Precision GNSS Dead Reckoning Timing	GPS/QZSS GLONASS Galileo BeiDou Number of concurrent GNSS	2.7 V – 3.6 V	UART USB SPI DDC (I <sup>2</sup> C compliant)	Programmable (flash) Data logging Additional SAW Additional LNA RTC crystal Oscillator Built-in antenna Built-in antenna supply and supervisor Timepulse	Standard Professional Automotive
NEO-M8Q-01A*	●	● ● ● ● 3	●	● ● ● ●	● T ● 1	●

● = Operating temperature -40 °C to +105 °C

C = Crystal / T = TCXO

## 1.3 Performance

 All specifications are at an ambient temperature of +25 °C. Extreme operating temperatures can significantly impact specification values. Applications operating near the temperature limits should be tested to ensure the specification.

Parameter	Specification					
Receiver type	72-channel u-blox M8 engine GPS L1C/A, SBAS L1C/A, QZSS L1C/A, QZSS L1 SAIF, GLONASS L1OF, BeiDou B1I, Galileo E1B/C					
Accuracy of time pulse signal	RMS	30 ns				
	99%	60 ns				
Frequency of time pulse signal	0.25 Hz...10 MHz (configurable)					
Operational limits <sup>1</sup>	Dynamics	≤ 4 g				
	Altitude	50,000 m				
	Velocity	500 m/s				
Velocity accuracy <sup>2</sup>	0.05 m/s					
Heading accuracy <sup>2</sup>	0.3 degrees					
GNSS	GPS & GLONASS	GPS	GLONASS	BeiDou	Galileo	
Horizontal position accuracy <sup>3</sup>	2.5 m	2.5 m	4 m	3 m	TBC <sup>4</sup>	
Max navigation update rate	10 Hz	18 Hz	18 Hz	18 Hz	18 Hz	
Time-To-First-Fix <sup>5</sup>	Cold start	26 s	29 s	30 s	34 s	45 s
	Hot start	1 s	1 s	1 s	1 s	1 s
	Aided starts <sup>6</sup>	2 s	2 s	2 s	3 s	7 s
Sensitivity <sup>7</sup>	Tracking & Navigation	-167 dBm	-166 dBm	-166 dBm	-160 dBm	-159 dBm
	Reacquisition	-160 dBm	-160 dBm	-156 dBm	-157 dBm	-153 dBm
	Cold start	-148 dBm	-148 dBm	-145 dBm	-143 dBm	-138 dBm
	Hot start	-157 dBm	-157 dBm	-156 dBm	-155 dBm	-151 dBm

**Table 1: NEO-M8Q-01A performance in different GNSS modes (default: concurrent reception of GPS and GLONASS including QZSS, SBAS)**

<sup>1</sup> Assuming Airborne < 4 g platform

<sup>2</sup> 50% @ 30 m/s

<sup>3</sup> CEP, 50%, 24 hours static, -130 dBm, > 6 SVs

<sup>4</sup> To be confirmed when Galileo reaches full operational capability

<sup>5</sup> All satellites at -130 dBm, except Galileo at -127 dBm

<sup>6</sup> Dependent on aiding data connection speed and latency

<sup>7</sup> Demonstrated with a good external LNA

## 1.4 Block diagram

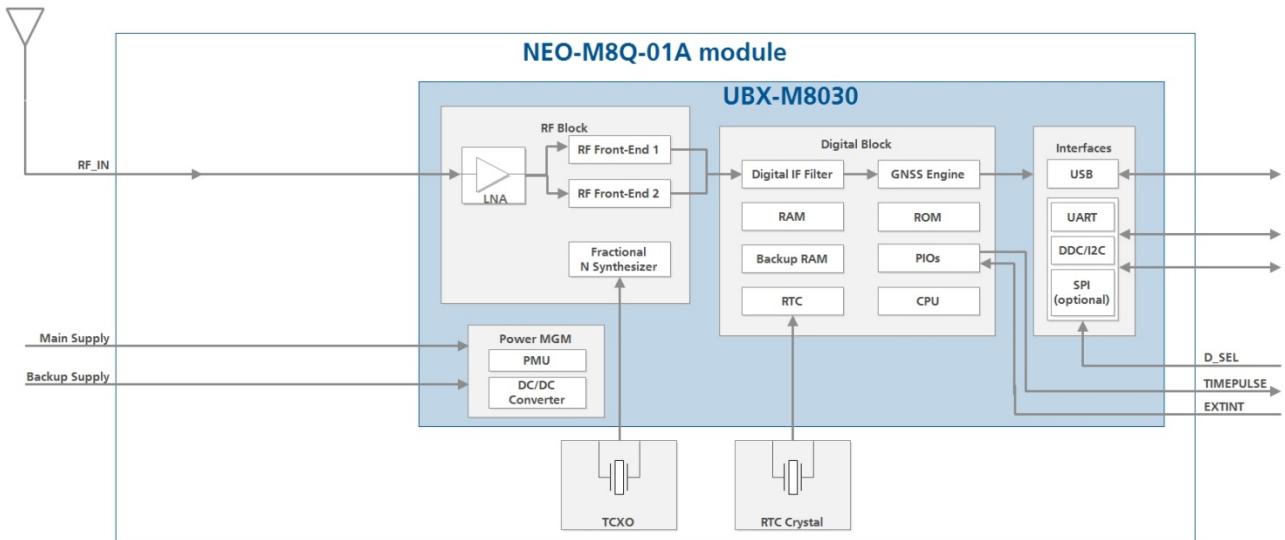

Figure 1: NEO-M8Q-01A block diagram

## 1.5 Supported GNSS constellations

The NEO-M8Q-01A GNSS module is a concurrent GNSS receiver which can receive and track multiple GNSS systems: GPS, Galileo, GLONASS and BeiDou. Owing to the dual-frequency RF front-end architecture, either GLONASS or BeiDou can be processed concurrently with GPS and Galileo signals providing reception of three GNSS systems. By default, the M8 receivers are configured for concurrent GPS and GLONASS, including SBAS and QZSS reception. If power consumption is a key factor, then the receiver should be configured for a single GNSS operation using GPS, Galileo, GLONASS or BeiDou and disabling QZSS and SBAS.

The module can be configured to receive any single GNSS constellation or within the set of permissible combinations shown below.

GPS	Galileo	GLONASS	BeiDou
•	•	–	–
•	•	•	–
•	•	–	•
•	–	•	–
•	–	–	•
–	•	•	–
–	•	–	•
–	–	•	•

Table 2 Permissible GNSS combinations (• = enabled)

- The augmentation systems: SBAS and QZSS can be enabled only if GPS operation is configured. QZSS should be enabled whenever GPS operation is configured.
- Galileo is not enabled as the default configuration.

### 1.5.1 GPS

The NEO-M8Q-01A positioning module is designed to receive and track the L1C/A signals provided at 1575.42 MHz by the Global Positioning System (GPS).

## 1.5.2 GLONASS

The NEO-M8Q-01A module can receive and process the GLONASS satellite system as an alternative to the US-based Global Positioning System (GPS). u-blox's NEO-M8 positioning module is designed to receive and track the L1OF signals GLONASS provides at 1602 MHz +  $k \cdot 562.5$  kHz, where  $k$  is the satellite's frequency channel number ( $k = -7, \dots, 5, 6$ ). The ability to receive and track GLONASS L1OF satellite signals allows design of GLONASS receivers where required by regulations.

To take advantage of GPS and GLONASS, dedicated hardware preparation must be made during the design-in phase. See the NEO-M8Q-01A Hardware Integration Manual [1] for the u-blox design recommendations.

## 1.5.3 BeiDou

The NEO-M8Q-01A module can receive and process the B1I signals broadcast at 1561.098 MHz from the BeiDou Navigation Satellite System. The ability to receive and track BeiDou signals in conjunction with another constellation results in higher coverage, improved reliability and better accuracy. Currently, BeiDou is not fully operational globally and provides Chinese regional coverage only. Global coverage is scheduled for 2020.

## 1.5.4 Galileo

The NEO-M8Q-01A module can receive and track the E1-B/C signals centered on the GPS L1 frequency band. GPS and Galileo signals can be processed concurrently together with either BeiDou or GLONASS signals, enhancing coverage, reliability and accuracy. The SAR return link message (RLM) parameters for both short and long versions are decoded by the receiver and made available to users via UBX proprietary messages.

 Galileo has been implemented according to ICD release 1.3 (December 2016). Since the Galileo satellite system has only recently reached Initial Services (IS) and does not yet offer Full Operational Capability (FOC), changes to the Galileo signal specification (OS SIS ICD) remain theoretically possible. u-blox therefore recommends using Flash memory in designs utilizing Galileo signals in order to allow for a firmware update in the unlikely event of change to the Galileo signal specification (OS SIS ICD).

 Galileo reception is disabled by default, but can be enabled by sending a configuration message (UBX-CFG-GNSS) to the receiver. See the u-blox 8 / u-blox M8 Receiver Description Including Protocol Specification [2] for more information.

## 1.6 Assisted GNSS (A-GNSS)

Supply of GNSS receiver assistance information, such as ephemeris, almanac, rough user position and time, will reduce the time to first fix significantly and improve acquisition sensitivity. The NEO-M8Q-01A module supports the u-blox AssistNow Online and AssistNow Offline A-GNSS services, supports AssistNow Autonomous, and is OMA SUPL compliant.

### 1.6.1 AssistNow™ Online

With AssistNow Online, an internet connected host downloads assistance data from the u-blox AssistNow Online service to the receiver at system start-up. The Multi-GNSS Assistance (MGA) service is an HTTP protocol based network operator independent service.

Supplying assistance information, such as ephemeris, almanac, a rough last position and time, can reduce the time to first fix significantly and improve acquisition sensitivity.

 The AssistNow Online service provides data for GPS, GLONASS, BeiDou and QZSS



## 1.6.2 AssistNow™ Offline

With the AssistNow Offline service, users can download long-term orbit data over the internet at their convenience. The orbit data can be stored in the memory of the application processor and transmitted by the host processor during startup. The function requires no connectivity at system start-up, enabling a position fix within seconds, even when no network is available. AssistNow Offline offers augmentation for up to 35 days.

 AssistNow Offline service provides data for GPS and GLONASS. BeiDou and Galileo satellites on circular and near-circular orbits are also supported. It will not consider satellites on orbits with an eccentricity of  $> 0.05$  (e.g. E18). QZSS is not supported. The performance of the predicted orbits for Galileo cannot be guaranteed due to the immature state of the Galileo deployment at firmware release.

## 1.6.3 AssistNow™ Autonomous

AssistNow Autonomous provides aiding information without the need for a host or external network connection. Based on previous broadcast satellite ephemeris data downloaded to and stored by the GNSS receiver, AssistNow Autonomous automatically generates accurate predictions of satellite orbital data (“AssistNow Autonomous data”) that is usable for future GNSS position fixes. The concept capitalizes on the periodic nature of GNSS satellites; by capturing strategic ephemeris data at specific times of the day, the receiver can predict accurate GPS-only satellite ephemeris for up to 3 days after initial reception.

u-blox’s AssistNow Autonomous benefits are:

- Faster fix in situations where GNSS satellite signals are weak
- No connectivity required
- Compatible with AssistNow Online (can work stand-alone, or in tandem with the AssistNow Online service)
- No integration effort; calculations are done in the background, transparent to the user.

 For more details, see the u-blox 8 / u-blox M8 Receiver Description Including Protocol Specification [\[2\]](#).

# 1.7 Augmentation Systems

## 1.7.1 Satellite-Based Augmentation System (SBAS)

The NEO-M8Q-01A module supports reception of SBAS broadcast signals. These systems supplement GNSS data with additional regional or wide area GPS augmentation data. The system broadcasts range correction and integrity information via satellite which can be used by GNSS receivers to improve their resulting precision. SBAS satellites can be used as additional satellites for ranging (navigation), further enhancing availability. The following SBAS types are supported: GAGAN, WAAS, EGNOS and MSAS.

 For more details, see the u-blox 8 / u-blox M8 Receiver Description Including Protocol Specification [\[2\]](#).

## 1.7.2 QZSS

The Quasi-Zenith Satellite System (QZSS) is a regional navigation satellite system that transmits additional GPS L1 C/A signals for the Pacific region covering Japan and Australia. The NEO-M8Q-01A positioning module is able to receive and track these signals concurrently with GPS signals, resulting in better availability especially under challenging signal conditions, e.g. in urban canyons. The L1-SAIF signal provided by QZSS can be enabled for reception via a GNSS configuration message.

### 1.7.3 IMES

The Japanese Indoor Messaging System (IMES) system is used for indoor position reporting using low-power transmitters which broadcast a GPS-like signal. The NEO-M8Q-01A module can be configured to receive and demodulate the signal to provide an indoor location estimate.

 This service is authorized and available only in Japan.

 IMES reception is disabled by default

### 1.7.4 Differential GPS (D-GPS)

The NEO-M8Q-01A receiver supports differential GPS data according to RTCM 10402.3: “RECOMMENDED STANDARDS FOR DIFFERENTIAL GNSS”. The use of differential GPS data improves GPS position accuracy. RTCM cannot be used together with SBAS. The RTCM implementation supports the following RTCM 2.3 messages:

Message Type	Description
1	Differential GPS Corrections
2	Delta Differential GPS Corrections
3	GPS Reference Station Parameters
9	GPS Partial Correction Set

**Table 3: Supported RTCM 2.3 messages**

 For more details, see the u-blox 8 / u-blox M8 Receiver Description Including Protocol Specification [2].

## 1.8 Broadcast navigation data and satellite signal measurements

The NEO-M8Q-01A can output all the GNSS broadcast data upon reception from tracked satellites. This includes all the supported GNSS signals plus the augmentation services SBAS, QZSS and IMES. The receiver also makes available the tracked satellite signal information, i.e. raw code phase and Doppler measurements in a form aligned to the Radio Resource LCS Protocol (RRLP) [6]. For more details, see the u-blox 8 / u-blox M8 Receiver Description Including Protocol Specification [2].

### 1.9 Odometer

The odometer provides information on travelled ground distance (in meters) using solely the position and Doppler-based velocity of the navigation solution. For each computed travelled distance since the last odometer reset, the odometer estimates a 1-sigma accuracy value. The total cumulative ground distance is maintained and saved in the BBR memory.

 The odometer feature is disabled by default. For more details, see the u-blox 8 / u-blox M8 Receiver Description Including Protocol Specification [2].

### 1.10 Geofencing

The u-blox NEO-M8Q-01A module supports up to four circular geofencing areas defined on the Earth’s surface using a 2D model. Geofencing is active when at least one geofence is defined, the current status can be found by polling the receiver. A GPIO pin can be nominated to indicate status to, e.g. wake up a host on activation.

## 1.11 Message Integrity Protection

The NEO-M8Q-01A provides a function to detect third party interference with the UBX message stream sent from receiver to host. The security mechanism “signs” nominated messages via a subsequent UBX message. This message signature is then compared with one generated by the host to determine if the message data has been altered. The signature algorithm seed can use one fixed secret ID key set by eFuse in production and a dynamic ID key set by the host, enabling users to detect “man-in-the-middle” style attacks.

## 1.12 Spoofing detection

Spoofing is a process whereby a malicious third party tries to control the reported position via a “fake” GNSS broadcast signal. This may result in the form of reporting an incorrect position, velocity or time. To combat against this, the NEO-M8Q-01A module includes spoofing detection measures to alert the host when signals appear to be suspicious. The receiver combines a number of checks on the received signals looking for inconsistencies across several parameters.

 This feature does not guarantee the detection of all spoofing attacks.

## 1.13 EXTINT: External interrupt

**EXTINT** is an external interrupt pin with fixed input voltage thresholds with respect to **VCC**. It can be used for control of the receiver or for aiding.

For more information about how to implement and configure these features, see the u-blox 8 / u-blox M8 Receiver Description including Protocol Specification [2] and the NEO-M8Q-01A Hardware Integration Manual [1].

### 1.13.1 Power control

The power control feature allows overriding the automatic active/inactive cycle of Power Save Mode. The state of the receiver can be controlled through an **EXTINT** pin.

The receiver can also be forced OFF using **EXTINT** when Power Save Mode is not active.

### 1.13.2 Aiding

The **EXTINT** pin can be used to supply time or frequency aiding data to the receiver.

For time aiding, hardware time synchronization can be achieved by connecting an accurate time pulse to the **EXTINT** pin.

Frequency aiding can be implemented by connecting a periodic rectangular signal with a frequency up to 500 kHz and arbitrary duty cycle (low/high phase duration must not be shorter than 50 ns) to the **EXTINT** pin. Provide the applied frequency value to the receiver using UBX messages.

## 1.14 TIMEPULSE

A configurable time pulse signal is available on the NEO-M8Q-01A receiver.

The **TIMEPULSE** output generates pulse trains synchronized with GPS or UTC time grid with intervals configurable over a wide frequency range. Thus it may be used as a low frequency time synchronization pulse or as a high frequency reference signal.

By default the time pulse signal is configured to 1 pulse per second. For more information, see the u-blox 8 / u-blox M8 Receiver Description including Protocol Specification [2].

## 1.15 Protocols and interfaces

Protocol	Type
NMEA 0183, version 4.0 (V2.3 or V4.1 configurable)	Input/output, ASCII
UBX	Input/output, binary, u-blox proprietary
RTCM	Input message, 1, 2, 3, 9

**Table 4: Available Protocols**

All protocols are available on UART, USB, DDC (I<sup>2</sup>C compliant) and SPI. For specification of the various protocols, see the u-blox 8 / u-blox M8 Receiver Description Including Protocol Specification [2].

## 1.16 Interfaces

A number of interfaces are provided either for data communication or memory access. The embedded firmware uses these interfaces according to their respective protocol specifications.

### 1.16.1 UART

The NEO-M8Q-01A module includes one UART interface, which can be used for communication to a host. It supports configurable baud rates. For supported baud rates, see the u-blox 8 / u-blox M8 Receiver Description Including Protocol Specification [2].

 Designs must allow access to the UART and the **SAFEBOOT\_N** function pin for future service and reconfiguration.

### 1.16.2 USB

A USB interface, which is compatible to USB version 2.0 FS (Full Speed, 12 Mbit/s), can be used for communication as an alternative to the UART. The pull-up resistor on pin **USB\_DP** is integrated to signal a full-speed device to the host. The **VDD\_USB** pin supplies the USB interface. The u-blox USB (CDC-ACM) driver supports Windows Vista, Windows 7 and Windows 8 operating systems. A separate driver (CDC-ACM) is not required for Windows 10 which has a built-in USB-serial driver. However, plugging initially into an internet connected Windows 10 PC, will download the u-blox combined sensor and VCP driver package.

USB drivers can be downloaded from the u-blox web site, [www.u-blox.com](http://www.u-blox.com).

### 1.16.3 SPI

The SPI interface is designed to allow communication to a host CPU. The interface can be operated in slave mode only. The maximum transfer rate using SPI is 125 kB/s and the maximum SPI clock frequency is 5.5 MHz, see Figure 3: SPI timing diagram.

Note that SPI is not available in the default configuration, because its pins are shared with the UART and DDC interfaces. The SPI interface can be enabled by connecting **D\_SEL** (pin 2) to ground (see section 3.1). In this case the DDC interface for data communication is no longer available.

### 1.16.4 Display Data Channel (DDC)

An I<sup>2</sup>C compliant DDC interface is available for communication with an external host CPU or u-blox cellular modules. The interface can be operated in slave mode only. The DDC protocol and electrical interface are fully compatible with Fast-Mode of the I<sup>2</sup>C industry standard. Since the maximum SCL clock frequency is 400 kHz, the maximum transfer rate is 400 kbit/s.

## 1.17 Clock generation

### 1.17.1 Oscillators

NEO-M8Q-01A GNSS module is equipped with a TCXO. The TCXO allows accelerated weak signal acquisition, enabling faster start and reacquisition times.

Oscillators used on NEO-M8Q-01A module are carefully selected and screened for stability and against frequency perturbations across the full operating range (−40 °C to +105 °C).

The careful selection and qualification of critical parts, such as GNSS oscillators, has resulted in u-blox modules being the most reliable positioning modules in the industry, particularly in challenging conditions.

### 1.17.2 Real-Time Clock (RTC)

The RTC is driven by a 32 kHz oscillator using an RTC crystal. If the main supply voltage fails, and a battery is connected to **V\_BCKP**, parts of the receiver switch off, but the RTC still runs providing a timing reference for the receiver. This operating mode is called Hardware Backup Mode, which enables all relevant data to be saved in the backup RAM to allow a hot or warm start later.

## 1.18 Power management

u-blox M8 technology offers a power-optimized architecture with built-in autonomous power saving functions to minimize power consumption at any given time. Furthermore, the receiver can be used in two operating modes: Continuous mode for best performance or Power Save Mode for optimized power consumption respectively.

### 1.18.1 DC/DC converter

The NEO-M8Q-01A module integrates a DC/DC converter, allowing reduced power consumption.



For more information, see the NEO-M8Q-01A Hardware Integration Manual [\[1\]](#).

### 1.18.2 Power Mode Setup

NEO-M8Q-01A can be configured to run in either continuous or a choice of Power Save mode configurations. A template of power mode settings can be used to easily select typical power mode setups to cover the majority of users' requirements.

For specific power saving applications the user has the option to fully configure via the power save mode configuration. For more information, see section [1.18.4](#).

The NEO-M8Q-01A's power mode setup offers a choice of continuous operation and preset Power Save Mode configurations.

- Continuous (default) mode for best GNSS performance vs. power consumption
- Continuous mode with no compromise in power consumption
- A 1 Hz cyclic tracking mode for aggressive power reduction
- Choice of 2 Hz or 4 Hz<sup>8</sup> cyclic tracking modes for typical wearable applications
- ON/OFF interval mode

---

<sup>8</sup> Single GNSS constellation configuration only

### 1.18.3 Continuous Mode

Continuous Mode uses the acquisition engine at full performance resulting in the shortest possible TTFF and the highest sensitivity. It searches for all possible satellites until the almanac is completely downloaded. The receiver then switches to the tracking engine to reduce power consumption.

Thus, a lower tracking current consumption level will be achieved when:

A valid GNSS position is obtained

The entire almanac has been downloaded

The ephemeris for each satellite in view is valid

### 1.18.4 Power Save Mode

For specific power saving applications outside the typical preset power mode setups, users can configure a tailored Power Save Mode.

Power Save Mode provides two dedicated methods, ON/OFF and Cyclic tracking, that reduce average current consumption in different ways to match the needs of the specific application. These operations can be set by using a specific UBX message.

 For more information about power management strategies, see the u-blox 8 / u-blox M8 Receiver Description Including Protocol Specification [\[2\]](#).

## 1.19 Antenna

The NEO-M8Q-01A module is designed for use with an active<sup>9</sup> antenna. A passive antenna can be used, but an external SAW and LNA are required for optimal operation.

Parameter	Specification	
Antenna type	Active antenna	
Active antenna recommendations	Minimum gain	15 dB (to compensate signal loss in RF cable)
	Maximum gain	50 dB
	Maximum noise figure	1.5 dB

**Table 5: Antenna Specifications for NEO-M8Q-01A module**

### 1.19.1 Antenna supervision

The NEO-M8Q-01A outputs a filtered **VCC** on **VCC\_RF** for a nominal 3 V antenna supply.

The NEO-M8Q-01A provides the antenna supervisor signals Active Antenna Control (**ANT\_OFF**), Open Circuit Detection (**PIO14 / ANT\_DET**) and Short Circuit Detection (**ANT\_OK**), thus allowing an external circuit to check the antenna for open and short circuits and to shut off the antenna supply if a short circuit is detected or whenever it is not needed. This feature helps to reduce power consumption in Power Save Mode. Antenna supervision is configurable using a UBX-CFG-ANT message.

 Refer to the u-blox 8 / u-blox M8 Receiver Description Including Protocol Specification [\[2\]](#) for information about further settings.

 For more information, see the NEO-M8Q-01A Hardware Integration Manual [\[1\]](#).

<sup>9</sup> For information on using active antennas, see the NEO-M8Q-01A Hardware Integration Manual [\[1\]](#)

## 2 Pin definition

### 2.1 Pin assignment

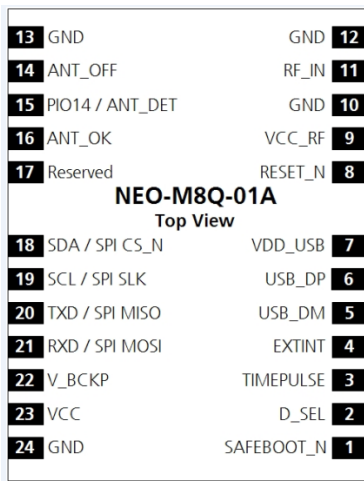



PIO = Peripheral Input Output

Figure 2: Pin assignment

No	Name	PIO No.	I/O	Description
1	SAFEBOOT_N	-	I	SAFEBOOT_N (for future service and reconfiguration)
2	D_SEL	-	I	Interface select
3	TIMEPULSE	11	O	Time pulse (1PPS)
4	EXTINT	13	I	External Interrupt Pin
5	USB_DM	-	I/O	USB Data
6	USB_DP	-	I/O	USB Data
7	VDD_USB	-	I	USB Supply
8	RESET_N	-	I	RESET_N
9	VCC_RF	-	O	Output Voltage RF section
10	GND	-	I	Ground
11	RF_IN	-	I	GNSS signal input
12	GND	-	I	Ground
13	GND	-	I	Ground
14	ANT_OFF	16	O	Active Antenna Control (ANT_OFF)
15	PIO14 / ANT_DET	14	I	Open Circuit Detection (PIO14 / ANT_DET)
16	ANT_OK	15	I	Short Circuit Detection (ANT_OK)
17	Reserved	-	-	Reserved, leave open
18	SDA / SPI CS_N	9	I/O	DDC Data if D_SEL = 1 (or open) SPI Chip Select if D_SEL = 0
19	SCL / SPI CLK	8	I	DDC Clock if D_SEL = 1 (or open) SPI Clock if D_SEL = 0
20	TXD / SPI MISO	6	O	Serial Port if D_SEL = 1 (or open) SPI MISO if D_SEL = 0
21	RXD / SPI MOSI	7	I	Serial Port if D_SEL = 1 (or open) SPI MOSI if D_SEL = 0
22	V_BCKP	-	I	Backup voltage supply
23	VCC	-	I	Supply voltage
24	GND	-	I	Ground

Table 6: Pinout

-  For more information about the pinout, see the NEO-M8Q-01A Hardware Integration Manual [\[1\]](#).
-  To configure the antenna supervisor, use the UBX-CFG-ANT message. For further information, see the u-blox 8 / u-blox M8 Receiver Description Including Protocol Specification [\[2\]](#).



## 3 Configuration management

Configuration settings can be modified with UBX configuration messages. The modified settings remain effective until power-down or reset. If these settings have been stored in battery-backup RAM, then the modified configuration will be retained, as long as the backup battery supply is not interrupted.

### 3.1 Interface Selection (D\_SEL)

At start-up, pin 2 (**D\_SEL**) determines which data interfaces are used for communication. If **D\_SEL** is set high or left open, UART and DDC become available. If **D\_SEL** is set low, i.e. connected to ground, the NEO-M8Q-01A module can communicate to a host via SPI.

PIN #	D_SEL="1" (left open)	D_SEL="0" (connected to GND)
20	UART TX	SPI MISO
21	UART RX	SPI MOSI
19	DDC SCL	SPI CLK
18	DDC SDA	SPI CS_N

**Table 7: Data interface selection by D\_SEL**

## 4 Electrical specification

 The limiting values given are in accordance with the Absolute Maximum Rating System (IEC 134). Stress above one or more of the limiting values may cause permanent damage to the device. These are stress ratings only, and operation of the device at these or at any other conditions above those given in the characteristics sections of the specification is not implied. Exposure to these limits for extended periods may affect device reliability.

 Where application information is given, it is advisory only and does not form part of the specification. For more information, see the NEO-M8Q-01A Hardware Integration Manual [1].

### 4.1 Absolute maximum rating

Parameter	Symbol	Condition	Min	Max	Units
Power supply voltage	VCC		-0.5	3.6	V
Backup battery voltage	V_BCKP		-0.5	3.6	V
USB supply voltage	VDD_USB		-0.5	3.6	V
Input pin voltage	V <sub>IN</sub>	If VCC < 3.1V	-0.5	VCC+0.5	V
		If VCC >= 3.1V	-0.5	3.6	
	V <sub>IN_USB</sub>		-0.5	VDD_USB	V
DC current through any digital I/O pin (except supplies)	I <sub>PIN</sub>			10	mA
VCC_RF output current	I <sub>CC_RF</sub>			100	mA
Input power at RF_IN	P <sub>RFIN</sub>	source impedance = 50 Ω, continuous wave		15	dBm
Storage temperature	T <sub>STG</sub>		-40	105	°C

**Table 8: Absolute maximum ratings**

 Stressing the device beyond the “Absolute Maximum Ratings” may cause permanent damage. These are stress ratings only. The product is not protected against overvoltage or reversed voltages. If necessary, voltage spikes exceeding the power supply voltage specification, given in table above, must be limited to values within the specified boundaries by using appropriate protection diodes.

## 4.2 Operating conditions

All specifications are at an ambient temperature of +25 °C. Extreme operating temperatures can significantly impact specification values. Applications operating near the temperature limits should be tested to ensure the specification.

Parameter	Symbol	Min	Typical	Max	Units	Condition
Power supply voltage	VCC	2.7	3.0	3.6	V	
Supply voltage USB	VDD_USB	3.0	3.3	3.6	V	
Backup battery voltage	V_BCKP	1.4		3.6	V	
Backup battery current	I_BCKP		15		μA	V_BCKP = 1.8 V, VCC = 0 V
SW backup current	I_SWBCKP		20		μA	VCC = 3 V
Input pin voltage range	V <sub>IN</sub>	0		VCC	V	
Digital IO Pin Low level input voltage	V <sub>IL</sub>	0		0.2*VCC	V	
Digital IO Pin High level input voltage	V <sub>IH</sub>	0.7*VCC		VCC	V	
Digital IO Pin Low level output voltage	V <sub>OL</sub>			0.4	V	I <sub>OL</sub> = 4 mA
Digital IO Pin High level output voltage	V <sub>OH</sub>	VCC-0.4			V	I <sub>OH</sub> = 4 mA
Pull-up resistor for RESET_N	R <sub>PU</sub>		11		kΩ	
USB_DM, USB_DP	V <sub>INU</sub>	Compatible with USB with 27 Ω series resistance				
VCC_RF voltage	V <sub>CC_RF</sub>		VCC-0.1		V	
VCC_RF output current	I <sub>CC_RF</sub>			50	mA	
Receiver Chain Noise Figure <sup>10</sup>	NF <sub>TOT</sub>		3.5		dB	
Ambient temperature	T <sub>AMB</sub>	-40		+105	°C	

**Table 9: Operating conditions**

Operation beyond the specified operating conditions can affect device reliability.

## 4.3 Indicative current requirements

Table 10 lists examples of the total system supply current for a possible application.

Values in Table 10 are provided for customer information only as an example of typical power requirements. Values are characterized on samples, actual power requirements can vary depending on firmware version used, external circuitry, number of satellites tracked, signal strength, type of start as well as time, duration and conditions of test.

Parameter	Symbol	Typ: GPS & GLONASS / QZSS / SBAS	Typ: GPS / QZSS / SBAS	Max	Units	Condition
Max. supply current 11	I <sub>CCP</sub>			67	mA	
Average supply current 12, 13	I <sub>CC</sub> Acquisition	24	19		mA	Estimated at 3 V
	I <sub>CC</sub> Tracking (continuous mode)	22	17		mA	Estimated at 3 V
	I <sub>CC</sub> Tracking (Power Save mode / 1 Hz)	6.3	5.8		mA	Estimated at 3 V

**Table 10: Indicative power requirements at 3.0 V**

<sup>10</sup> Only valid for the GPS band

<sup>11</sup> Use this figure to dimension maximum current capability of power supply. Measurement of this parameter is with 1 Hz bandwidth.

<sup>12</sup> Use this figure to determine required battery capacity.

<sup>13</sup> Simulated GNSS constellation using power levels of -130 dBm. VCC = 3.0 V

<sup>14</sup> Average current from start-up until the first fix.

For more information about power requirements, see the NEO-M8Q-01A Hardware Integration Manual [1].

For more information on how to noticeably reduce current consumption, see the Power Management Application Note [4].

## 4.4 SPI timing diagrams

In order to avoid incorrect operation of the SPI, the user needs to comply with certain timing conditions. The following signals need to be considered for timing constraints:

Symbol	Description
SPI CS_N (SS_N)	Slave select signal
SPI CLK (SCK)	Slave clock signal

Table 11: Symbol description

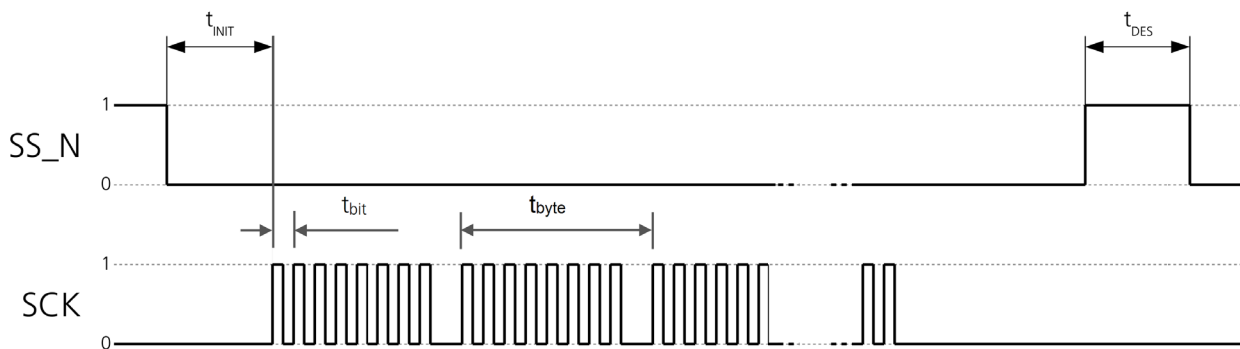

Figure 3: SPI timing diagram

### 4.4.1 Timing recommendations

Parameter	Description	Recommendation
$t_{INIT}$	Minimum initialization time	10 $\mu$ s
$t_{DES}$	Deselect time	1 ms
$t_{bit}$	Minimum bit time	180 ns (5.5 MHz max bit frequency)
$t_{byte}$	Minimum byte period	8 $\mu$ s (125 kHz max byte frequency)

Table 12: SPI timing recommendations

The values in the above table result from the requirement of an error-free transmission. By allowing just a few errors and disabling the glitch filter, the bit rate can be increased considerably.

## 4.5 DDC timing diagrams

The DDC interface is I<sup>2</sup>C Fast Mode compliant. For timing parameters, consult the I<sup>2</sup>C standard.

The maximum bit rate is 400 kbit/s. The interface stretches the clock when slowed down when serving interrupts, so real bit rates may be slightly lower.

## 5 Mechanical specifications

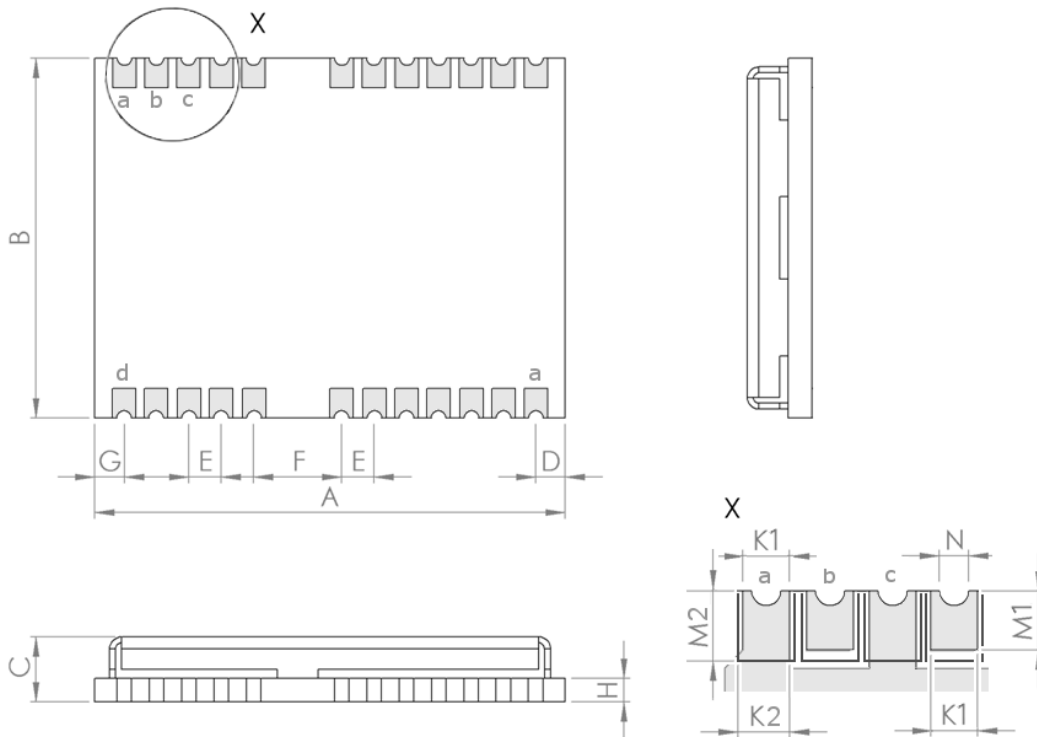

Symbol	Description	Min. (mm)	Typ. (mm)	Max. (mm)
A	Module height	15.9	16.0	16.6
B	Module width	12.1	12.2	12.3
C	Module total thickness	2.2	2.4	2.6
D, G	Horizontal edge to pad pitch	0.9	1.0	1.3
E	Pad to pad pitch	1.0	1.1	1.2
F	Gap width	2.9	3.0	3.1
H	Module PCB thickness		0.82	
K1	Pad width (metal)	0.7	0.8	0.9
K2	Pad width (metal / solder mask)	0.7	0.8/0.9	0.9/1.2
M1	Pad height (metal)	0.7	0.8	0.9
M2	Pad height (solder mask)	0.7	0.9	1.1
N	Pad half-moon diameter	0.4	0.5	0.6
	Module weight (g)		1.6	

**Figure 4: Dimensions**



Ground pad “c” is of rectangular shape. Height of this pad (M2) is defined by the half moon and the solder mask. Width of this pad is defined by the metal.

Ground pads “a” and “d” on the corners of the module have pedestal shape. They have a rectangular extension at the outer edge connecting to the ground under the module. Height of these pads (M2) is defined by the half moon and the solder mask. Width of the rectangular portion of the pad (K1) and the inner edge of the pedestal portion are defined by the metal. Height and width of the outer edge of the pedestal portion is defined by the solder mask.

Pad “b” and all other pads are defined by the metal. For information about the paste mask and footprint, see the NEO-M8Q-01A Hardware Integration Manual [1].

## 6 Reliability tests and approvals

### 6.1 Reliability tests

-  NEO-M8Q-01A module is based on AEC-Q100 qualified GNSS chips.
-  For the qualification flow, see the Module qualifications [\[5\]](#).

Tests for product family qualifications are according to ISO 16750 "Road vehicles – environmental conditions and testing for electrical and electronic equipment", and appropriate standards.

### 6.2 Approvals



The NEO-M8Q-01A module complies with the Directives 2011/65/EU and 2015/863/EU of the European Parliament and the Council on the Restriction of Use of certain Hazardous Substances (RoHS).

More information about approvals can be provided upon request.

## 7 Product handling & soldering

### 7.1 Packaging

The NEO-M8Q-01A GNSS module is delivered as hermetically sealed, reeled tapes in order to enable efficient production, production lot set-up and tear-down. For more information, see the u-blox Package Information Guide [3].

#### 7.1.1 Reels

The NEO-M8Q-01A GNSS module is deliverable in quantities of 250 pieces on a reel. The NEO-M8Q-01A receivers are shipped on Reel Type B, as specified in the u-blox Package Information Guide [3].

#### 7.1.2 Tapes

The dimensions and orientations of the tapes for NEO-M8Q-01A modules are specified in Figure 5.

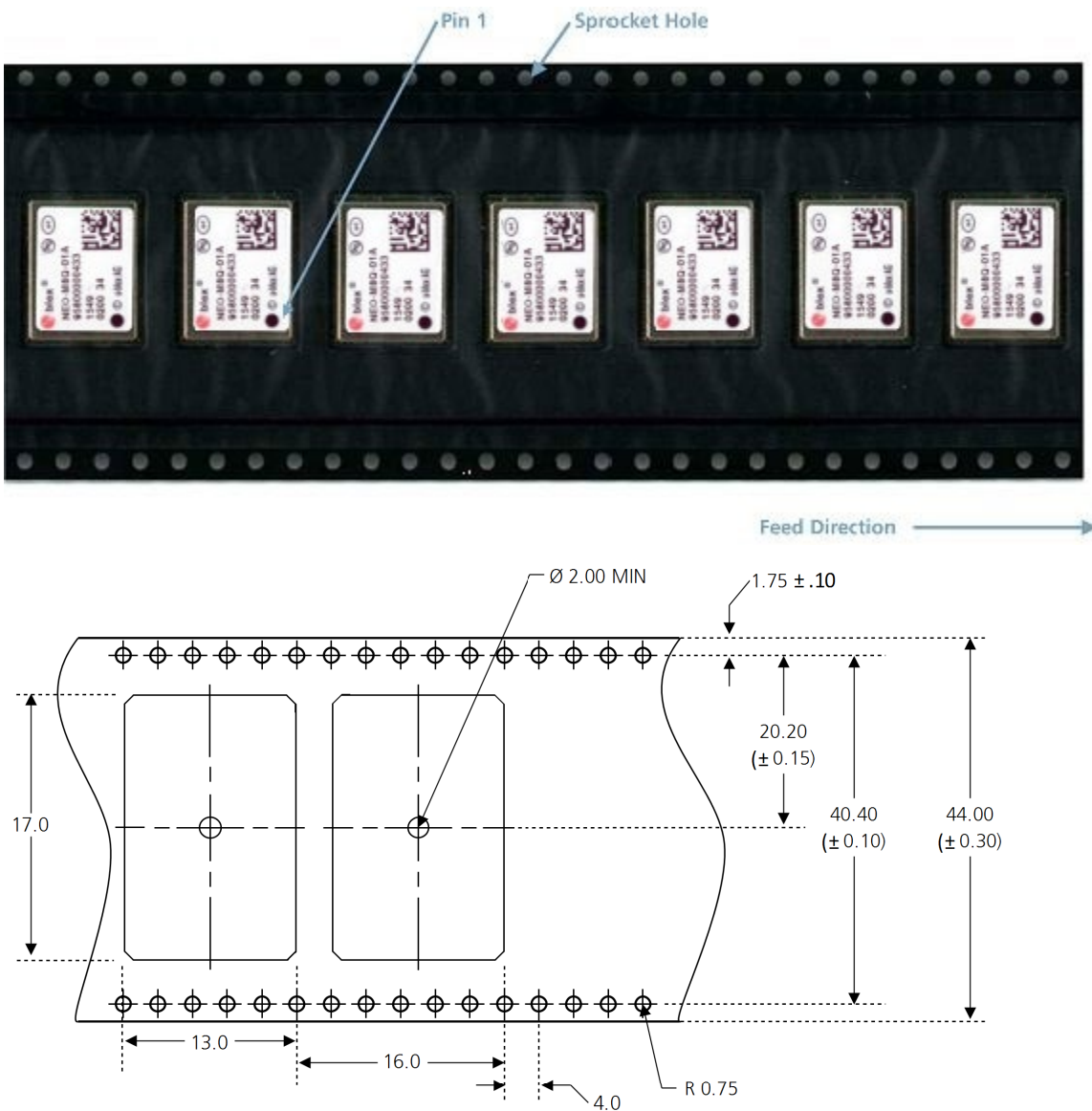

Figure 5: Dimensions and orientation for NEO-M8Q-01A modules on tape

## 7.2 Shipment, storage and handling

For important information regarding shipment, storage and handling, see the u-blox Package Information Guide [3]. The absolute maximum rating of the storage temperature specified in chapter 4.1 applies to the storage of the module both before and after soldering. Required storage conditions for modules in reeled tapes and for naked modules before soldering are described in the u-blox Package Information Guide [3].

### 7.2.1 Moisture Sensitivity Levels

The Moisture Sensitivity Level (MSL) relates to the packaging and handling precautions required. The NEO-M8Q-01A modules are rated at MSL level 3.

For MSL standard see IPC/JEDEC J-STD-020, which can be downloaded from [www.jedec.org](http://www.jedec.org).

For more information regarding MSL, see the u-blox Package Information Guide [3].

### 7.2.2 Reflow soldering

Reflow profiles are to be selected according u-blox recommendations (see the NEO-M8Q-01A Hardware Integration Manual [1]).

### 7.2.3 ESD handling precautions

- NEO-M8Q-01A modules are Electrostatic Sensitive Devices (ESD). Observe precautions for handling! Failure to observe these precautions can result in severe damage to the GNSS receiver!

GNSS receivers are Electrostatic Sensitive Devices (ESD) and require special precautions when handling. Particular care must be exercised when handling patch antennas, due to the risk of electrostatic charges. In addition to standard ESD safety practices, the following measures should be taken into account whenever handling the receiver:

Unless there is a galvanic coupling between the local GND (i.e. the work table) and the PCB GND, then the first point of contact when handling the PCB must always be between the local GND and PCB GND.



Before mounting an antenna patch, connect ground of the device.

When handling the RF pin, do not come into contact with any charged capacitors and be careful when contacting materials that can develop charges (e.g. patch antenna ~10 pF, coax cable ~50-80 pF/m, soldering iron, ...).

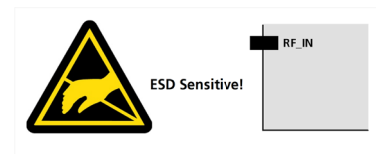

To prevent electrostatic discharge through the RF input, do not touch any exposed antenna area. If there is any risk that such exposed an antenna area is touched in non ESD protected work area, implement proper ESD protection measures in the design.



When soldering RF connectors and patch antennas to the receiver's RF pin, make sure to use an ESD safe soldering iron (tip).





## 8 Default messages

Interface	Settings
UART Output	9600 baud, 8 bits, no parity bit, 1 stop bit Configured to transmit both NMEA and UBX protocols, but only the following NMEA (and no UBX) messages have been activated at start-up: <b>GGA, GLL, GSA, GSV, RMC, VTG, TXT</b>
USB Output	Configured to transmit both NMEA and UBX protocols, but only the following NMEA (and no UBX) messages have been activated at start-up: <b>GGA, GLL, GSA, GSV, RMC, VTG, TXT</b> USB Power Mode: Self-powered
UART Input	9600 baud, 8 bits, no parity bit, 1 stop bit, autobauding disabled Automatically accepts following protocols without need of explicit configuration: UBX, NMEA, RTCM The GNSS receiver supports interleaved UBX and NMEA messages.
USB Input	Automatically accepts following protocols without need of explicit configuration: UBX, NMEA The GPS receiver supports interleaved UBX and NMEA messages. USB Power Mode: Bus-powered
DDC	Fully compatible with the I <sup>2</sup> C industry standard, available for communication with an external host CPU or u-blox cellular modules, operated in slave mode only. Default messages activated. NMEA and UBX are enabled as input messages, only NMEA as output messages. Maximum bit rate 400 kbit/s.
SPI	Allow communication to a host CPU, operated in slave mode only. Default messages activated. SPI is not available in the default configuration.
TIMEPULSE (1 Hz Nav)	1 pulse per second, synchronized at rising edge, pulse length 100 ms.

**Table 13: Default messages**

 Refer to the u-blox 8 / u-blox M8 Receiver Description Including Protocol Specification [\[2\]](#) for information about other settings.

## 9 Labeling and ordering information

### 9.1 Product labeling

The labeling of u-blox M8 GNSS modules includes important product information. The location of the NEO-M8Q-01A product type number is shown in [Figure 6](#).

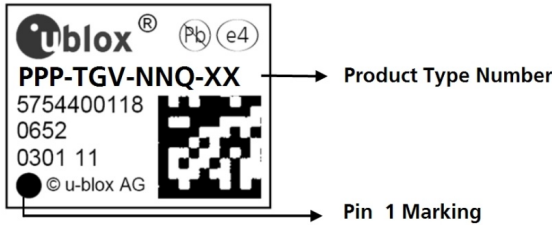

Figure 6: Location of product type number on u-blox NEO-M8Q-01A module label

### 9.2 Explanation of codes

Three different product code formats are used. The **Product Name** is used in documentation such as this data sheet and identifies all u-blox M8 products, independent of packaging and quality grade. The **Ordering Code** includes options and quality, while the **Type Number** includes the hardware and firmware versions. [Table 14](#) shows the structure of these three different formats.

Format	Structure
Product Name	PPP-TGV
Ordering Code	PPP-TGV-NNQ
Type Number	PPP-TGV-NNQ-XX

Table 14: Product code formats

The parts of the product code are explained in [Table 15](#).

Code	Meaning	Example
PPP	Product Family	NEO
TG	Platform	M8 = u-blox M8
V	Variant	Function set (A-Z), T = Timing, R = DR, etc.
NNQ	Option and Quality Grade	Describes standardized functional element and quality grade NN: Option [00 ...99] Q: A = Automotive
XX	Product Detail	Describes product details or options such as hardware and software revision, cable length, etc.

Table 15: Part identification code

### 9.3 Ordering codes

Ordering No.	Product
NEO-M8Q-01A	u-blox M8 Concurrent GNSS LCC Module, TCXO, ROM, 12.2x16 mm, 250 pcs/reel, Automotive Grade

Table 16: Product ordering codes for the Automotive grade module

Product changes affecting form, fit or function are documented by u-blox. For a list of Product Change Notifications (PCNs), see our website.

# Appendix

## A Glossary

Abbreviation	Definition
AEC	Automotive Electronics Council
BBR	Battery Backed RAM
DDC	Display Data Channel
EGNOS	European Geostationary Navigation Overlay Service
ESD	Electrostatic Sensitive Device*
FOC	Full Operational Capability
GAGAN	GPS Aided GEO Augmented Navigation
GLONASS	GLObal Navigation Satellite System (Russian)
GNSS	Global Navigation Satellite System
GPIO	General Purpose Input/Output
GPS	Global Positioning System
IMES	Indoor MESSaging System
I2C	Inter-Integrated Circuit
IEC	International Electrotechnical Commission
ISO	International Organization for Standardization
LCC	Leadless Chip Carrier
LCS	LoCation Services (protocol)
LNA	Low Noise Amplifier
MSAS	MTSAT Satellite Augmentation System
MSL	Moisture Sensitivity Level
NMEA	National Marine Electronics Association
PPP	Point-to-Point Protocol* / Precise Point Positioning*
PCB	Printed Circuit Board
PCN	Product Change Notification
PPS	Pulse Per Second
QZSS	Quasi-Zenith Satellite System
RLM	Return Link Message
RRLP	Radio Resource LCS Protocol
RTC	Real Time Clock
RTCM	Radio Technical Commission for Maritime Services
SAW	Surface Acoustic Wave
SBAS	Satellite-Based Augmentation System
SCL	Serial Clock
SMD	Solder Mask Defined
SUPL	Secure User Plane Location
TCXO	Temperature-Compensated Crystal Oscillator
TTF	Time-To-First-Fix
UART	Universal Asynchronous Receiver/Transmitter
UTC	Coordinated Universal Time
WAAS	Wide Area Augmentation System

**Table 17: Explanation of the abbreviations and terms used**

## Related documents

- [1] NEO-M8Q-01A Hardware Integration Manual, Doc. No. [UBX-15025981](#)
- [2] u-blox 8 / u-blox M8 Receiver Description Including Protocol Specification (Public version), Doc. No. [UBX-13003221](#)
- [3] u-blox Package Information Guide, Doc. No. [UBX-14001652](#)
- [4] Power Management Application Note, Doc. No. [UBX-13005162](#)
- [5] Module qualifications, automotive grade, Confidential, Doc. No. [UBX-15025312](#)
- [6] Radio Resource LCS Protocol (RRLP), (3GPP TS 44.031 version 11.0.0 Release 11)

 For regular updates to u-blox documentation and to receive product change notifications, register on our homepage ([www.u-blox.com](http://www.u-blox.com)).

## Revision history

Revision	Date	Name	Comments
R01	12-Jul-2016	jfur	Objective Specification
R02	08-Sep-2016	jfur	Advance Information
R03	16-Jan-2017	jesk	Early Production Information. Updated section 1.5.4 with QZSS clarification and Galileo Initial Services, corrected RRLP specification name in section 1.8, minor modifications in Table 6 (SCL/SPI CLK: input only) and Table 9 (changed operating temperature to ambient temperature and updated SW backup current value), updated Figure 4 and section 6.2 with additional information, added storage temperature related statement in section 7.2, updated section 9.3 (added product grade information).
R04	05-Dec-2017	rmak	Production Information
R05	27-May-2019	mbab, jesk	Updated sections 1.6.3, (AssistNow Autonomous), 4.1 (Absolute maximum rating) and 6.2 (RoHS statement), added PIO numbers in 2.1, added antenna supervisor and supply as supported feature in 1.2

# Contact

For complete contact information, visit us at [www.u-blox.com](http://www.u-blox.com).

## u-blox Offices

### North, Central and South America

#### u-blox America, Inc.

Phone: +1 703 483 3180  
E-mail: [info\\_us@u-blox.com](mailto:info_us@u-blox.com)

#### Regional Office West Coast:

Phone: +1 408 573 3640  
E-mail: [info\\_us@u-blox.com](mailto:info_us@u-blox.com)

#### Technical Support:

Phone: +1 703 483 3185  
E-mail: [support@u-blox.com](mailto:support@u-blox.com)

### Headquarters

#### Europe, Middle East, Africa

#### u-blox AG

Phone: +41 44 722 74 44  
E-mail: [info@u-blox.com](mailto:info@u-blox.com)  
Support: [support@u-blox.com](mailto:support@u-blox.com)

### Asia, Australia, Pacific

#### u-blox Singapore Pte. Ltd.

Phone: +65 6734 3811  
E-mail: [info\\_ap@u-blox.com](mailto:info_ap@u-blox.com)  
Support: [support\\_ap@u-blox.com](mailto:support_ap@u-blox.com)

#### Regional Office Australia:

Phone: +61 2 8448 2016  
E-mail: [info\\_anz@u-blox.com](mailto:info_anz@u-blox.com)  
Support: [support\\_ap@u-blox.com](mailto:support_ap@u-blox.com)

#### Regional Office China (Beijing):

Phone: +86 10 68 133 545  
E-mail: [info\\_cn@u-blox.com](mailto:info_cn@u-blox.com)  
Support: [support\\_cn@u-blox.com](mailto:support_cn@u-blox.com)

#### Regional Office China (Chongqing):

Phone: +86 23 6815 1588  
E-mail: [info\\_cn@u-blox.com](mailto:info_cn@u-blox.com)  
Support: [support\\_cn@u-blox.com](mailto:support_cn@u-blox.com)

#### Regional Office China (Shanghai):

Phone: +86 21 6090 4832  
E-mail: [info\\_cn@u-blox.com](mailto:info_cn@u-blox.com)  
Support: [support\\_cn@u-blox.com](mailto:support_cn@u-blox.com)

#### Regional Office China (Shenzhen):

Phone: +86 755 8627 1083  
E-mail: [info\\_cn@u-blox.com](mailto:info_cn@u-blox.com)  
Support: [support\\_cn@u-blox.com](mailto:support_cn@u-blox.com)

#### Regional Office India:

Phone: +91 80 405 092 00  
E-mail: [info\\_in@u-blox.com](mailto:info_in@u-blox.com)  
Support: [support\\_in@u-blox.com](mailto:support_in@u-blox.com)

#### Regional Office Japan (Osaka):

Phone: +81 6 6941 3660  
E-mail: [info\\_jp@u-blox.com](mailto:info_jp@u-blox.com)  
Support: [support\\_jp@u-blox.com](mailto:support_jp@u-blox.com)

#### Regional Office Japan (Tokyo):

Phone: +81 3 5775 3850  
E-mail: [info\\_jp@u-blox.com](mailto:info_jp@u-blox.com)  
Support: [support\\_jp@u-blox.com](mailto:support_jp@u-blox.com)

#### Regional Office Korea:

Phone: +82 2 542 0861  
E-mail: [info\\_kr@u-blox.com](mailto:info_kr@u-blox.com)  
Support: [support\\_kr@u-blox.com](mailto:support_kr@u-blox.com)

#### Regional Office Taiwan:

Phone: +886 2 2657 1090  
E-mail: [info\\_tw@u-blox.com](mailto:info_tw@u-blox.com)  
Support: [support\\_tw@u-blox.com](mailto:support_tw@u-blox.com)