

REV.	ECN NO.	DATE	SIGN	DESCRIPTION
B	LE3-960040	2009/06/22	Prune	Change The Note And 螺牙

ALTW  
DCC. DEPT.  
CONFIDENTIAL  
2012-06-13  
ISSUED

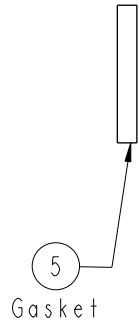

With Liquid Glue

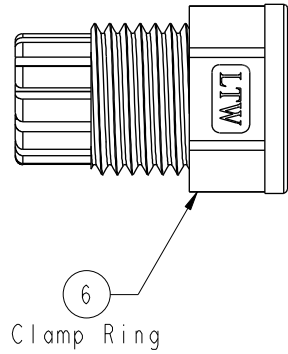
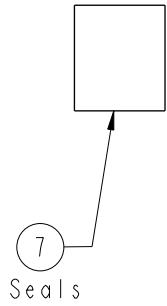
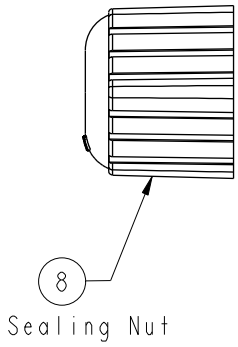
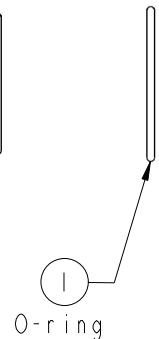
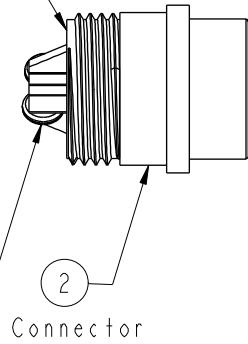
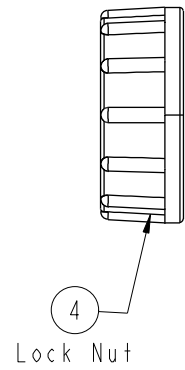

- Note:
- \*  $\varnothing$  Important Dimension To Check.
  - \* Waterproof Rate: IP67
  - \* Housing: Nylon+GF
  - \* Pin: Copper Alloy, Gold Plated
  - \* Liquid Glue: Clear
  - \* Screw: Stainless Steel
  - \* Ring: Black, EPDM
  - \* Nut: Black, Nylon+GF
  - \* Gasket: Black, Silicone
  - \* Clamping Ring: Black, Nylon
  - \* Seals: Black, EPDM
  - \* Sealing Nut: Black, Nylon
  - \* PE Bag  $\text{\textcircled{9}}$  \* PE Bag: 90\*85mm
  - \* Seal For Cable OD:  $\varnothing$  5.5mm~10.8mm
  - \* One Set Unassembled In One PE Bag
  - $\triangle$  \* Application AWG: 14~16AWG

ALTW  
CONFIDENTIAL  
2012-05-03  
R&D DEPT.

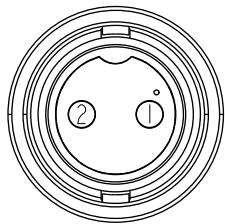
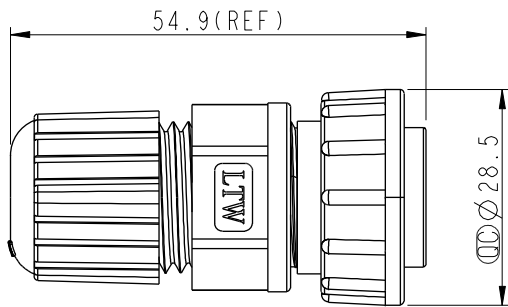

PE Bag  $\text{\textcircled{9}}$

UNIT: mm		
TOLERANCE	.X $\pm 0.25$	
	.XX $\pm 0.1$	
	.XXX $\pm 0.05$	
ANGLES	$\pm 1^\circ$	

TITLE Large Assy Lock 2Pin F Conn M Pin			
SCALE 1:1	SIZE A4	SHEET 1 OF 1	
REV. B	WC-REV. A.2	$\varnothing$ : Inspection item	

**Amphenol LTW**  
安費諾亮泰企業股份有限公司

ITEM NO. DC-02BFMB-LL7001	DRAWN BY SamChang	DATE 2012-05-03
DWG NO. DC-02BFMB-LL7001	CHECKED BY Jeffrey	DATE 2012-06-13
CUSTOMER ALTW	APPROVED BY Lion	DATE 2012-06-13

THIS DOCUMENT IS SUBJECT TO CHANGE WITHOUT NOTICE. IT IS CONFIDENTIAL AND A PROPERTY OF AMPHENOL LTW. DISCLOSURE TO THIRD PARTY HAS TO BE AUTHORIZED BY AMPHENOL LTW.