

SPDT Default On High Isolation CATV Switch 5 – 3000 MHz

Rev. V3

Features

- 75 Ω Terminations RF1 / RF2
- Positive Voltage Control
- High Isolation: 90 dB @ 216 MHz
- Low Insertion Loss: 1.4 dB @ 2200 MHz
- Lead-Free 3 mm 16-Lead PQFN Package
- Halogen-Free “Green” Mold Compound
- RoHS* Compliant and 260°C Reflow Compatible

Description

The MASW-009101 is a single pole double throw (SPDT) switch in a lead-free 3 mm 16-lead PQFN package. It meets FCC 15.115 specification of 80 dB isolation between RF1 and RF2 at 216 MHz during powered and un-powered states. The default on un-powered state provides a low insertion loss path from RFC to RF1 while maintaining high isolation between RF2 and RFC/RF1.

This device is ideally suited for applications where low control voltage, high isolation, small size and low cost are required.

Typical applications are to replace mechanical relays in CATV and satellite systems. This part can be used in all 75 Ω systems operating up to 3 GHz.

The MASW-009101 is fabricated using a GaAs pHEMT process. The process features full passivation for performance and reliability.

Ordering Information ^{1,2}

Part Number	Package
MASW-009101-TR3000	3000 piece reel
MASW-009101-001SMB	Sample Board

1. Reference Application Note M513 for reel size information.
2. All sample boards include 5 loose parts.

Functional Schematic**

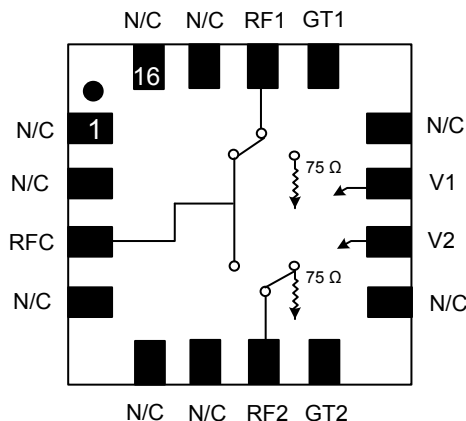

** Default On path shown

Pin Configuration ³

Pin No.	Pin Name	Description
1	N/C	No Connection
2	N/C	No Connection
3	RFC	RF Common Port
4	N/C	No Connection
5	N/C	No Connection
6	N/C	No Connection
7	RF2	RF Port 2
8	GT2	RF Termination
9	N/C	No Connection
10	V2	Control Voltage 2
11	V1	Control Voltage 1
12	N/C	No Connection
13	GT1	RF Termination
14	RF1	RF Port 1
15	N/C	No Connection
16	N/C	No Connection
17	PAD ³	RF and DC Ground

3. The exposed pad centered on the package bottom must be connected to RF and DC ground.

* Restrictions on Hazardous Substances, European Union Directive 2002/95/EC.

SPDT Default On High Isolation CATV Switch 5 – 3000 MHz

Rev. V3

Electrical Specifications: $T_A = 25^\circ\text{C}$, $V_C = 0\text{ V} / 3\text{ V}$, $Z_0 = 75\ \Omega^4$

Parameter	Test Conditions	Units	Min.	Typ.	Max.
Insertion Loss RF1 to RFC	50 MHz 220 MHz 1000 MHz 2200 MHz	dB	—	0.5 0.6 0.8 1.0	1.4
Insertion Loss RF2 to RFC	50 MHz 220 MHz 1000 MHz 2200 MHz	dB	—	0.8 0.9 1.2 1.4	1.9
Isolation RFC-RF1/RF2	50 MHz 220 MHz 1000 MHz 2200 MHz	dB	52 47	80 70 55 50	—
Isolation RF1-RF2	50 MHz 220 MHz 1000 MHz 2200 MHz	dB	80 60 47	95 95 70 50	—
Return Loss	50 MHz 220 MHz 1000 MHz 2200 MHz	dB	—	25 20 15 13	—
Input P1dB (RF1/RF2)	1000 MHz	dBm	—	28/18	—
IIP3 (RF1/RF2)	2 tone, 5 dBm/tone, 6MHz spacing, 1000 MHz	dBm	—	40/37	—
IIP2 (RF1/RF2)	2 tone, 5 dBm/tone, 6MHz spacing, 1000 MHz	dBm	—	58/53	—
CSO (RF1/RF2)	132 channels, 18 dBmV / channel in	dBc	—	-80/-70	—
CTB (RF1/RF2)	132 channels, 18 dBmV / channel in	dBc	—	-85/-85	—
Trise, Tfall	10% to 90% RF, 90% to 10% RF	ns	—	16	—
Ton, Toff	50% control to 90% RF, 50% control to 10% RF	ns	—	120	—
Transients	In Band	mV	—	80	—
Control Current	$ V_C = 3.0\text{ V}$	μA	—	500	600

Electrical Specifications: $T_A = 25^\circ\text{C}$, $Z_0 = 75\ \Omega^4$, Unpowered Operation

Parameter	Test Conditions	Units	Min.	Typ.	Max.
Insertion Loss RF1 to RFC	2200 MHz	dB	—	—	1.4
Isolation RF1-RF2	50 MHz 220 MHz 1000 MHz 2200 MHz	dB	60 47	90 90 70 50	—
CSO / CTB	132 channels, 18 dBmV / channel in	dBc	—	-80/-80	—

4. External 0.1 μF DC blocking capacitors are required on all RF In/Out and RF ground ports. See Application Schematic.

SPDT Default On High Isolation CATV Switch 5 – 3000 MHz

Rev. V3

Truth Table ⁵

V1	V2	RFC - RF1	RFC - RF2
0	0	On	Off
1	0	On	Off
0	1	Off	On

5. Powered Operation: 1 = +3 to +5 V, 0 = 0 ± 0.2 V.
Unpowered Operation: V1 = V2 = 0 V, |V1-V2| ≤ 0.1 V.

Application Schematic

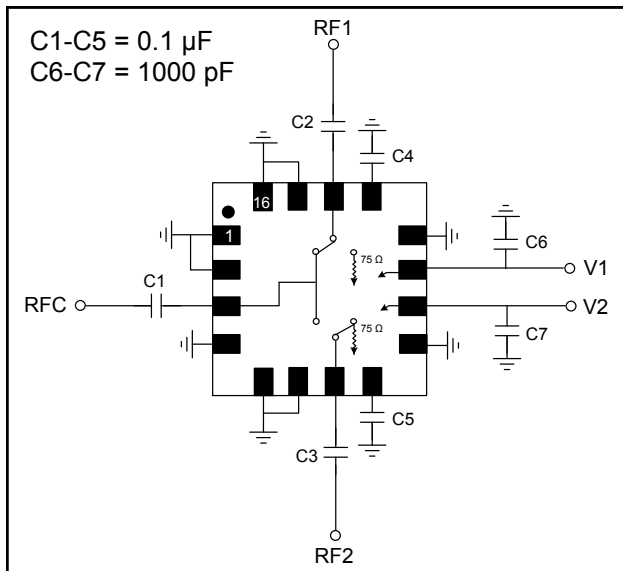

Recommended PCB

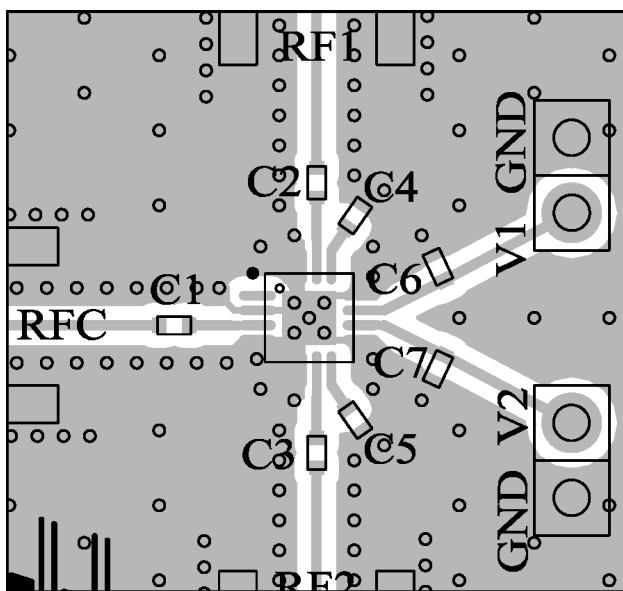

Absolute Maximum Ratings ^{6,7}

Parameter	Absolute Maximum
Input Power (5 - 3000 MHz, 3 V Control)	+29 dBm
Operating Voltage	+8.5 volts
Operating Temperature	-40°C to +85°C
Storage Temperature	-65°C to +150°C

- Exceeding any one or combination of these limits may cause permanent damage.
- M/A-COM Technology Solutions does not recommend sustained operation near these survivability limits.

Off-Chip Component Values

Component	Value	Package
C1-C5	0.1 μF	0402
C6-C7	1000 pF	0402

Handling Procedures

Please observe the following precautions to avoid damage:

Static Sensitivity

Gallium Arsenide Integrated Circuits are sensitive to electrostatic discharge (ESD) and can be damaged by static electricity. Proper ESD control techniques should be used when handling these devices.

Typical Performance Curves: Powered State

Insertion Loss, RFC to RF1

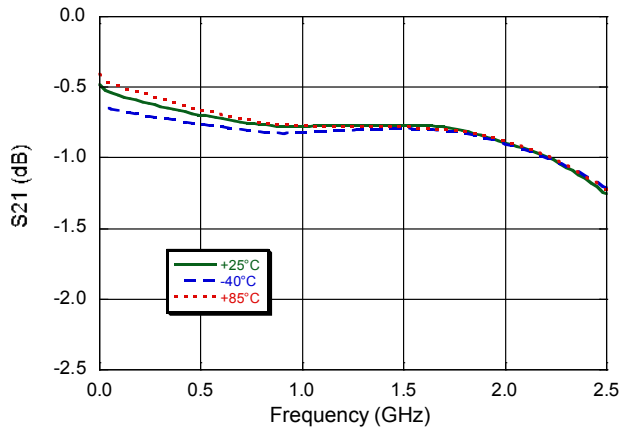

Insertion Loss, RFC to RF2

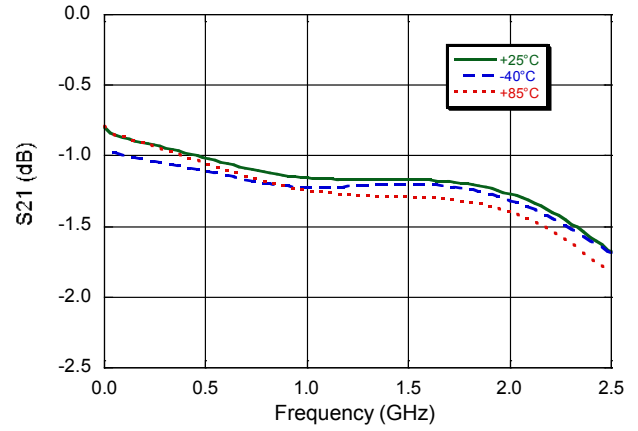

Isolation, RFC to RF1

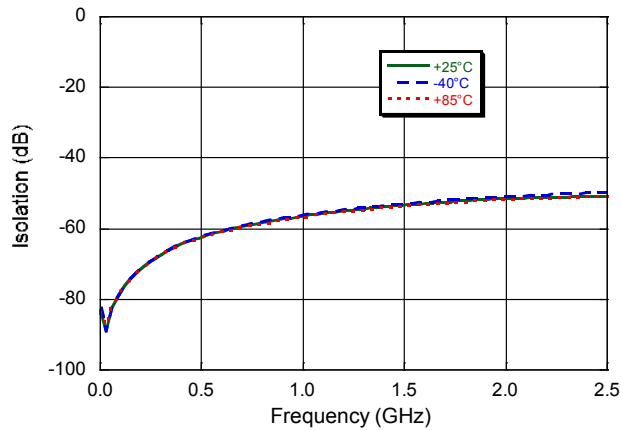

Isolation, RFC to RF2

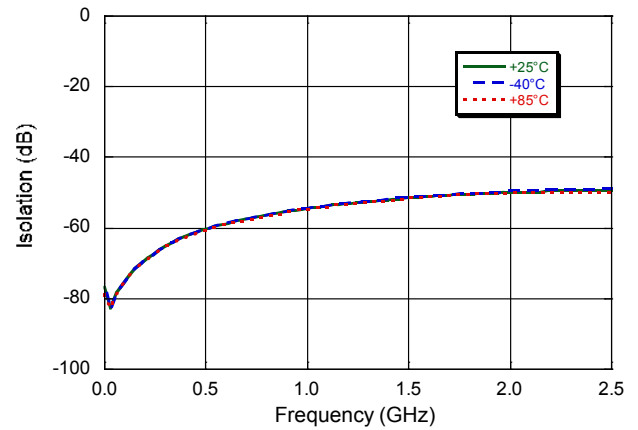

SPDT Default On High Isolation CATV Switch 5 – 3000 MHz

Rev. V3

Typical Performance Curves: Powered State

Isolation, RF1 to RF2 (RFC to RF1 State)

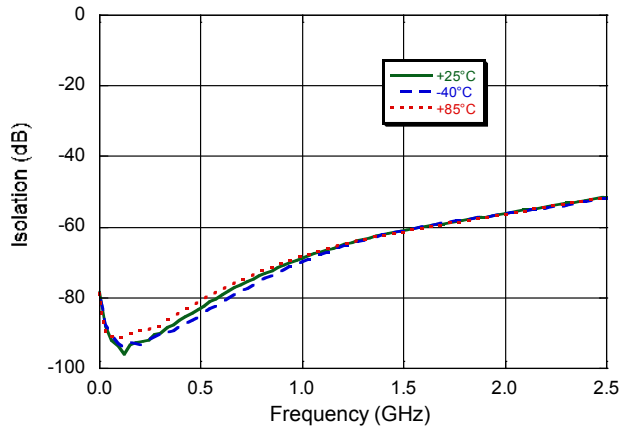

Isolation, RF1 to RF2 (RFC to RF2 State)

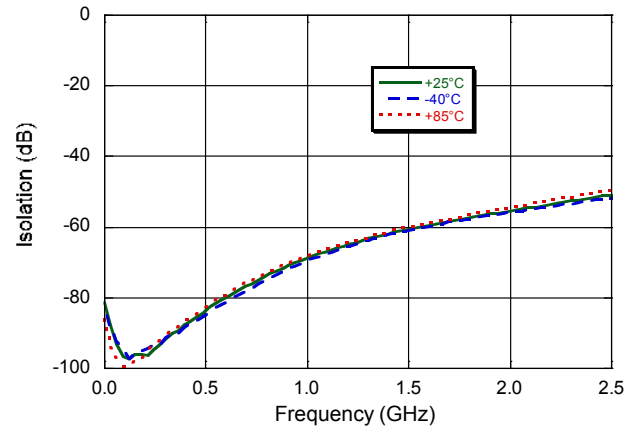

Input Return Loss, RFC

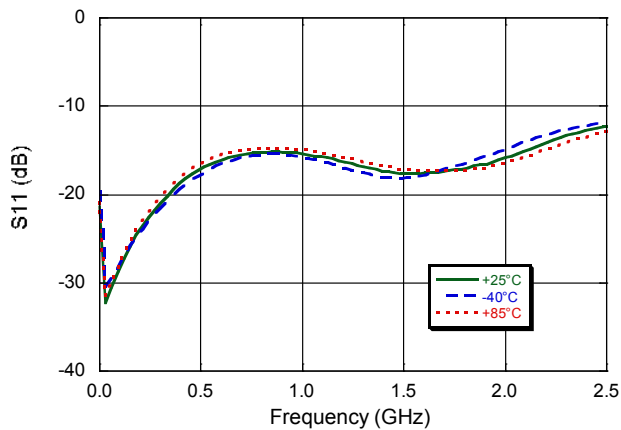

Output Return Loss, RF1/RF2

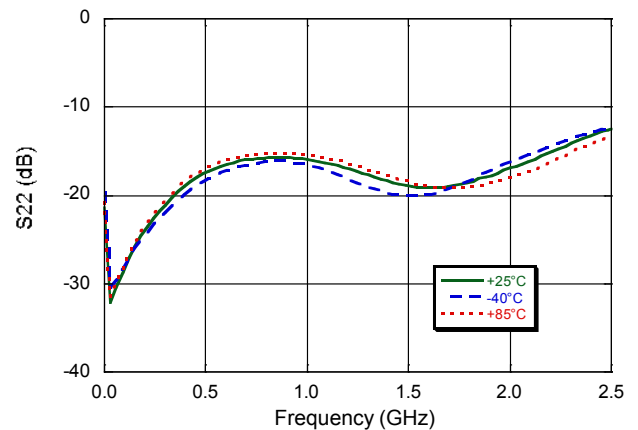

SPDT Default On High Isolation CATV Switch 5 – 3000 MHz

Rev. V3

Typical Performance Curves: Unpowered State

Insertion Loss, RFC to RF1 (unpowered state)

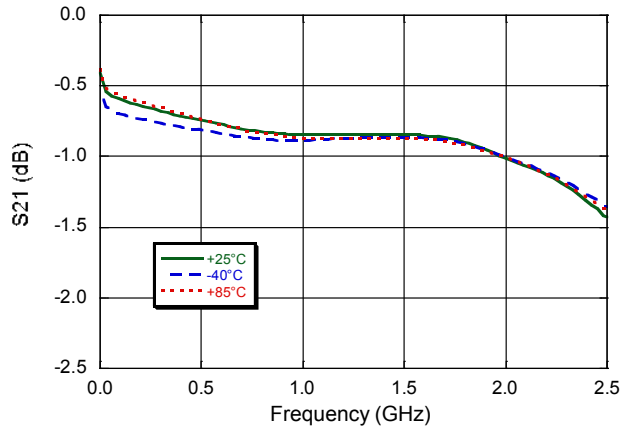

Isolation, RF1 to RF2 (RFC to RF1 unpowered state)

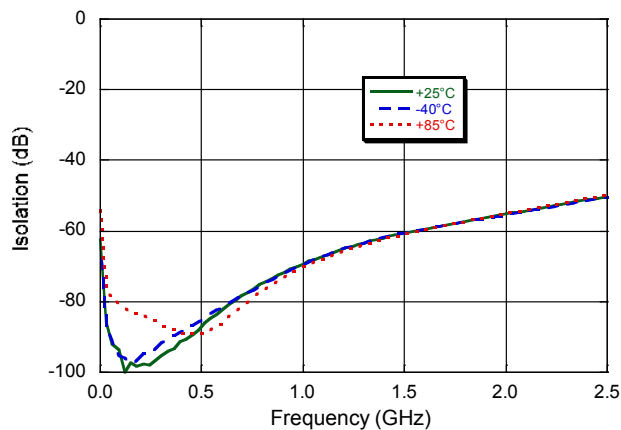

Isolation, RFC to RF2 (unpowered state)

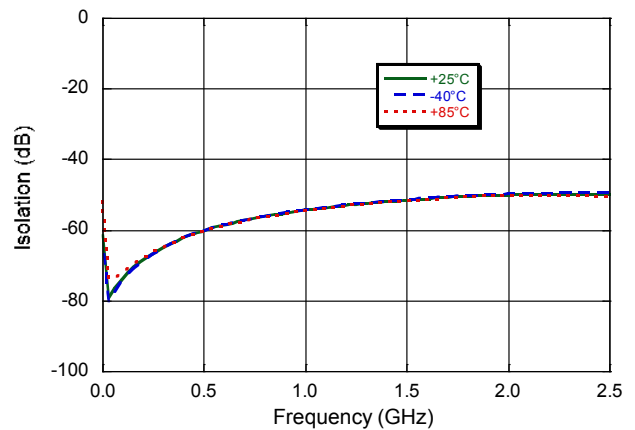

Output Return Loss, RF1/RF2 (unpowered state)

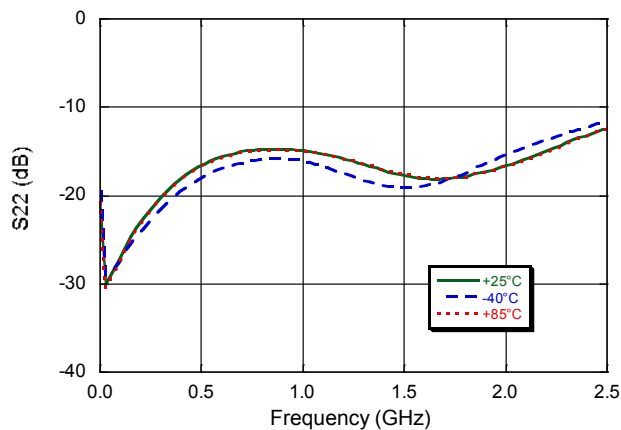

Input Return Loss, RFC (unpowered state)

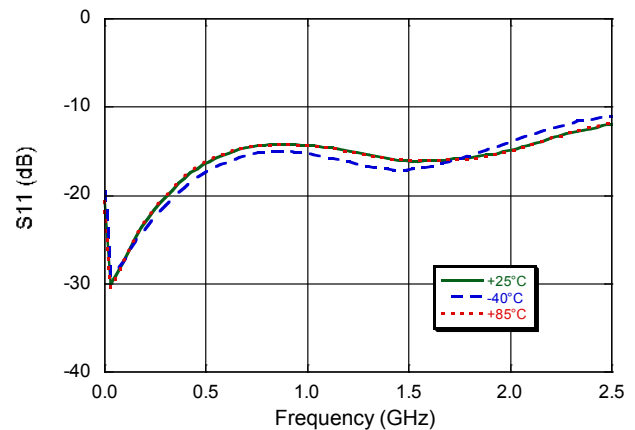

SPDT Default On High Isolation CATV Switch 5 – 3000 MHz

Rev. V3

Lead-Free 3 mm 16-Lead PQFN[†]

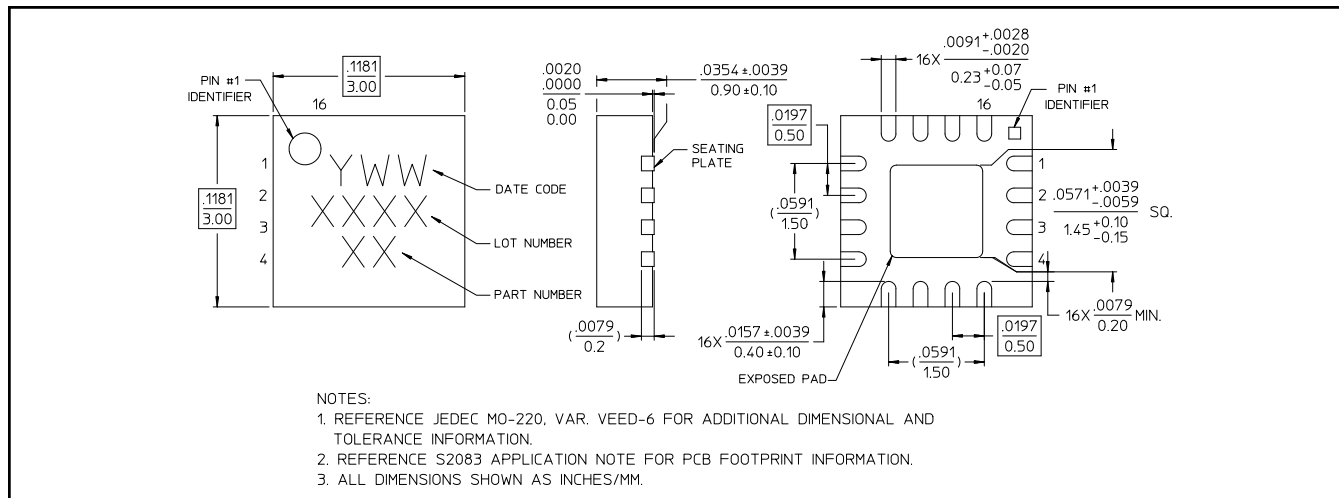

[†] Reference Application Note S2083 for lead-free solder reflow recommendations.
Meets JEDEC moisture sensitivity level 1 requirements.
Plating is 100% tin over copper.

M/A-COM Technology Solutions Inc. All rights reserved.

Information in this document is provided in connection with M/A-COM Technology Solutions Inc ("MACOM") products. These materials are provided by MACOM as a service to its customers and may be used for informational purposes only. Except as provided in MACOM's Terms and Conditions of Sale for such products or in any separate agreement related to this document, MACOM assumes no liability whatsoever. MACOM assumes no responsibility for errors or omissions in these materials. MACOM may make changes to specifications and product descriptions at any time, without notice. MACOM makes no commitment to update the information and shall have no responsibility whatsoever for conflicts or incompatibilities arising from future changes to its specifications and product descriptions. No license, express or implied, by estoppel or otherwise, to any intellectual property rights is granted by this document.

THESE MATERIALS ARE PROVIDED "AS IS" WITHOUT WARRANTY OF ANY KIND, EITHER EXPRESS OR IMPLIED, RELATING TO SALE AND/OR USE OF MACOM PRODUCTS INCLUDING LIABILITY OR WARRANTIES RELATING TO FITNESS FOR A PARTICULAR PURPOSE, CONSEQUENTIAL OR INCIDENTAL DAMAGES, MERCHANTABILITY, OR INFRINGEMENT OF ANY PATENT, COPYRIGHT OR OTHER INTELLECTUAL PROPERTY RIGHT. MACOM FURTHER DOES NOT WARRANT THE ACCURACY OR COMPLETENESS OF THE INFORMATION, TEXT, GRAPHICS OR OTHER ITEMS CONTAINED WITHIN THESE MATERIALS. MACOM SHALL NOT BE LIABLE FOR ANY SPECIAL, INDIRECT, INCIDENTAL, OR CONSEQUENTIAL DAMAGES, INCLUDING WITHOUT LIMITATION, LOST REVENUES OR LOST PROFITS, WHICH MAY RESULT FROM THE USE OF THESE MATERIALS.

MACOM products are not intended for use in medical, lifesaving or life sustaining applications. MACOM customers using or selling MACOM products for use in such applications do so at their own risk and agree to fully indemnify MACOM for any damages resulting from such improper use or sale.