

Overview

KEMET's Pyroelectric Infrared Sensors use the pyroelectric effect of ceramic by absorbing infrared rays emitted from the human body. This detects the natural infrared signature produced by humans. Also, it can detect infrared rays without using lenses.

Due to the absence of a lens, KEMET's Pyro Sensor is low profile, as it does not protrude, which makes it ideal for gathering visual requirements. With KEMET's proprietary piezoelectric ceramic material and element structure of the Pyroelectric Infrared Sensor, you can also detect humans through glass or resin. This allows more freedom in the design of the outer appearance of the end product.

Applications

Typical applications include human presence detection sensing for energy saving functions in:

- Contact less switching
- Office automation equipment
- Home appliances
- Lighting
- Display products
- Air-conditioners
- TV
- PC monitors
- Rice cookers
- Smart toilets

Benefits

- Reflow capable SMD configuration
- Lens not required
- Wide view angle up to ± 60 degrees
- Detection possible through glass or resin
- Low power consumption, down in the μA range
- Excellent radio wave performance in high-frequency band
- Compact and low profile (5.0 x 4.8 x 1.7mm)

Front

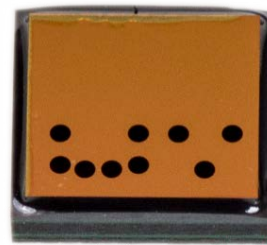

Back

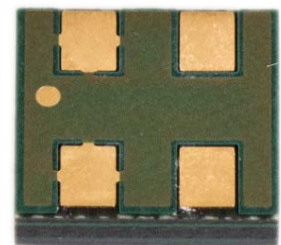

Ordering Information

PL-	N	823-	01
Series	Lens Type	Sensor Type	Serial Number
PL	N = No lens	823	01

Performance Characteristics

Item	Performance Characteristics
Operating temperature	-40°C to +70°C
Storage temperature	-40°C to +85°C

Measuring Method

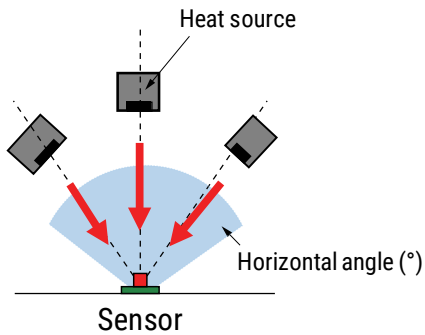

Detected Distance (m)

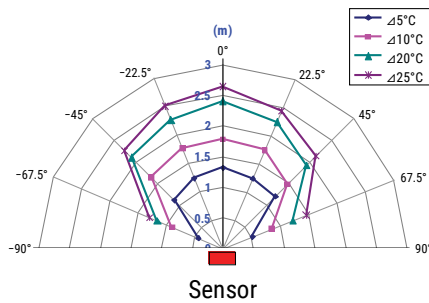

ΔT (°C) = Difference between room temperature and heat source temperature

Performance Characteristics (cont.)

Detecting Performance with Different Materials

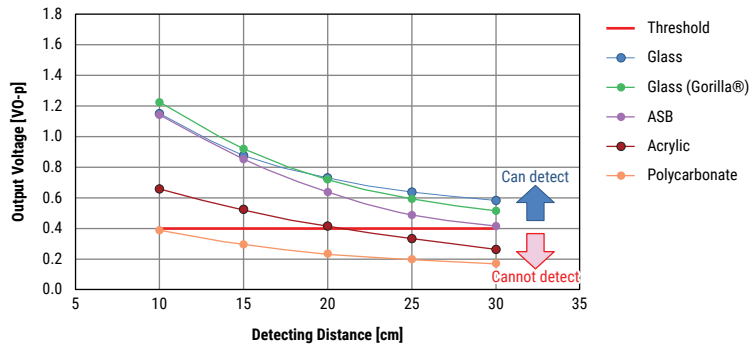

Measuring conditions: Transfer velocity - 1 m/s
 Heat source size - 170×70 mm (relative to hand)
 Temperature difference - $\Delta 10^{\circ}\text{C}$
 Each material thickness - 1 mm (clear color)

Dimensions in mm

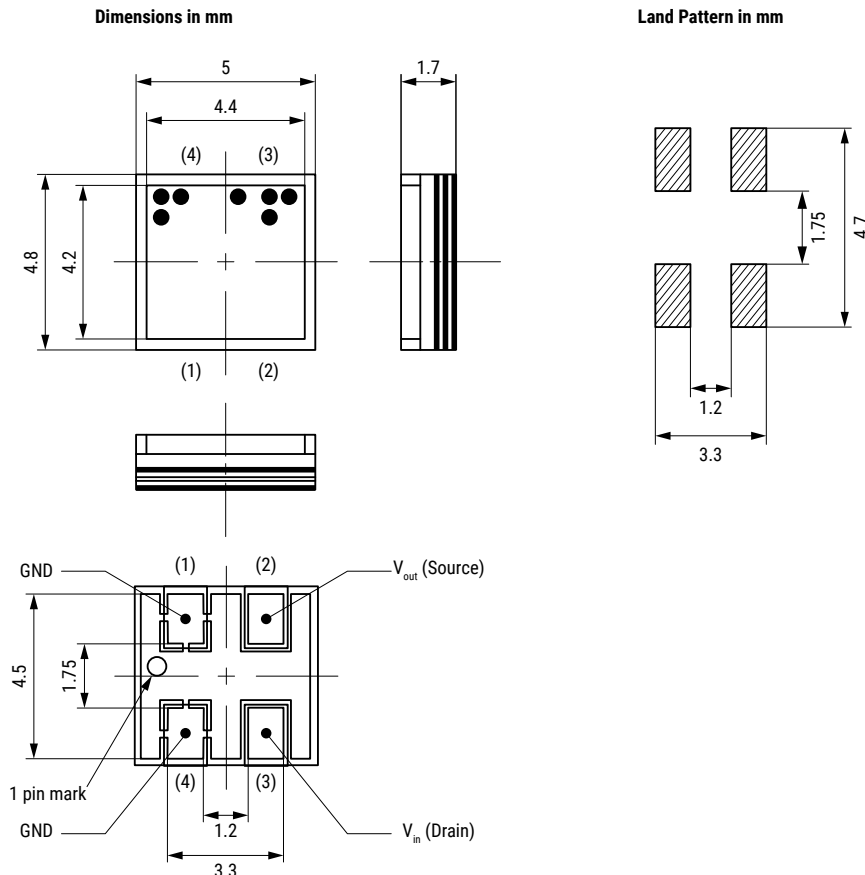

Environmental Compliance

All KEMET Pyroelectric Infrared Sensors are RoHS and REACH Compliant.

Article 33(1) of the REACH Regulation states that manufacturers and importers of articles (products) are required to notify their customers of the presence of any Substances of Very High Concern (SVHC) in their products exceeding 0.1% by weight and provide instructions on safe use of the product.

KEMET Corporation reports regarding the Article 33(1) of REACH Regulation as follows:

1. Applicable Product: Pyroelectric Infrared Sensors (PL series)

2. Report for the content of REACH SVHC list:

The product(s) above contains a substance by more than 0.1wt% per product weight that was published in the 8th update of the REACH SVHC substances (December 19, 2012).

3. Regarding the safety of the pyroelectric infrared sensors (Piezoceramic products):

The Piezoceramic that is used in this product becomes ceramic by sintering powder containing PZT as the main ingredient. It is chemically stable, with minimum risks toward the human body or environment within the intended use of the product. Please note that risks could occur in the case of inhalation or accidental oral uptake of powder ceramics.

4. Technical product information on the multilayer piezoelectric actuators (Piezoceramic products):

The manufacturing technique of the “piezoceramic products” whose main ingredient is Lead Titanium Zirconium Oxide (PZT) has been established, and there is no alternative material that can exhibit superior performance than PZT at this moment. Please note that the piezoceramic is listed as an exempt on RoHS (2011/65/EU) AnnexIII (7c.1).

5. The responsibility of piezoceramic manufacturers:

Piezoceramic manufacturers report information regarding PZT containment in their products to the customers to obey the article 33 of the REACH regulation

Table 1 – Ratings & Part Number Reference

Part Number	Supply Voltage (VDC)	Minimum Output Voltage ¹ (mVp-p)	Source Voltage ² (V)	Maximum Noise ³ (mVp-p)	Maximum Warm up Time ⁴ (seconds)	Field of View (°)	Weight (g)
PL-N823-01	2.0 ~ 15.0	600	0.3 ~ 0.9	200	30	Horizontal: ±60deg Vertical : ±60deg	0.1

¹ Difference of temperature with ambient temperature and heat source: 70°C, aperture diameter: Φ10, 1 Hz and AMP: 26 dB

² Vd = 5 V and Rs = 47 kΩ

³ AMP = 72 dB and Rs = 47 kΩ

⁴ The warm up time is defined by the time needed for the source voltage to reach a rated value after the sensor’s power supply has been turned on.

Applications

Non-contact Switch

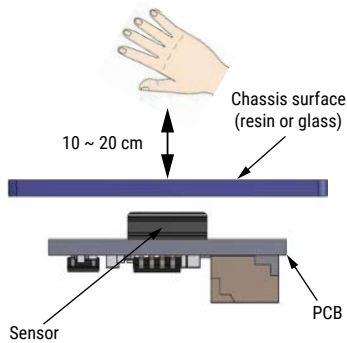

Detecting distance will vary by the chassis material used.

Common Applications

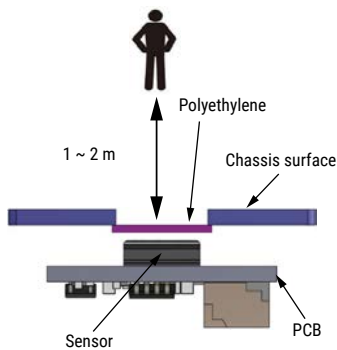

Detecting distance increased to a few meters by using a polyethylene plate.

Part Schematic

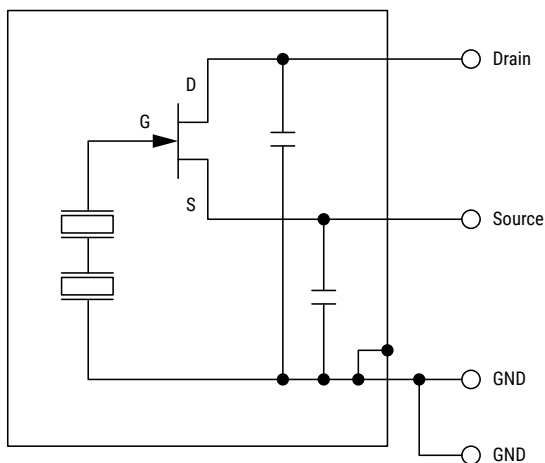

Tape & Reel Packaging Information

Series	Packaging Type	Pieces per Reel
PL	Tape & Reel	2,000

Taping Specifications

Dimensions of indented square hole plastic tape

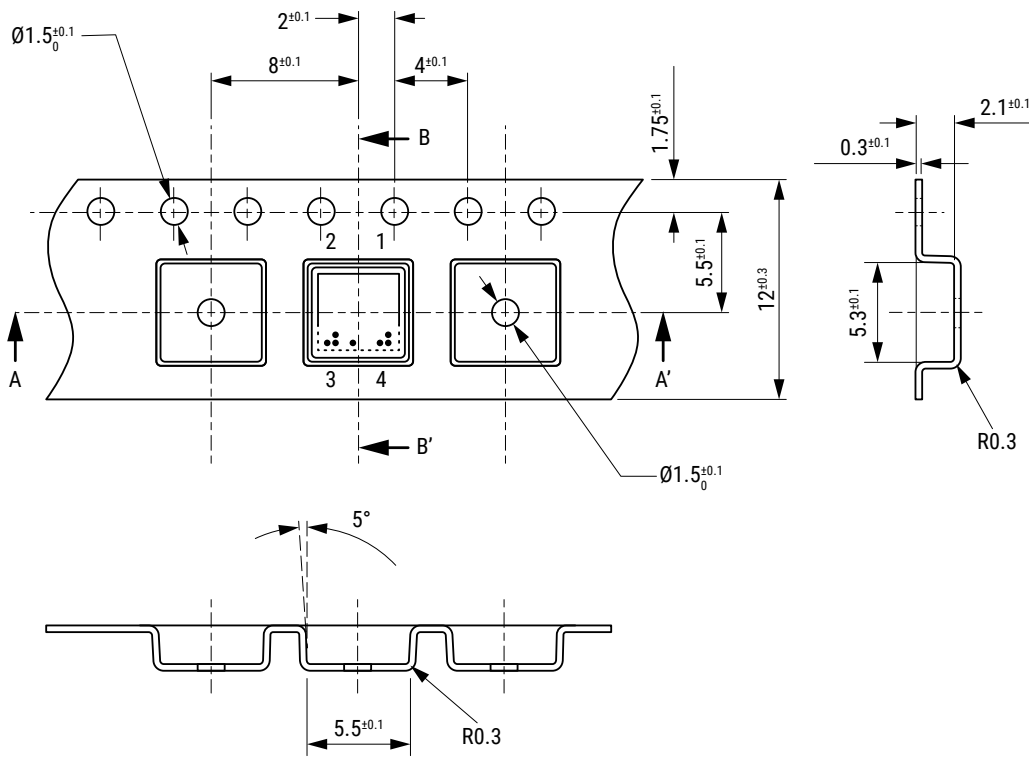

Reel Specifications

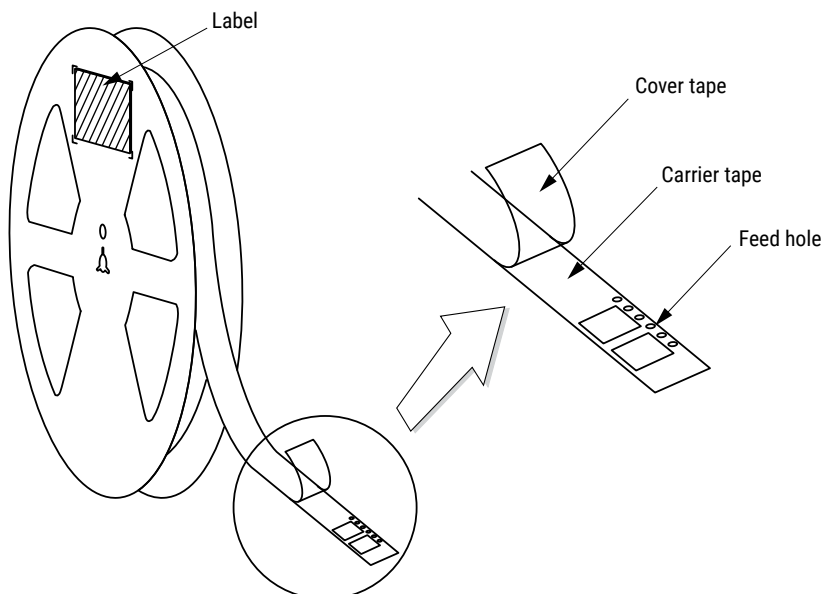

Handling Precautions

Pyroelectric Infrared Sensors should be kept away from wind, directly or indirectly, from sunlight or headlight of car and avoid exposing to strong vibration and strong shock. Do not use in water, alcohol ETA, corrosive gas or under sea breeze. Do not drop or apply any other mechanical stress.

Pyroelectric Infrared Sensors should be stored in normal working environments. Solderability will be degraded by exposure to high temperatures, high humidity, corrosive atmospheres, and long term storage.

KEMET recommends that maximum storage temperature not exceed 25°C and maximum storage humidity not exceed 50% relative humidity. Atmospheres should be free of chlorine and sulfur bearing compounds. Temperature fluctuations should be minimized to avoid condensation on the parts. For optimized solderability sensors stock should be used promptly, preferably within six months of receipt.

Export Control

For customers in Japan

For products that are controlled items subject to the “Foreign Exchange and Foreign Trade Law” of Japan, the export license specified by the law is required for export.

For customers outside Japan

Sensors should not be used or sold for use in the development, production, stockpiling or utilization of any conventional weapons or mass-destructive weapons (nuclear weapons, chemical or biological weapons, or missiles), or any other weapons.

KEMET Electronics Corporation Sales Offices

For a complete list of our global sales offices, please visit www.kemet.com/sales.

Disclaimer

All product specifications, statements, information and data (collectively, the "Information") in this datasheet are subject to change. The customer is responsible for checking and verifying the extent to which the Information contained in this publication is applicable to an order at the time the order is placed. All Information given herein is believed to be accurate and reliable, but it is presented without guarantee, warranty, or responsibility of any kind, expressed or implied. Statements of suitability for certain applications are based on KEMET Electronics Corporation's ("KEMET") knowledge of typical operating conditions for such applications, but are not intended to constitute – and KEMET specifically disclaims – any warranty concerning suitability for a specific customer application or use. The Information is intended for use only by customers who have the requisite experience and capability to determine the correct products for their application. Any technical advice inferred from this Information or otherwise provided by KEMET with reference to the use of KEMET's products is given gratis, and KEMET assumes no obligation or liability for the advice given or results obtained.

Although KEMET designs and manufactures its products to the most stringent quality and safety standards, given the current state of the art, isolated component failures may still occur. Accordingly, customer applications which require a high degree of reliability or safety should employ suitable designs or other safeguards (such as the installation of protective circuitry or redundancies) in order to ensure that the failure of an electrical component does not result in a risk of personal injury or property damage.

Although all product-related warnings, cautions and notes must be observed, the customer should not assume that all safety measures are indicated or that other measures may not be required.

KEMET is a registered trademark of KEMET Electronics Corporation.