

NOTES:
 INSULATOR MATERIAL - POLYPHENYLENE SULPHIDE, UL 94V-0
 CONTACT MATERIAL - PHOSPHOR BRONZE ALLOY
 CONTACT PLATING - GOLD OVER NICKEL UNDERPLATE
 MOUNTING OPTION - 01-No Mounting Lugs
 CONTACT TYPE - 542-Wire Wrap .045 Sq.(1.14 Sq.) - Tail LG=.750(19.05)

TOLERANCE UNLESS OTHERWISE SPECIFIED	
.XX	±.01
.XXX	±.005
.XXXX	±.0005

THIS IS A C.A.D. GENERATED DRAWING
 DO NOT MAKE MANUAL REVISIONS TO MASTER.



ISSUE NUMBER	
ORIGINAL	①

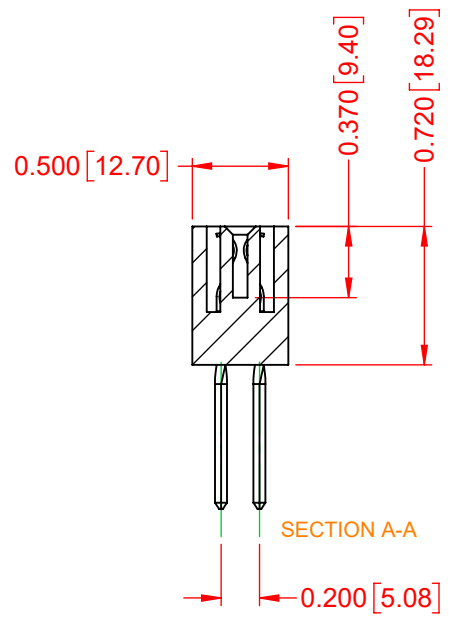
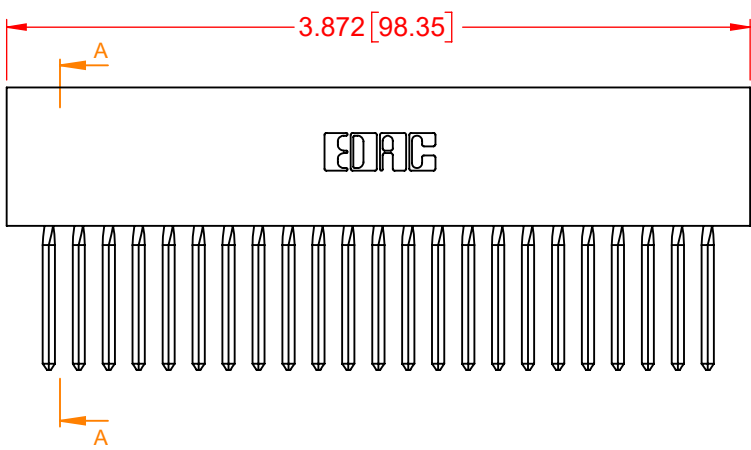
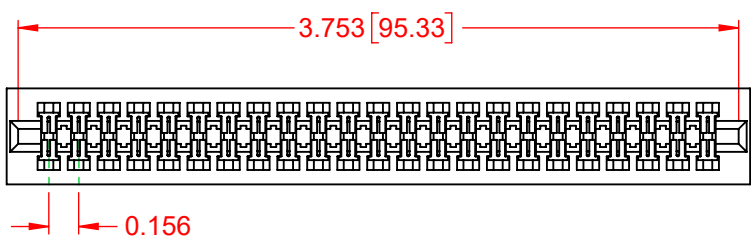

317 SERIES CARD EDGE CONNECTOR

ACAD REFERENCE NO.: 317 Assembly	
DRAWN: C.B	DATE: February 5, 2020
CHECKED:	DATE:
SCALE: 1:1	SHEET 1 OF 1
DRAWING NUMBER: 317-046-542-801	ISSUE
PART NUMBER: 317-046-542-801	1



THIS SERIES FULLY CONFORMS TO
 THE EUROPEAN UNION DIRECTIVES
 2011/65/EU FOR RoHS COMPLIANCY.

EDAC EDAC INC
 TORONTO, ONTARIO
 CANADA
 YOUR CONNECTION TO QUALITY & SERVICE

THESE DRAWINGS AND SPECIFICATIONS
 ARE THE PROPERTY OF EDAC INC., AND
 SHALL NOT BE REPRODUCED, OR COPIED
 OR USED AS THE BASIS FOR THE
 MANUFACTURE OR SALE OF APPARATUS
 WITHOUT WRITTEN PERMISSION.