

RECOMMENDED PCB LAYOUT

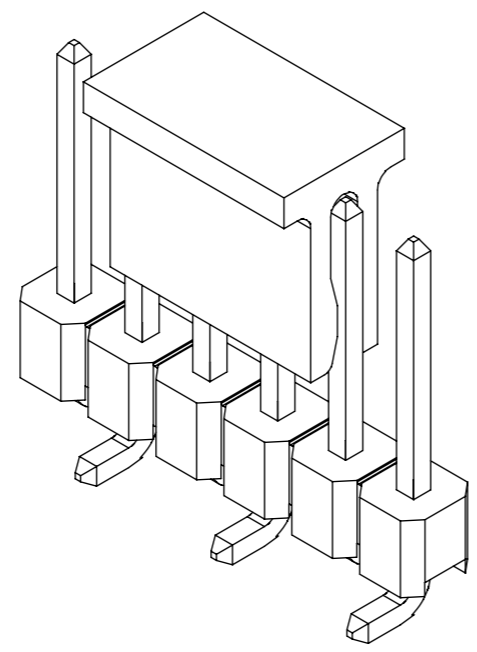
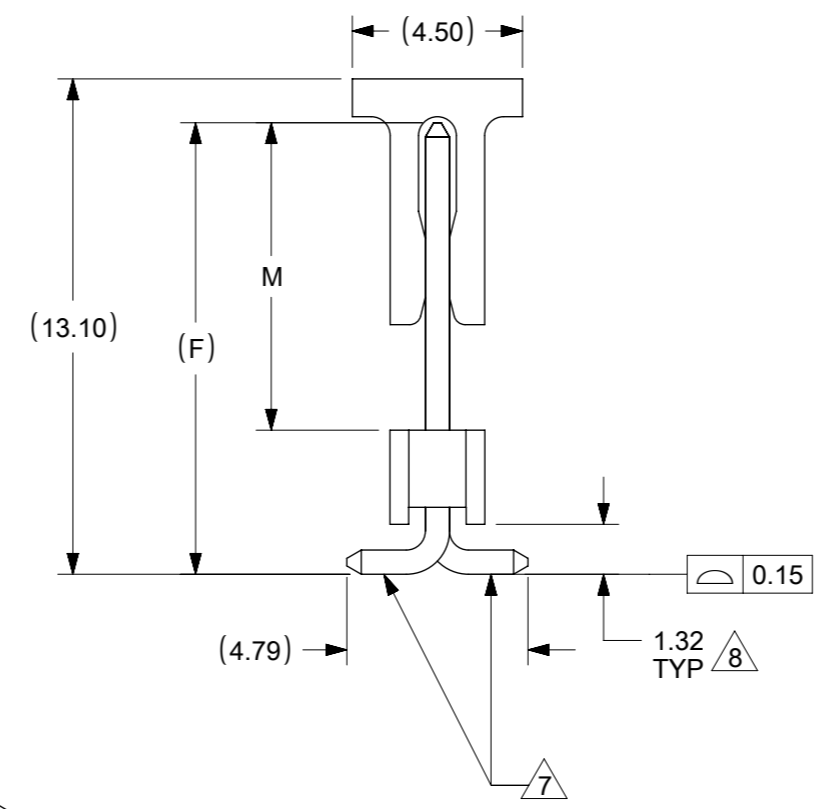
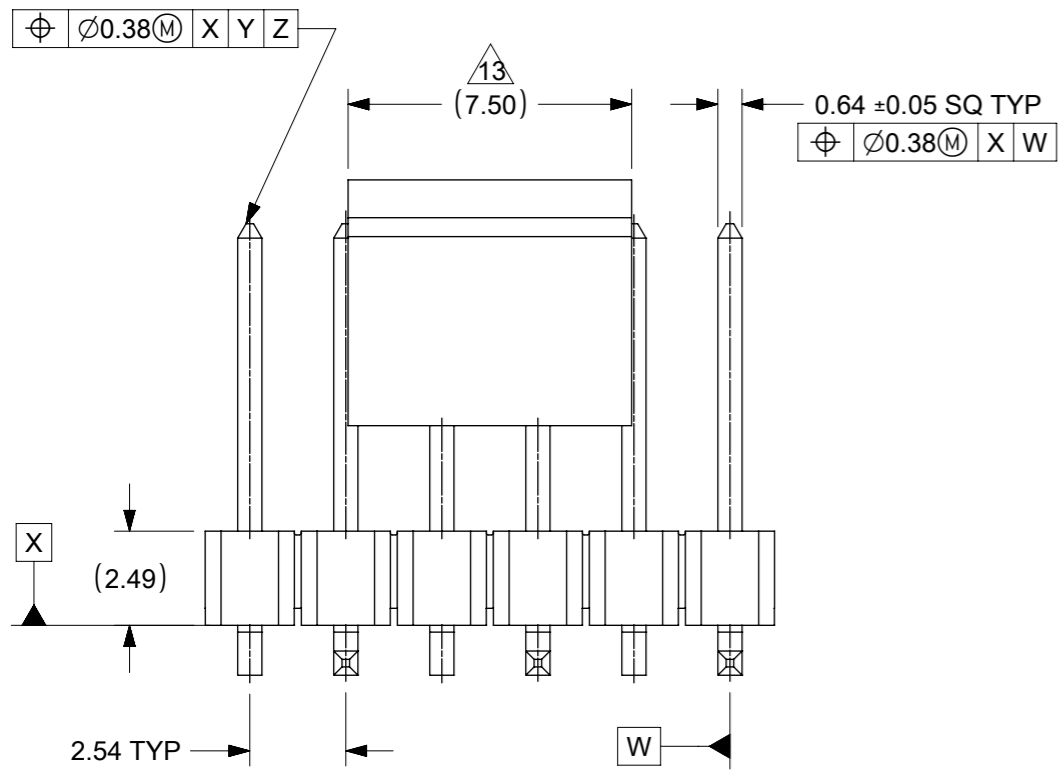

NOTES:

1. MATERIAL:
HSG: NYLON, GLASS-FILLED, UL94V-0, COLOR: BLACK
PIN: 0.64MM SQ, COPPER ALLOY
2. PLATING TYPE:
 - (1) GOLD FLASH OVER
1.25µm MIN. NICKEL OVERALL.
 - (2) GOLD FLASH ON CONTACT AND
2.50µm MIN. TIN ON SOLDER TAIL OVER
1.25µm MIN. NICKEL OVERALL.
 - (4) 0.38µm MIN. GOLD PLATE ON CONTACT AND
2.00µm MIN. TIN ON SOLDER TAIL OVER
1.25µm MIN. NICKEL OVERALL.
 - (5) 0.75µm MIN. GOLD PLATE ON CONTACT AND
2.00µm MIN. TIN ON SOLDER TAIL OVER
1.25µm MIN. NICKEL OVERALL.
 - (6) 2.50µm MIN. TIN OVERALL
1.25µm MIN. NICKEL OVERALL
3. PRODUCT SPECIFICATION: PS-87920-019
4. PACKAGING TYPE: SEE TABLE
5. PACKAGING SPEC: PK-89990-545(TUBE), PK-89990-486(T&R) & PK-87898-400 (T&R)
6. WAFER TO BE FLAT WITHIN 0.003 mm/mm
7. BEND DEPRESSION IS ACCEPTED SO LONG AS IT DOES NOT AFFECT THE OVERALL COPLANARITY OF TAIL
8. COPLANARITY IS TO BE MEASURED BY RESTING THE SOLDER TAIL ON A FLAT SURFACE
9. IRREGULAR CIRCUIT CUTOFF WITHIN BREAKAWAY SECTION IS PERMISSIBLE. CUTTING OR CHIPPING OF THE MAIN BODY IS NOT ACCEPTABLE
10. TUBE LENGTH AS PER STANDARD 560mm
11. RECOMMENDED PCB THICKNESS IS 1.60mm±0.10
12. THE ABOVE CKT 6 IS FOR ILLUSTRATION PURPOSE ONLY
13. CAP LOCATION IS CENTERED ALONG THE MATING ENDS AS SHOWN. TOP SURFACE OF CAP TO BE FLAT FOR THE PURPOSE OF PICK & PLACE BY VACUUM SUCTION NOZZLE.

THIS DRAWING CONTAINS INFORMATION THAT IS PROPRIETARY TO MOLEX ELECTRONIC TECHNOLOGIES, LLC AND SHOULD NOT BE USED WITHOUT WRITTEN PERMISSION		CURRENT REV DESC:		molex	
DIMENSION UNITS: mm		SCALE: NTS			
GENERAL TOLERANCES (UNLESS SPECIFIED)				PRODUCT CUSTOMER DRAWING	
				DOCUMENT NUMBER: SD-87898-003	
4 PLACES ±		MM INCH		DOC TYPE: PSD	
3 PLACES ±				DOC PART: 001	
2 PLACES ± 0.2				REVISION: C1	
1 PLACE ±					
0 PLACES ±					
ANGULAR TOL ± 3.0°					
DRAFT WHERE APPLICABLE MUST REMAIN WITHIN DIMENSIONS		THIRD ANGLE PROJECTION		SHEET NUMBER: 1 OF 17	
		DRAWING: A3-SIZE		SERIES: 87898	
		MATERIAL NUMBER: SEE TABLE		CUSTOMER: GENERAL MARKET	
EC NO: 698212		DRWN: DANUSA 2022/03/03			
CHK'D: DANUSA 2022/03/04		APPR: MRAMAKRISHNA 2022/03/04			
INITIAL REVISION:		DRWN: SKLIM01 2005/10/26			
		APPR: PTLIM 2005/11/07			

9 8 7 6 5 4 3 2 1

E
D
C
B
A

PART WITHOUT CAP
IN TUBE
ORIENTATION

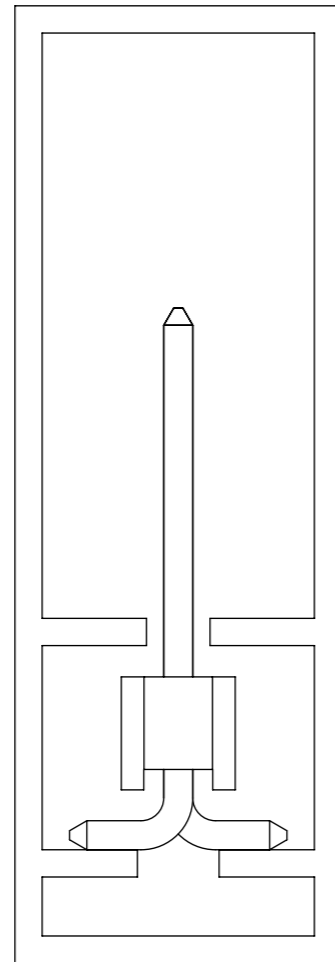

PART WITH CAP
IN TUBE
ORIENTATION

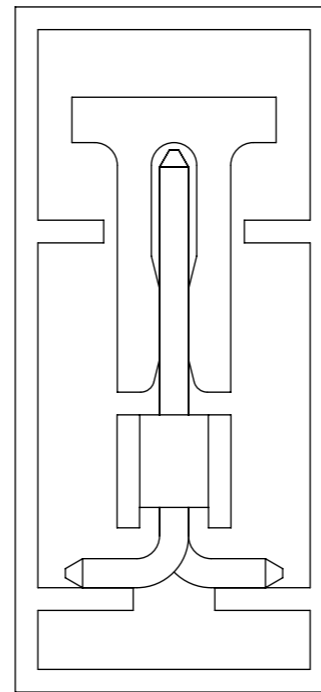

THIS DRAWING CONTAINS INFORMATION THAT IS PROPRIETARY TO MOLEX ELECTRONIC TECHNOLOGIES, LLC AND SHOULD NOT BE USED WITHOUT WRITTEN PERMISSION									
DIMENSION UNITS		SCALE		CURRENT REV DESC:				molex	
mm		NTS							
GENERAL TOLERANCES (UNLESS SPECIFIED)				EC NO: 698212				CUSTOM HEADER	
				DRWN: DANUSA 2022/03/03				2.54MM PITCH SINGLE ROW SINGLE WAFER SMT	
				CHK'D: DANUSA 2022/03/04				HEADER	
				APPR: MRAMAKRISHNA 2022/03/04				PRODUCT CUSTOMER DRAWING	
4 PLACES ±				INITIAL REVISION:				DOCUMENT NUMBER	
3 PLACES ±				DRWN: SKLIM01 2005/10/26				SD-87898-003	
2 PLACES ± 0.2				APPR: PTLIM 2005/11/07				DOC TYPE	
1 PLACE ±								PSD	
0 PLACES ±								DOC PART	
ANGULAR TOL ± 3.0°								001	
DRAFT WHERE APPLICABLE MUST REMAIN WITHIN DIMENSIONS				THIRD ANGLE PROJECTION		DRAWING		SERIES	
				A3-SIZE		87898		MATERIAL NUMBER	
				SEE TABLE		CUSTOMER		SHEET NUMBER	
				GENERAL MARKET		2 OF 17			

DOCUMENT STATUS	P1	RELEASE DATE	2022/03/04	09:00:56
-----------------	----	--------------	------------	----------

9 8 7 6 5 4 3 2 1

FORMAT: Mef-lega-master-ib-prod-A3
REVISION: D
DATE: 2018/01/18

CKT	DIMENSION						QTY/REEL
	Bo	Ao	Ko	F	So	W	
3	8.02	5.20	13.60	11.50	--	24.00	320
4	10.51	5.79	15.05	14.20	28.40	32.00	250
5	13.10	5.20	13.60	11.50	---	24.00	320

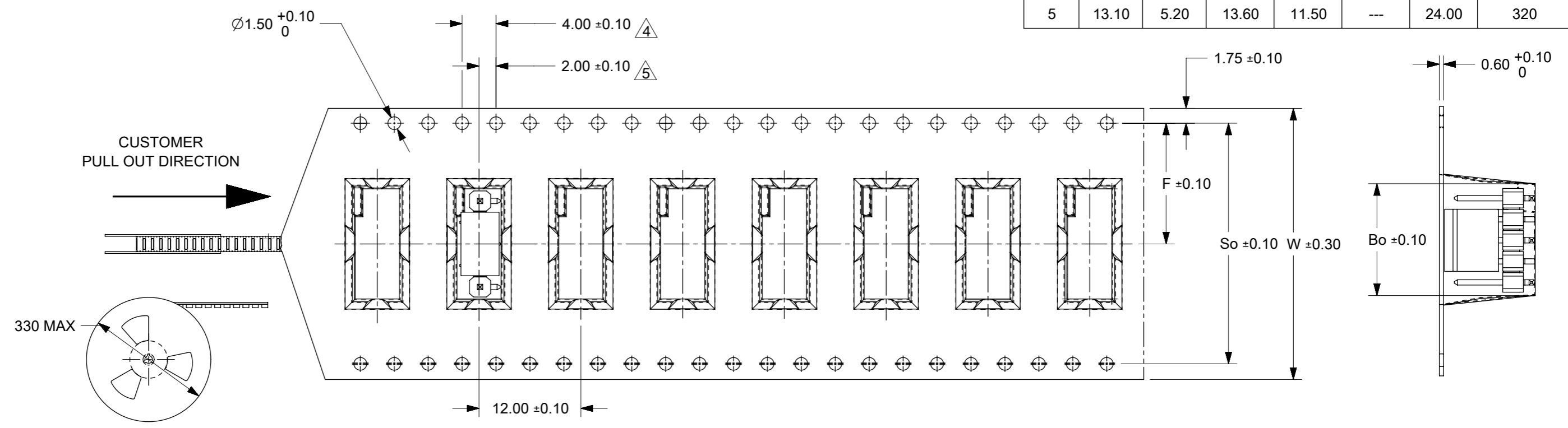

NOTES:

1. LEADER AND TRAILER TAPE

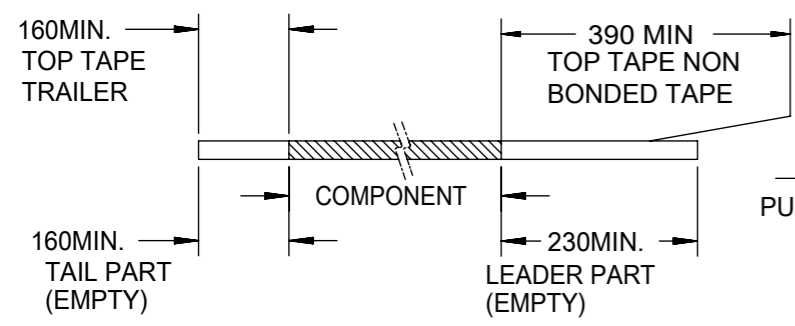

PART PACK IN E/TAPE ORIENTATION (FOR REF USE)

2. PEELING OFF FORCE OF THE TOP TAPE: 20 - 80gf. (PEELING DIRECTION AS SHOWN IN FOLLOWING FIGURE)

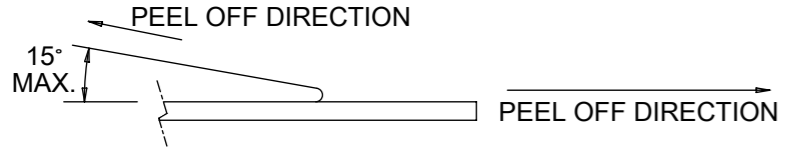

- 3. MATERIAL: BLACK P.S CONDUCTIVE, BLACK
- 4. MEASURED FROM CENTRELINE OF SPROCKET HOLE TO CENTRELINE OF POCKET
- 5. CUMULATIVE TOLERANCE OF 10 SPROCKET HOLE IS $\pm 0.20\text{mm}$
- 6. A0 AND B0 ARE MEASURE FROM ABOVE POCKET BASE 0.30mm
- 7. TAPE AND REEL SPECIFICATION IS AS PER EIA-481.
- 8. THE TAPE IS TREATED FOR ANTI-STATIC.
- 9. ALL RADIUS ARE 0.30MM UNLESS SPECIFY
- 10. SURFACE RESISTIVITY 10^3 TO 10 OHMS.

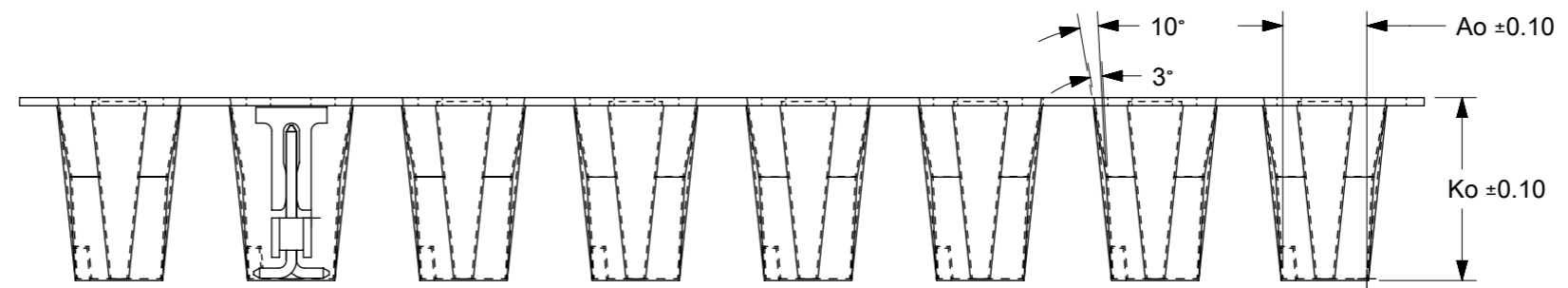

THIS DRAWING CONTAINS INFORMATION THAT IS PROPRIETARY TO MOLEX ELECTRONIC TECHNOLOGIES, LLC AND SHOULD NOT BE USED WITHOUT WRITTEN PERMISSION

DIMENSION UNITS	SCALE	CURRENT REV DESC:		molex		
mm	NTS					
GENERAL TOLERANCES (UNLESS SPECIFIED)		EC NO: 698212		CUSTOMER		
		DRWN: DANUSA 2022/03/03		2.54MM PITCH SINGLE ROW SINGLE WAFER SMT HEADER		
		CHK'D: DANUSA 2022/03/04		PRODUCT CUSTOMER DRAWING		
		APPR: MRAMAKRISHNA 2022/03/04		DOCUMENT NUMBER		
		INITIAL REVISION:		SD-87898-003		
		DRWN: SKLIM01 2005/10/26		DOC TYPE		
		APPR: PTLIM 2005/11/07		PSD		
		ANGULAR TOL $\pm 3.0^\circ$		DOC PART		
		DRAFT WHERE APPLICABLE MUST REMAIN WITHIN DIMENSIONS		001		
		THIRD ANGLE PROJECTION		REVISION		
		DRAWING		C1		
		SERIES		SHEET NUMBER		
		A3-SIZE 87898		3 OF 17		
		MATERIAL NUMBER		CUSTOMER		
		SEE TABLE		GENERAL MARKET		

9 8 7 6 5 4 3 2 1

PACKAGING OPTION PART NO.						CKT SIZE	VOID POSITION	PLATING TYPE	DIMENSION			
TRAY WITHOUT CAP	TRAY WITH CAP	TUBE WITHOUT CAP	TUBE WITH CAP	TAPE & REEL WITHOUT CAP	TAPE & REEL WITH CAP				A	B	F	M
-----	(C) 87898-0361	-----	-----	-----	-----	3	----	1	7.62	5.08	11.94	8.13
-----	(C) 87898-0362	-----	-----	-----	-----	3	----	2	7.62	5.08	11.94	8.13
-----	(C) 87898-0364	-----	-----	-----	87898-0369	3	----	4	7.62	5.08	11.94	8.13
-----	(C) 87898-0365	-----	-----	-----	-----	3	----	5	7.62	5.08	11.94	8.13
-----	(C) 87898-0366	-----	87898-0367	-----	87898-0368	3	----	6	7.62	5.08	11.94	8.13

E

E

D

D

C

C

B

B

A

A

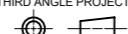
THIS DRAWING CONTAINS INFORMATION THAT IS PROPRIETARY TO MOLEX ELECTRONIC TECHNOLOGIES, LLC AND SHOULD NOT BE USED WITHOUT WRITTEN PERMISSION																	
DIMENSION UNITS		SCALE		CURRENT REV DESC:													
mm		NTS															
GENERAL TOLERANCES (UNLESS SPECIFIED)				EC NO: 698212 DRWN: DANUSA 2022/03/03 CHK'D: DANUSA 2022/03/04 APPR: MRAMAKRISHNA 2022/03/04 INITIAL REVISION: DRWN: SKLIM01 2005/10/26 APPR: PTLIM 2005/11/07						CUSTOMER DRAWING							
										PRODUCT CUSTOMER DRAWING							
4 PLACES ±		±								DOCUMENT NUMBER				SD-87898-003			
3 PLACES ±		±								DOC TYPE				PSD			
2 PLACES ±		0.2 ±								DOC PART				001			
1 PLACE ±		±		REVISION				C1									
0 PLACES ±		±		MATERIAL NUMBER				SEE TABLE									
ANGULAR TOL ±		3.0°		CUSTOMER				GENERAL MARKET									
DRAFT WHERE APPLICABLE MUST REMAIN WITHIN DIMENSIONS				THIRD ANGLE PROJECTION		DRAWING		SERIES		SHEET NUMBER							
						A3-SIZE		87898		4 OF 17							

DOCUMENT STATUS	P1	RELEASE DATE	2022/03/04	09:00:56
-----------------	----	--------------	------------	----------

9 8 7 6 5 4 3 2 1

FORMAT: Mel-lega-master-ib-prod-A3
 REVISION: D
 DATE: 2018/01/18

PACKAGING OPTION PART NO.						CKT SIZE	PEG	VOID POSITION	PLATING TYPE	DIMENSION			
TRAY WITHOUT CAP	TRAY WITH CAP	TUBE WITHOUT CAP	TUBE WITH CAP	TAPE & REEL WITHOUT CAP	TAPE & REEL WITH CAP					A	B	F	M
-----	-----	87898-0461	-----	-----	-----	4	---	----	1	10.16	7.62	11.94	8.13
-----	-----	87898-0462	-----	-----	-----	4	---	----	2	10.16	7.62	11.94	8.13
-----	-----	87898-0464	-----	-----	-----	4	---	----	4	10.16	7.62	11.94	8.13
-----	-----	87898-0465	-----	-----	-----	4	---	----	5	10.16	7.62	11.94	8.13
-----	-----	87898-0466	-----	-----	87898-0467	4	---	----	6	10.16	7.62	11.94	8.13
-----	-----	-----	-----	-----	87898-0468	4	Y	----	6	10.16	7.62	11.94	8.13
-----	-----	-----	-----	87898-0489	-----	4	Y	----	5	10.16	7.62	16.74	12.93
-----	-----	87898-0561	-----	-----	-----	5	---	----	1	12.70	10.16	11.94	8.13
-----	-----	87898-0562	-----	-----	-----	5	---	----	2	12.70	10.16	11.94	8.13
-----	-----	87898-0564	-----	-----	-----	5	---	----	4	12.70	10.16	11.94	8.13
-----	-----	87898-0565	-----	-----	-----	5	---	----	5	12.70	10.16	11.94	8.13
-----	-----	87898-0566	87898-0567	-----	87898-0568	5	---	----	6	12.70	10.16	11.94	8.13
-----	-----	87898-0661	-----	-----	-----	6	---	----	1	15.24	12.70	11.94	8.13
-----	-----	87898-0662	-----	-----	-----	6	---	----	2	15.24	12.70	11.94	8.13
-----	-----	87898-0664	-----	-----	-----	6	---	----	4	15.24	12.70	11.94	8.13
-----	-----	87898-0665	-----	-----	(C) -----	6	---	----	5	15.24	12.70	11.94	8.13
-----	-----	87898-0666	-----	-----	87898-0605	6	---	----	6	15.24	12.70	11.94	8.13

4 CKT WITH PEG FOR ILLUSTRATION ONLY

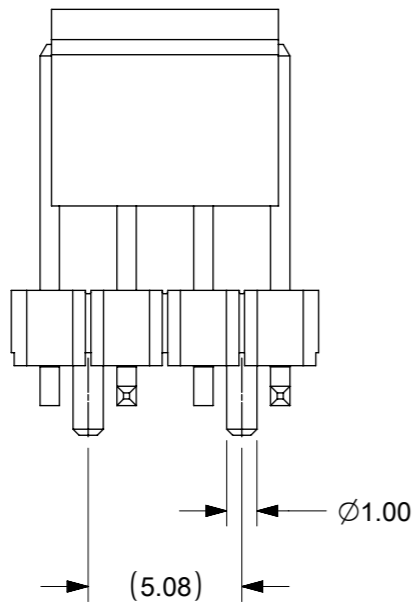

THIS DRAWING CONTAINS INFORMATION THAT IS PROPRIETARY TO MOLEX ELECTRONIC TECHNOLOGIES, LLC AND SHOULD NOT BE USED WITHOUT WRITTEN PERMISSION											
DIMENSION UNITS		SCALE		CURRENT REV DESC:							
mm		NTS									
GENERAL TOLERANCES (UNLESS SPECIFIED)				EC NO: 698212		DRWN: DANUSA		2022/03/03		CUSTOM HEADER 2.54MM PITCH SINGLE ROW SINGLE WAFER SMT HEADER	
				CHK'D: DANUSA		2022/03/04					
4 PLACES ±				APPR: MRAMAKRISHNA		2022/03/04		PRODUCT CUSTOMER DRAWING			
3 PLACES ±				INITIAL REVISION:		DRWN: SKLIM01		2005/10/26		DOCUMENT NUMBER	
2 PLACES ± 0.2				APPR: PTLIM		2005/11/07		SD-87898-003		DOC TYPE DOC PART REVISION	
1 PLACE ±				THIRD ANGLE PROJECTION		DRAWING		SERIES		MATERIAL NUMBER	
0 PLACES ±				DRAFT WHERE APPLICABLE MUST REMAIN WITHIN DIMENSIONS		A3-SIZE		87898		CUSTOMER	
ANGULAR TOL ± 3.0°								SEE TABLE		GENERAL MARKET	
SHEET NUMBER				5 OF 17							

PACKAGING OPTION PART NO.						CKT SIZE	VOID POSITION	PLATING TYPE	DIMENSION			
TRAY WITHOUT CAP	TRAY WITH CAP	TUBE WITHOUT CAP	TUBE WITH CAP	TAPE & REEL WITHOUT CAP	TAPE & REEL WITH CAP				A	B	F	M
-----	-----	87898-0761	-----	-----	-----	7	----	1	17.78	15.24	11.94	8.13
-----	-----	87898-0762	-----	-----	-----	7	----	2	17.78	15.24	11.94	8.13
-----	-----	87898-0764	-----	-----	-----	7	----	4	17.78	15.24	11.94	8.13
-----	-----	87898-0765	-----	-----	-----	7	----	5	17.78	15.24	11.94	8.13
-----	-----	87898-0766	-----	-----	-----	7	----	6	17.78	15.24	11.94	8.13
-----	-----	87898-0861	-----	-----	-----	8	----	1	20.32	17.78	11.94	8.13
-----	-----	87898-0862	-----	-----	-----	8	----	2	20.32	17.78	11.94	8.13
-----	-----	87898-0864	-----	-----	-----	8	----	4	20.32	17.78	11.94	8.13
-----	-----	87898-0865	-----	-----	-----	8	----	5	20.32	17.78	11.94	8.13
-----	-----	87898-0866	-----	-----	-----	8	----	6	20.32	17.78	11.94	8.13
-----	-----	87898-0961	-----	-----	-----	9	----	1	22.86	20.32	11.94	8.13
-----	-----	87898-0962	-----	-----	-----	9	----	2	22.86	20.32	11.94	8.13
-----	-----	87898-0964	-----	-----	-----	9	----	4	22.86	20.32	11.94	8.13
-----	-----	87898-0965	-----	-----	-----	9	----	5	22.86	20.32	11.94	8.13
-----	-----	87898-0966	-----	-----	-----	9	----	6	22.86	20.32	11.94	8.13

THIS DRAWING CONTAINS INFORMATION THAT IS PROPRIETARY TO MOLEX ELECTRONIC TECHNOLOGIES, LLC AND SHOULD NOT BE USED WITHOUT WRITTEN PERMISSION												
DIMENSION UNITS		SCALE		CURRENT REV DESC:								
mm		NTS										
GENERAL TOLERANCES (UNLESS SPECIFIED)				EC NO: 698212 DRWN: DANUSA 2022/03/03 CHK'D: DANUSA 2022/03/04 APPR: MRAMAKRISHNA 2022/03/04				CUSTOM HEADER 2.54MM PITCH SINGLE ROW SINGLE WAFER SMT HEADER				
		MM	INCH									
4 PLACES	±		±	INITIAL REVISION: DRWN: SKLIM01 2005/10/26 APPR: PTLIM 2005/11/07				DOCUMENT NUMBER		DOC TYPE	DOC PART	REVISION
3 PLACES	±		±					SD-87898-003		PSD	001	C1
2 PLACES	±	0.2	±	DRAFT WHERE APPLICABLE MUST REMAIN WITHIN DIMENSIONS				MATERIAL NUMBER		CUSTOMER		SHEET NUMBER
1 PLACE	±		±					SEE TABLE		GENERAL MARKET		6 OF 17
0 PLACES	±		±	THIRD ANGLE PROJECTION		DRAWING	SERIES	A3-SIZE		87898		
ANGULAR TOL		± 3.0°		DRAWING		SERIES		MATERIAL NUMBER		CUSTOMER		

PACKAGING OPTION PART NO.						CKT SIZE	VOID POSITION	PLATING TYPE	DIMENSION			
TRAY WITHOUT CAP	TRAY WITH CAP	TUBE WITHOUT CAP	TUBE WITH CAP	TAPE & REEL WITHOUT CAP	TAPE & REEL WITH CAP				A	B	F	M
-----	-----	87898-1061	-----	-----	-----	10	----	1	25.40	22.86	11.94	8.13
-----	-----	87898-1062	-----	-----	-----	10	----	2	25.40	22.86	11.94	8.13
-----	-----	87898-1064	-----	-----	-----	10	----	4	25.40	22.86	11.94	8.13
-----	-----	87898-1065	-----	-----	-----	10	----	5	25.40	22.86	11.94	8.13
-----	-----	87898-1066	-----	-----	-----	10	----	6	25.40	22.86	11.94	8.13
-----	-----	87898-1161	-----	-----	-----	11	----	1	27.94	25.40	11.94	8.13
-----	-----	87898-1162	-----	-----	-----	11	----	2	27.94	25.40	11.94	8.13
-----	-----	87898-1164	-----	-----	-----	11	----	4	27.94	25.40	11.94	8.13
-----	-----	87898-1165	-----	-----	-----	11	----	5	27.94	25.40	11.94	8.13
-----	-----	87898-1166	-----	-----	-----	11	----	6	27.94	25.40	11.94	8.13
-----	-----	87898-1261	-----	-----	-----	12	----	1	30.48	27.94	11.94	8.13
-----	-----	87898-1262	-----	-----	-----	12	----	2	30.48	27.94	11.94	8.13
-----	-----	87898-1264	-----	-----	-----	12	----	4	30.48	27.94	11.94	8.13
-----	-----	87898-1265	-----	-----	-----	12	----	5	30.48	27.94	11.94	8.13
-----	-----	87898-1266	-----	-----	-----	12	----	6	30.48	27.94	11.94	8.13

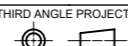
THIS DRAWING CONTAINS INFORMATION THAT IS PROPRIETARY TO MOLEX ELECTRONIC TECHNOLOGIES, LLC AND SHOULD NOT BE USED WITHOUT WRITTEN PERMISSION											
DIMENSION UNITS		SCALE		CURRENT REV DESC:							
mm		NTS		EC NO: 698212							
GENERAL TOLERANCES (UNLESS SPECIFIED)				DRWN: DANUSA		2022/03/03		CUSTOM HEADER			
				CHK'D: DANUSA		2022/03/04		2.54MM PITCH SINGLE ROW SINGLE WAFER SMT HEADER			
				APPR: MRAMAKRISHNA		2022/03/04		PRODUCT CUSTOMER DRAWING			
4 PLACES ±				INITIAL REVISION:		DRWN: SKLIM01		DOCUMENT NUMBER		DOC TYPE	
3 PLACES ±				DRWN: SKLIM01		2005/10/26		SD-87898-003		PSD	
2 PLACES ± 0.2				APPR: PTLIM		2005/11/07		001		C1	
1 PLACE ±				DRAFT WHERE APPLICABLE MUST REMAIN WITHIN DIMENSIONS		THIRD ANGLE PROJECTION		DRAWING		SERIES	
0 PLACES ±								A3-SIZE		87898	
ANGULAR TOL ± 3.0°								MATERIAL NUMBER		CUSTOMER	
								SEE TABLE		GENERAL MARKET	
										SHEET NUMBER	
										7 OF 17	

PACKAGING OPTION PART NO.						CKT SIZE	VOID POSITION	PLATING TYPE	DIMENSION			
TRAY WITHOUT CAP	TRAY WITH CAP	TUBE WITHOUT CAP	TUBE WITH CAP	TAPE & REEL WITHOUT CAP	TAPE & REEL WITH CAP				A	B	F	M
-----	-----	87898-1361	-----	-----	-----	13	----	1	33.02	30.48	11.94	8.13
-----	-----	87898-1362	-----	-----	-----	13	----	2	33.02	30.48	11.94	8.13
-----	-----	87898-1364	-----	-----	-----	13	----	4	33.02	30.48	11.94	8.13
-----	-----	87898-1365	-----	-----	-----	13	----	5	33.02	30.48	11.94	8.13
-----	-----	87898-1366	-----	-----	-----	13	----	6	33.02	30.48	11.94	8.13
-----	-----	87898-1461	-----	-----	-----	14	----	1	35.56	33.02	11.94	8.13
-----	-----	87898-1462	-----	-----	-----	14	----	2	35.56	33.02	11.94	8.13
-----	-----	87898-1464	-----	-----	-----	14	----	4	35.56	33.02	11.94	8.13
-----	-----	87898-1465	-----	-----	-----	14	----	5	35.56	33.02	11.94	8.13
-----	-----	87898-1466	-----	-----	-----	14	----	6	35.56	33.02	11.94	8.13
-----	-----	87898-1561	-----	-----	-----	15	----	1	38.10	35.56	11.94	8.13
-----	-----	87898-1562	-----	-----	-----	15	----	2	38.10	35.56	11.94	8.13
-----	-----	87898-1564	-----	-----	-----	15	----	4	38.10	35.56	11.94	8.13
-----	-----	87898-1565	-----	-----	-----	15	----	5	38.10	35.56	11.94	8.13
-----	-----	87898-1566	-----	-----	-----	15	----	6	38.10	35.56	11.94	8.13

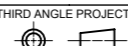
THIS DRAWING CONTAINS INFORMATION THAT IS PROPRIETARY TO MOLEX ELECTRONIC TECHNOLOGIES, LLC AND SHOULD NOT BE USED WITHOUT WRITTEN PERMISSION														
DIMENSION UNITS		SCALE		CURRENT REV DESC:										
mm		NTS												
GENERAL TOLERANCES (UNLESS SPECIFIED)				EC NO: 698212 DRWN: DANUSA 2022/03/03 CHK'D: DANUSA 2022/03/04 APPR: MRAMAKRISHNA 2022/03/04						CUSTOM HEADER 2.54MM PITCH SINGLE ROW SINGLE WAFER SMT HEADER				
		MM	INCH											
4 PLACES	±		±	INITIAL REVISION: DRWN: SKLIM01 2005/10/26 APPR: PTLIM 2005/11/07						DOCUMENT NUMBER		DOC TYPE	DOC PART	REVISION
3 PLACES	±		±							SD-87898-003		PSD	001	C1
2 PLACES	±	0.2	±	DRAFT WHERE APPLICABLE MUST REMAIN WITHIN DIMENSIONS		THIRD ANGLE PROJECTION	DRAWING	SERIES	MATERIAL NUMBER	CUSTOMER	SHEET NUMBER			
1 PLACE	±		±				A3-SIZE	87898	SEE TABLE	GENERAL MARKET	8 OF 17			
0 PLACES	±		±											
ANGULAR TOL		± 3.0°												

PACKAGING OPTION PART NO.						CKT SIZE	VOID POSITION	PLATING TYPE	DIMENSION			
TRAY WITHOUT CAP	TRAY WITH CAP	TUBE WITHOUT CAP	TUBE WITH CAP	TAPE & REEL WITHOUT CAP	TAPE & REEL WITH CAP				A	B	F	M
-----	-----	87898-1661	-----	-----	-----	16	----	1	40.64	38.10	11.94	8.13
-----	-----	87898-1662	-----	-----	-----	16	----	2	40.64	38.10	11.94	8.13
-----	-----	87898-1664	-----	-----	-----	16	----	4	40.64	38.10	11.94	8.13
-----	-----	87898-1665	-----	-----	-----	16	----	5	40.64	38.10	11.94	8.13
-----	-----	87898-1666	-----	-----	-----	16	----	6	40.64	38.10	11.94	8.13
-----	-----	87898-1761	-----	-----	-----	17	----	1	43.18	40.64	11.94	8.13
-----	-----	87898-1762	-----	-----	-----	17	----	2	43.18	40.64	11.94	8.13
-----	-----	87898-1764	-----	-----	-----	17	----	4	43.18	40.64	11.94	8.13
-----	-----	87898-1765	-----	-----	-----	17	----	5	43.18	40.64	11.94	8.13
-----	-----	87898-1766	-----	-----	-----	17	----	6	43.18	40.64	11.94	8.13
-----	-----	87898-1861	-----	-----	-----	18	----	1	45.72	43.18	11.94	8.13
-----	-----	87898-1862	-----	-----	-----	18	----	2	45.72	43.18	11.94	8.13
-----	-----	87898-1864	-----	-----	-----	18	----	4	45.72	43.18	11.94	8.13
-----	-----	87898-1865	-----	-----	-----	18	----	5	45.72	43.18	11.94	8.13
-----	-----	87898-1866	-----	-----	-----	18	----	6	45.72	43.18	11.94	8.13

THIS DRAWING CONTAINS INFORMATION THAT IS PROPRIETARY TO MOLEX ELECTRONIC TECHNOLOGIES, LLC AND SHOULD NOT BE USED WITHOUT WRITTEN PERMISSION

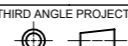
DIMENSION UNITS		SCALE		CURRENT REV DESC:								
mm		NTS		EC NO: 698212								
GENERAL TOLERANCES (UNLESS SPECIFIED)				DRWN: DANUSA 2022/03/03				CUSTOM HEADER 2.54MM PITCH SINGLE ROW SINGLE WAFER SMT HEADER				
				CHK'D: DANUSA 2022/03/04								
				APPR: MRAMAKRISHNA 2022/03/04				PRODUCT CUSTOMER DRAWING				
				INITIAL REVISION:				DOCUMENT NUMBER		DOC TYPE	DOC PART	REVISION
4 PLACES ±				DRWN: SKLIM01 2005/10/26				SD-87898-003		PSD	001	C1
3 PLACES ±				APPR: PTLIM 2005/11/07								
2 PLACES ± 0.2												
1 PLACE ±												
0 PLACES ±												
ANGULAR TOL ± 3.0°				THIRD ANGLE PROJECTION		DRAWING	SERIES	MATERIAL NUMBER		CUSTOMER		SHEET NUMBER
DRAFT WHERE APPLICABLE MUST REMAIN WITHIN DIMENSIONS						A3-SIZE	87898	SEE TABLE		GENERAL MARKET	9 OF 17	

FORMAT: Mel-lega-master-ib-prod-A3
 REVISION: D
 DATE: 2018/01/18

PACKAGING OPTION PART NO.						CKT SIZE	VOID POSITION	PLATING TYPE	DIMENSION			
TRAY WITHOUT CAP	TRAY WITH CAP	TUBE WITHOUT CAP	TUBE WITH CAP	TAPE & REEL WITHOUT CAP	TAPE & REEL WITH CAP				A	B	F	M
-----	-----	87898-1961	-----	-----	-----	19	----	1	48.26	45.72	11.94	8.13
-----	-----	87898-1962	-----	-----	-----	19	----	2	48.26	45.72	11.94	8.13
-----	-----	87898-1964	-----	-----	-----	19	----	4	48.26	45.72	11.94	8.13
-----	-----	87898-1965	-----	-----	-----	19	----	5	48.26	45.72	11.94	8.13
-----	-----	87898-1966	-----	-----	-----	19	----	6	48.26	45.72	11.94	8.13
-----	-----	87898-2061	-----	-----	-----	20	----	1	50.80	48.26	11.94	8.13
-----	-----	87898-2062	-----	-----	-----	20	----	2	50.80	48.26	11.94	8.13
-----	-----	87898-2064	-----	-----	-----	20	----	4	50.80	48.26	11.94	8.13
-----	-----	87898-2065	-----	-----	-----	20	----	5	50.80	48.26	11.94	8.13
-----	-----	87898-2066	-----	-----	-----	20	----	6	50.80	48.26	11.94	8.13
-----	-----	87898-2161	-----	-----	-----	21	----	1	53.34	50.80	11.94	8.13
-----	-----	87898-2162	-----	-----	-----	21	----	2	53.34	50.80	11.94	8.13
-----	-----	87898-2164	-----	-----	-----	21	----	4	53.34	50.80	11.94	8.13
-----	-----	87898-2165	-----	-----	-----	21	----	5	53.34	50.80	11.94	8.13
-----	-----	87898-2166	-----	-----	-----	21	----	6	53.34	50.80	11.94	8.13

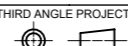
THIS DRAWING CONTAINS INFORMATION THAT IS PROPRIETARY TO MOLEX ELECTRONIC TECHNOLOGIES, LLC AND SHOULD NOT BE USED WITHOUT WRITTEN PERMISSION													
DIMENSION UNITS		SCALE		CURRENT REV DESC:									
mm		NTS											
GENERAL TOLERANCES (UNLESS SPECIFIED)				EC NO: 698212 DRWN: DANUSA 2022/03/03 CHK'D: DANUSA 2022/03/04 APPR: MRAMAKRISHNA 2022/03/04						CUSTOM HEADER 2.54MM PITCH SINGLE ROW SINGLE WAFER SMT HEADER			
4 PLACES		±	±	INITIAL REVISION: DRWN: SKLIM01 2005/10/26 APPR: PTLIM 2005/11/07						PRODUCT CUSTOMER DRAWING DOCUMENT NUMBER: SD-87898-003 DOC TYPE: PSD DOC PART: 001 REVISION: C1			
3 PLACES		±	±										
2 PLACES		± 0.2	±	DRAFT WHERE APPLICABLE MUST REMAIN WITHIN DIMENSIONS						THIRD ANGLE PROJECTION 			
1 PLACE		±	±										
0 PLACES		±	±	DRAWING		SERIES		MATERIAL NUMBER		CUSTOMER		SHEET NUMBER	
ANGULAR TOL		± 3.0°		A3-SIZE		87898		SEE TABLE		GENERAL MARKET		10 OF 17	

PACKAGING OPTION PART NO.						CKT SIZE	VOID POSITION	PLATING TYPE	DIMENSION			
TRAY WITHOUT CAP	TRAY WITH CAP	TUBE WITHOUT CAP	TUBE WITH CAP	TAPE & REEL WITHOUT CAP	TAPE & REEL WITH CAP				A	B	F	M
-----	-----	87898-2261	-----	-----	-----	22	----	1	55.88	53.34	11.94	8.13
-----	-----	87898-2262	-----	-----	-----	22	----	2	55.88	53.34	11.94	8.13
-----	-----	87898-2264	-----	-----	-----	22	----	4	55.88	53.34	11.94	8.13
-----	-----	87898-2265	-----	-----	-----	22	----	5	55.88	53.34	11.94	8.13
-----	-----	87898-2266	-----	-----	-----	22	----	6	55.88	53.34	11.94	8.13
-----	-----	87898-2361	-----	-----	-----	23	----	1	58.42	55.88	11.94	8.13
-----	-----	87898-2362	-----	-----	-----	23	----	2	58.42	55.88	11.94	8.13
-----	-----	87898-2364	-----	-----	-----	23	----	4	58.42	55.88	11.94	8.13
-----	-----	87898-2365	-----	-----	-----	23	----	5	58.42	55.88	11.94	8.13
-----	-----	87898-2366	-----	-----	-----	23	----	6	58.42	55.88	11.94	8.13
-----	-----	87898-2461	-----	-----	-----	24	----	1	60.96	58.42	11.94	8.13
-----	-----	87898-2462	-----	-----	-----	24	----	2	60.96	58.42	11.94	8.13
-----	-----	87898-2464	-----	-----	-----	24	----	4	60.96	58.42	11.94	8.13
-----	-----	87898-2465	-----	-----	-----	24	----	5	60.96	58.42	11.94	8.13
-----	-----	87898-2466	-----	-----	-----	24	----	6	60.96	58.42	11.94	8.13

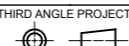
THIS DRAWING CONTAINS INFORMATION THAT IS PROPRIETARY TO MOLEX ELECTRONIC TECHNOLOGIES, LLC AND SHOULD NOT BE USED WITHOUT WRITTEN PERMISSION												
DIMENSION UNITS		SCALE		CURRENT REV DESC:								
mm		NTS										
GENERAL TOLERANCES (UNLESS SPECIFIED)				EC NO: 698212 DRWN: DANUSA 2022/03/03 CHK'D: DANUSA 2022/03/04 APPR: MRAMAKRISHNA 2022/03/04				CUSTOM HEADER 2.54MM PITCH SINGLE ROW SINGLE WAFER SMT HEADER				
		MM	INCH									
4 PLACES	±		±	INITIAL REVISION: DRWN: SKLIM01 2005/10/26 APPR: PTLIM 2005/11/07				DOCUMENT NUMBER		DOC TYPE	DOC PART	REVISION
3 PLACES	±		±					SD-87898-003		PSD	001	C1
2 PLACES	±	0.2	±	DRAFT WHERE APPLICABLE MUST REMAIN WITHIN DIMENSIONS				MATERIAL NUMBER		CUSTOMER		SHEET NUMBER
1 PLACE	±		±					SEE TABLE		GENERAL MARKET		11 OF 17
0 PLACES	±		±	THIRD ANGLE PROJECTION		DRAWING	SERIES					
ANGULAR TOL		± 3.0°				A3-SIZE	87898					

PACKAGING OPTION PART NO.						CKT SIZE	VOID POSITION	PLATING TYPE	DIMENSION			
TRAY WITHOUT CAP	TRAY WITH CAP	TUBE WITHOUT CAP	TUBE WITH CAP	TAPE & REEL WITHOUT CAP	TAPE & REEL WITH CAP				A	B	F	M
-----	-----	87898-2561	-----	-----	-----	25	----	1	63.50	60.96	11.94	8.13
-----	-----	87898-2562	-----	-----	-----	25	----	2	63.50	60.96	11.94	8.13
-----	-----	87898-2564	-----	-----	-----	25	----	4	63.50	60.96	11.94	8.13
-----	-----	87898-2565	-----	-----	-----	25	----	5	63.50	60.96	11.94	8.13
-----	-----	87898-2566	-----	-----	-----	25	----	6	63.50	60.96	11.94	8.13
-----	-----	87898-2661	-----	-----	-----	26	----	1	66.04	63.50	11.94	8.13
-----	-----	87898-2662	-----	-----	-----	26	----	2	66.04	63.50	11.94	8.13
-----	-----	87898-2664	-----	-----	-----	26	----	4	66.04	63.50	11.94	8.13
-----	-----	87898-2665	-----	-----	-----	26	----	5	66.04	63.50	11.94	8.13
-----	-----	87898-2666	-----	-----	-----	26	----	6	66.04	63.50	11.94	8.13
-----	-----	87898-2761	-----	-----	-----	27	----	1	68.58	66.04	11.94	8.13
-----	-----	87898-2762	-----	-----	-----	27	----	2	68.58	66.04	11.94	8.13
-----	-----	87898-2764	-----	-----	-----	27	----	4	68.58	66.04	11.94	8.13
-----	-----	87898-2765	-----	-----	-----	27	----	5	68.58	66.04	11.94	8.13
-----	-----	87898-2766	-----	-----	-----	27	----	6	68.58	66.04	11.94	8.13

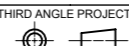
THIS DRAWING CONTAINS INFORMATION THAT IS PROPRIETARY TO MOLEX ELECTRONIC TECHNOLOGIES, LLC AND SHOULD NOT BE USED WITHOUT WRITTEN PERMISSION												
DIMENSION UNITS		SCALE		CURRENT REV DESC:								
mm		NTS										
GENERAL TOLERANCES (UNLESS SPECIFIED)				EC NO: 698212 DRWN: DANUSA 2022/03/03 CHK'D: DANUSA 2022/03/04 APPR: MRAMAKRISHNA 2022/03/04				CUSTOM HEADER 2.54MM PITCH SINGLE ROW SINGLE WAFER SMT HEADER				
		MM	INCH									
4 PLACES	±		±	INITIAL REVISION: DRWN: SKLIM01 2005/10/26 APPR: PTLIM 2005/11/07				DOCUMENT NUMBER		DOC TYPE	DOC PART	REVISION
3 PLACES	±		±					SD-87898-003		PSD	001	C1
2 PLACES	±	0.2	±	DRAFT WHERE APPLICABLE MUST REMAIN WITHIN DIMENSIONS				MATERIAL NUMBER		CUSTOMER		SHEET NUMBER
1 PLACE	±		±					SEE TABLE		GENERAL MARKET		12 OF 17
0 PLACES	±		±	THIRD ANGLE PROJECTION		DRAWING	SERIES	CUSTOMER		SHEET NUMBER		
ANGULAR TOL ± 3.0°				A3-SIZE	87898	SEE TABLE		GENERAL MARKET		12 OF 17		

PACKAGING OPTION PART NO.						CKT SIZE	VOID POSITION	PLATING TYPE	DIMENSION			
TRAY WITHOUT CAP	TRAY WITH CAP	TUBE WITHOUT CAP	TUBE WITH CAP	TAPE & REEL WITHOUT CAP	TAPE & REEL WITH CAP				A	B	F	M
-----	-----	87898-2861	-----	-----	-----	28	----	1	71.12	68.58	11.94	8.13
-----	-----	87898-2862	-----	-----	-----	28	----	2	71.12	68.58	11.94	8.13
-----	-----	87898-2864	-----	-----	-----	28	----	4	71.12	68.58	11.94	8.13
-----	-----	87898-2865	-----	-----	-----	28	----	5	71.12	68.58	11.94	8.13
-----	-----	87898-2866	-----	-----	-----	28	----	6	71.12	68.58	11.94	8.13
-----	-----	87898-2961	-----	-----	-----	29	----	1	73.66	71.12	11.94	8.13
-----	-----	87898-2962	-----	-----	-----	29	----	2	73.66	71.12	11.94	8.13
-----	-----	87898-2964	-----	-----	-----	29	----	4	73.66	71.12	11.94	8.13
-----	-----	87898-2965	-----	-----	-----	29	----	5	73.66	71.12	11.94	8.13
-----	-----	87898-2966	-----	-----	-----	29	----	6	73.66	71.12	11.94	8.13
-----	-----	87898-3061	-----	-----	-----	30	----	1	76.20	73.66	11.94	8.13
-----	-----	87898-3062	-----	-----	-----	30	----	2	76.20	73.66	11.94	8.13
-----	-----	87898-3064	-----	-----	-----	30	----	4	76.20	73.66	11.94	8.13
-----	-----	87898-3065	-----	-----	-----	30	----	5	76.20	73.66	11.94	8.13
-----	-----	87898-3066	-----	-----	-----	30	----	6	76.20	73.66	11.94	8.13

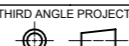
THIS DRAWING CONTAINS INFORMATION THAT IS PROPRIETARY TO MOLEX ELECTRONIC TECHNOLOGIES, LLC AND SHOULD NOT BE USED WITHOUT WRITTEN PERMISSION												
DIMENSION UNITS		SCALE		CURRENT REV DESC:								
mm		NTS										
GENERAL TOLERANCES (UNLESS SPECIFIED)				EC NO: 698212 DRWN: DANUSA 2022/03/03 CHK'D: DANUSA 2022/03/04 APPR: MRAMAKRISHNA 2022/03/04				CUSTOM HEADER 2.54MM PITCH SINGLE ROW SINGLE WAFER SMT HEADER				
		MM	INCH									
4 PLACES	±		±	INITIAL REVISION: DRWN: SKLIM01 2005/10/26 APPR: PTLIM 2005/11/07				DOCUMENT NUMBER		DOC TYPE	DOC PART	REVISION
3 PLACES	±		±					SD-87898-003		PSD	001	C1
2 PLACES	±	0.2	±	DRAFT WHERE APPLICABLE MUST REMAIN WITHIN DIMENSIONS				MATERIAL NUMBER		CUSTOMER		SHEET NUMBER
1 PLACE	±		±					SEE TABLE		GENERAL MARKET		13 OF 17
0 PLACES	±		±	THIRD ANGLE PROJECTION		DRAWING	SERIES	CUSTOMER		SHEET NUMBER		
ANGULAR TOL		± 3.0°				A3-SIZE	87898	GENERAL MARKET		13 OF 17		

PACKAGING OPTION PART NO.						CKT SIZE	VOID POSITION	PLATING TYPE	DIMENSION			
TRAY WITHOUT CAP	TRAY WITH CAP	TUBE WITHOUT CAP	TUBE WITH CAP	TAPE & REEL WITHOUT CAP	TAPE & REEL WITH CAP				A	B	F	M
-----	-----	87898-3161	-----	-----	-----	31	----	1	78.74	76.20	11.94	8.13
-----	-----	87898-3162	-----	-----	-----	31	----	2	78.74	76.20	11.94	8.13
-----	-----	87898-3164	-----	-----	-----	31	----	4	78.74	76.20	11.94	8.13
-----	-----	87898-3165	-----	-----	-----	31	----	5	78.74	76.20	11.94	8.13
-----	-----	87898-3166	-----	-----	-----	31	----	6	78.74	76.20	11.94	8.13
-----	-----	87898-3261	-----	-----	-----	32	----	1	81.28	78.74	11.94	8.13
-----	-----	87898-3262	-----	-----	-----	32	----	2	81.28	78.74	11.94	8.13
-----	-----	87898-3264	-----	-----	-----	32	----	4	81.28	78.74	11.94	8.13
-----	-----	87898-3265	-----	-----	-----	32	----	5	81.28	78.74	11.94	8.13
-----	-----	87898-3266	-----	-----	-----	32	----	6	81.28	78.74	11.94	8.13
-----	-----	87898-3361	-----	-----	-----	33	----	1	83.82	81.28	11.94	8.13
-----	-----	87898-3362	-----	-----	-----	33	----	2	83.82	81.28	11.94	8.13
-----	-----	87898-3364	-----	-----	-----	33	----	4	83.82	81.28	11.94	8.13
-----	-----	87898-3365	-----	-----	-----	33	----	5	83.82	81.28	11.94	8.13
-----	-----	87898-3366	-----	-----	-----	33	----	6	83.82	81.28	11.94	8.13

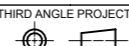
THIS DRAWING CONTAINS INFORMATION THAT IS PROPRIETARY TO MOLEX ELECTRONIC TECHNOLOGIES, LLC AND SHOULD NOT BE USED WITHOUT WRITTEN PERMISSION												
DIMENSION UNITS		SCALE		CURRENT REV DESC:								
mm		NTS										
GENERAL TOLERANCES (UNLESS SPECIFIED)				EC NO: 698212 DRWN: DANUSA 2022/03/03 CHK'D: DANUSA 2022/03/04 APPR: MRAMAKRISHNA 2022/03/04				CUSTOM HEADER 2.54MM PITCH SINGLE ROW SINGLE WAFER SMT HEADER				
		MM	INCH									
4 PLACES	±		±	INITIAL REVISION: DRWN: SKLIM01 2005/10/26 APPR: PTLIM 2005/11/07				DOCUMENT NUMBER		DOC TYPE	DOC PART	REVISION
3 PLACES	±		±					SD-87898-003		PSD	001	C1
2 PLACES	±	0.2	±	DRAFT WHERE APPLICABLE MUST REMAIN WITHIN DIMENSIONS				MATERIAL NUMBER		CUSTOMER		SHEET NUMBER
1 PLACE	±		±					SEE TABLE		GENERAL MARKET		14 OF 17
0 PLACES	±		±	THIRD ANGLE PROJECTION		DRAWING	SERIES	CUSTOMER		SHEET NUMBER		
ANGULAR TOL		± 3.0°				A3-SIZE	87898	GENERAL MARKET		14 OF 17		

PACKAGING OPTION PART NO.						CKT SIZE	VOID POSITION	PLATING TYPE	DIMENSION			
TRAY WITHOUT CAP	TRAY WITH CAP	TUBE WITHOUT CAP	TUBE WITH CAP	TAPE & REEL WITHOUT CAP	TAPE & REEL WITH CAP				A	B	F	M
-----	-----	87898-3461	-----	-----	-----	34	----	1	86.36	83.82	11.94	8.13
-----	-----	87898-3462	-----	-----	-----	34	----	2	86.36	83.82	11.94	8.13
-----	-----	87898-3464	-----	-----	-----	34	----	4	86.36	83.82	11.94	8.13
-----	-----	87898-3465	-----	-----	-----	34	----	5	86.36	83.82	11.94	8.13
-----	-----	87898-3466	-----	-----	-----	34	----	6	86.36	83.82	11.94	8.13
-----	-----	87898-3561	-----	-----	-----	35	----	1	88.90	86.36	11.94	8.13
-----	-----	87898-3562	-----	-----	-----	35	----	2	88.90	86.36	11.94	8.13
-----	-----	87898-3564	-----	-----	-----	35	----	4	88.90	86.36	11.94	8.13
-----	-----	87898-3565	-----	-----	-----	35	----	5	88.90	86.36	11.94	8.13
-----	-----	87898-3566	-----	-----	-----	35	----	6	88.90	86.36	11.94	8.13
-----	-----	87898-3661	-----	-----	-----	36	----	1	91.44	88.90	11.94	8.13
-----	-----	87898-3662	-----	-----	-----	36	----	2	91.44	88.90	11.94	8.13
-----	-----	87898-3664	-----	-----	-----	36	----	4	91.44	88.90	11.94	8.13
-----	-----	87898-3665	-----	-----	-----	36	----	5	91.44	88.90	11.94	8.13
-----	-----	87898-3666	-----	-----	-----	36	----	6	91.44	88.90	11.94	8.13

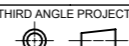
THIS DRAWING CONTAINS INFORMATION THAT IS PROPRIETARY TO MOLEX ELECTRONIC TECHNOLOGIES, LLC AND SHOULD NOT BE USED WITHOUT WRITTEN PERMISSION												
DIMENSION UNITS		SCALE		CURRENT REV DESC:								
mm		NTS										
GENERAL TOLERANCES (UNLESS SPECIFIED)				EC NO: 698212 DRWN: DANUSA 2022/03/03 CHK'D: DANUSA 2022/03/04 APPR: MRAMAKRISHNA 2022/03/04				CUSTOM HEADER 2.54MM PITCH SINGLE ROW SINGLE WAFER SMT HEADER				
		MM	INCH									
4 PLACES	±		±	INITIAL REVISION: DRWN: SKLIM01 2005/10/26 APPR: PTLIM 2005/11/07				DOCUMENT NUMBER		DOC TYPE	DOC PART	REVISION
3 PLACES	±		±					SD-87898-003		PSD	001	C1
2 PLACES	±	0.2	±	DRAFT WHERE APPLICABLE MUST REMAIN WITHIN DIMENSIONS				MATERIAL NUMBER		CUSTOMER		SHEET NUMBER
1 PLACE	±		±					SEE TABLE		GENERAL MARKET		15 OF 17
0 PLACES	±		±	THIRD ANGLE PROJECTION 		DRAWING	SERIES					
ANGULAR TOL		± 3.0°		A3-SIZE		87898						

PACKAGING OPTION PART NO.						CKT SIZE	VOID POSITION	PLATING TYPE	DIMENSION			
TRAY WITHOUT CAP	TRAY WITH CAP	TUBE WITHOUT CAP	TUBE WITH CAP	TAPE & REEL WITHOUT CAP	TAPE & REEL WITH CAP				A	B	F	M
-----	-----	87898-3761	-----	-----	-----	37	----	1	93.98	91.44	11.94	8.13
-----	-----	87898-3762	-----	-----	-----	37	----	2	93.98	91.44	11.94	8.13
-----	-----	87898-3764	-----	-----	-----	37	----	4	93.98	91.44	11.94	8.13
-----	-----	87898-3765	-----	-----	-----	37	----	5	93.98	91.44	11.94	8.13
-----	-----	87898-3766	-----	-----	-----	37	----	6	93.98	91.44	11.94	8.13
-----	-----	87898-3861	-----	-----	-----	38	----	1	96.52	93.98	11.94	8.13
-----	-----	87898-3862	-----	-----	-----	38	----	2	96.52	93.98	11.94	8.13
-----	-----	87898-3864	-----	-----	-----	38	----	4	96.52	93.98	11.94	8.13
-----	-----	87898-3865	-----	-----	-----	38	----	5	96.52	93.98	11.94	8.13
-----	-----	87898-3866	-----	-----	-----	38	----	6	96.52	93.98	11.94	8.13
-----	-----	87898-3961	-----	-----	-----	39	----	1	99.06	96.52	11.94	8.13
-----	-----	87898-3962	-----	-----	-----	39	----	2	99.06	96.52	11.94	8.13
-----	-----	87898-3964	-----	-----	-----	39	----	4	99.06	96.52	11.94	8.13
-----	-----	87898-3965	-----	-----	-----	39	----	5	99.06	96.52	11.94	8.13
-----	-----	87898-3966	-----	-----	-----	39	----	6	99.06	96.52	11.94	8.13

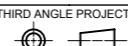
THIS DRAWING CONTAINS INFORMATION THAT IS PROPRIETARY TO MOLEX ELECTRONIC TECHNOLOGIES, LLC AND SHOULD NOT BE USED WITHOUT WRITTEN PERMISSION											
DIMENSION UNITS		SCALE		CURRENT REV DESC:							
mm		NTS		EC NO: 698212							
GENERAL TOLERANCES (UNLESS SPECIFIED)				DRWN: DANUSA		2022/03/03		CUSTOM HEADER			
				CHK'D: DANUSA		2022/03/04		2.54MM PITCH SINGLE ROW SINGLE WAFER SMT HEADER			
				APPR: MRAMAKRISHNA		2022/03/04		PRODUCT CUSTOMER DRAWING			
				INITIAL REVISION:				DOCUMENT NUMBER		DOC TYPE DOC PART REVISION	
				DRWN: SKLIM01		2005/10/26		SD-87898-003		PSD 001 C1	
				APPR: PTLIM		2005/11/07		MATERIAL NUMBER		CUSTOMER	
				ANGULAR TOL ± 3.0°				SEE TABLE		GENERAL MARKET	
DRAFT WHERE APPLICABLE MUST REMAIN WITHIN DIMENSIONS				THIRD ANGLE PROJECTION		DRAWING		SERIES		SHEET NUMBER	
						A3-SIZE		87898		16 OF 17	

9 8 7 6 5 4 3 2 1

PACKAGING OPTION PART NO.						CKT SIZE	VOID POSITION	PLATING TYPE	DIMENSION			
TRAY WITHOUT CAP	TRAY WITH CAP	TUBE WITHOUT CAP	TUBE WITH CAP	TAPE & REEL WITHOUT CAP	TAPE & REEL WITH CAP				A	B	F	M
-----	-----	87898-4061	-----	-----	-----	40	----	1	101.6	99.06	11.94	8.13
-----	-----	87898-4062	-----	-----	-----	40	----	2	101.6	99.06	11.94	8.13
-----	-----	87898-4064	-----	-----	-----	40	----	4	101.6	99.06	11.94	8.13
-----	-----	87898-4065	-----	-----	-----	40	----	5	101.6	99.06	11.94	8.13
-----	-----	87898-4066	-----	-----	-----	40	----	6	101.6	99.06	11.94	8.13

E

E

D

D

C

C

B

B

A

A

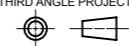
THIS DRAWING CONTAINS INFORMATION THAT IS PROPRIETARY TO MOLEX ELECTRONIC TECHNOLOGIES, LLC AND SHOULD NOT BE USED WITHOUT WRITTEN PERMISSION												
DIMENSION UNITS		SCALE		CURRENT REV DESC:								
mm		NTS										
GENERAL TOLERANCES (UNLESS SPECIFIED)				EC NO: 698212 DRWN: DANUSA 2022/03/03 CHK'D: DANUSA 2022/03/04 APPR: MRAMAKRISHNA 2022/03/04				CUSTOM HEADER 2.54MM PITCH SINGLE ROW SINGLE WAFER SMT HEADER				
		MM	INCH									
4 PLACES	±		±	INITIAL REVISION: DRWN: SKLIM01 2005/10/26 APPR: PTLIM 2005/11/07				DOCUMENT NUMBER		DOC TYPE	DOC PART	REVISION
3 PLACES	±		±					SD-87898-003		PSD	001	C1
2 PLACES	±	0.2	±	DRAFT WHERE APPLICABLE MUST REMAIN WITHIN DIMENSIONS				MATERIAL NUMBER		CUSTOMER		SHEET NUMBER
1 PLACE	±		±					SEE TABLE		GENERAL MARKET		17 OF 17
0 PLACES	±		±	THIRD ANGLE PROJECTION 		DRAWING	SERIES	A3-SIZE 87898				
ANGULAR TOL ± 3.0°												

DOCUMENT STATUS	P1	RELEASE DATE	2022/03/04	09:00:56
-----------------	----	--------------	------------	----------

9 8 7 6 5 4 3 2 1

FORMAT: Mol-lega-master-ib-prod-A3
 REVISION: D
 DATE: 2018/01/18