

## CARMEN-50-M-C

~35° medium beam. Assembly with holder C compatible with LEDiL HEKLA.

### SPECIFICATION:

Dimensions	Ø 50.0 mm
Height	25.5 mm
Fastening	socket
ROHS compliant	yes ⓘ

### MATERIALS:

Component	Type	Material	Colour	Finish
CARMEN-50-M	Single lens	PMMA	clear	
CARMEN-50-HLD-C	Holder	PC	black	

### ORDERING INFORMATION:

Component	Type	Qty in box	MOQ	MPQ	Box weight (kg)
CP16108_CARMEN-50-M-C » Box size: 476 x 273 x 292 mm	Single lens	308	112	28	5.9

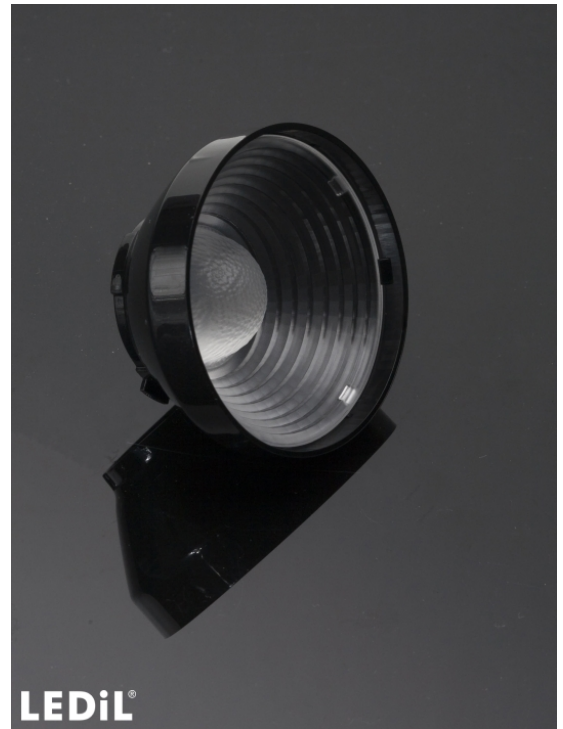

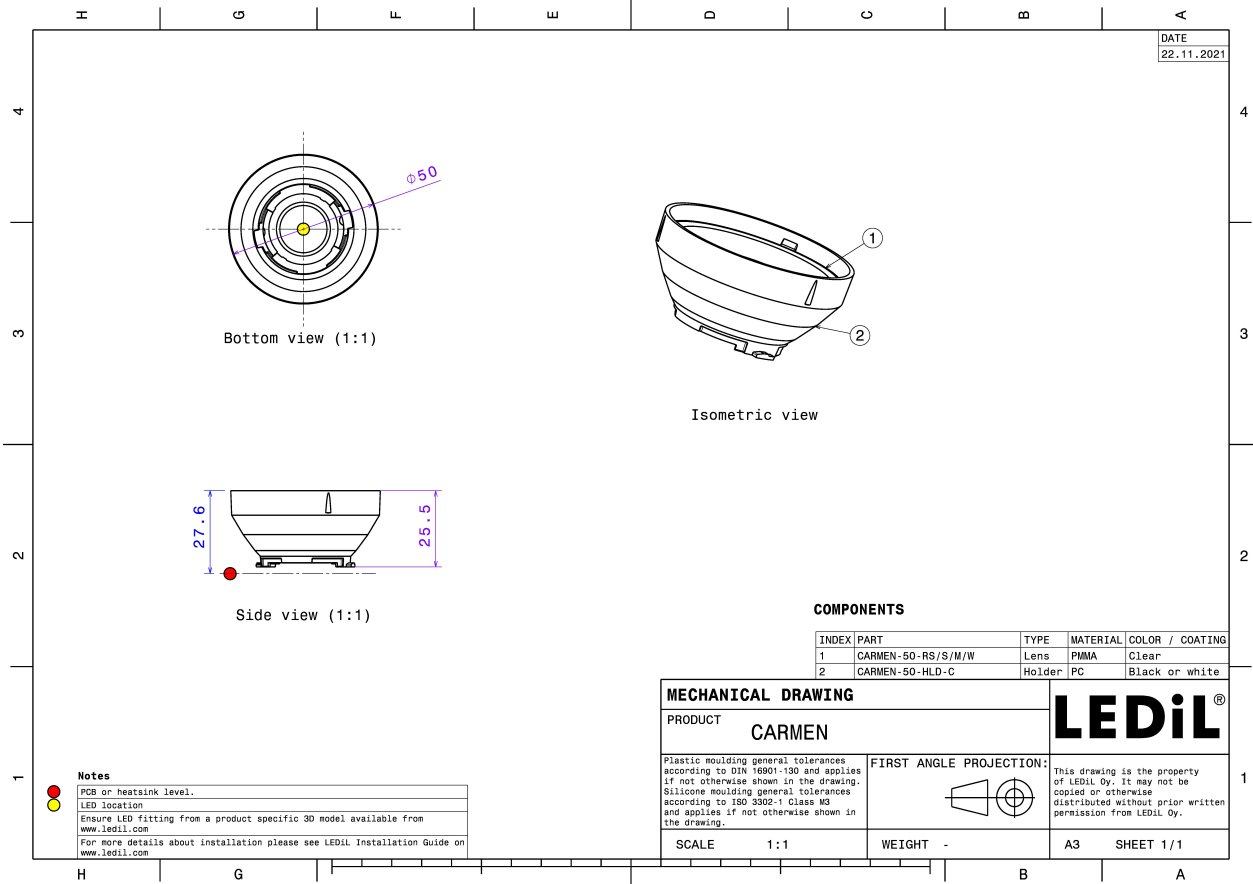









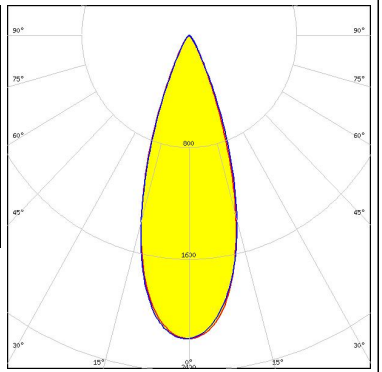

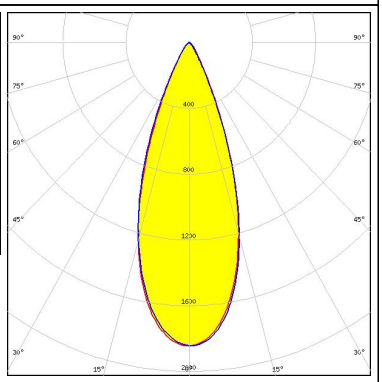

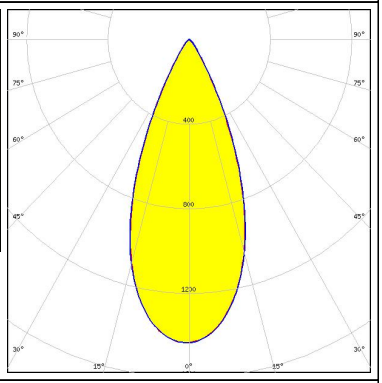

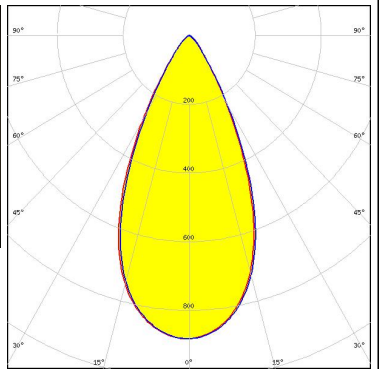

See also our general installation guide: [www.ledil.com/installation\\_guide](http://www.ledil.com/installation_guide)

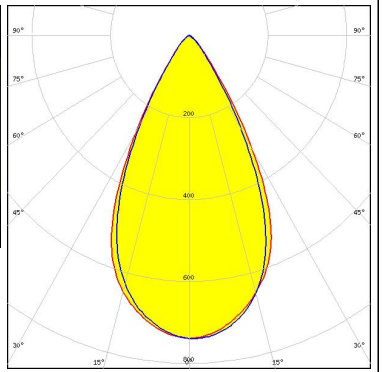

#### OPTICAL RESULTS (MEASURED):

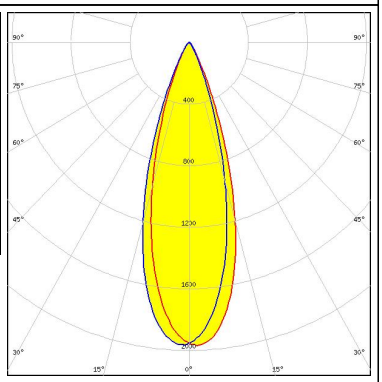
<p></p> <p>LED V4 HD Gen 7            FWHM / FWTM 35.0° / 57.0°            Efficiency 84 %            Peak intensity 2.2 cd/lm            LEDs/each optic 1            Light colour White            Required components:            F15253_HEKLA-SOCKET-A</p>		
<p></p> <p>LED V6 HD Gen 7            FWHM / FWTM 38.0° / 60.0°            Efficiency 81 %            Peak intensity 1.9 cd/lm            LEDs/each optic 1            Light colour White            Required components:            F15255_HEKLA-SOCKET-C</p>		
<p></p> <p>LED V9 HD Gen7            FWHM / FWTM 43.0° / 65.0°            Efficiency 75 %            Peak intensity 1.4 cd/lm            LEDs/each optic 1            Light colour White            Required components:            F15859_HEKLA-SOCKET-I</p>		
<p></p> <p>LED VERO13            FWHM / FWTM 49.0° / 75.0°            Efficiency 62 %            Peak intensity 0.9 cd/lm            LEDs/each optic 1            Light colour White            Required components:            C16142_HEKLA-SOCKET-K</p>		

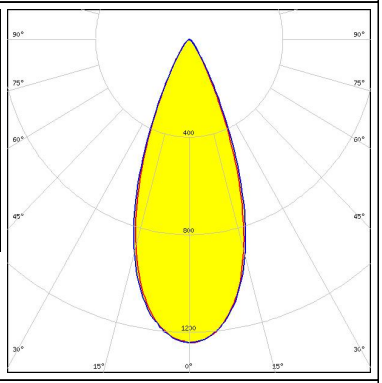
#### OPTICAL RESULTS (MEASURED):

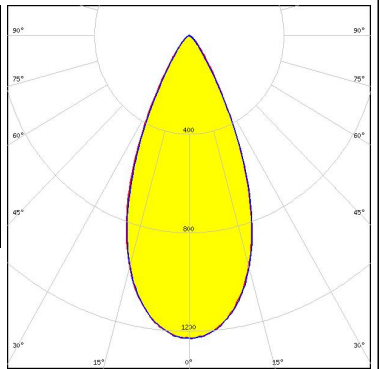
<p></p> <p>LED Vesta DTW 13mm (21W)            FWHM / FWTM 55.0° / 79.0°            Efficiency 59 %            Peak intensity 0.7 cd/lm            LEDs/each optic 1            Light colour Tunable White</p> <p>Required components:            C16142_HEKLA-SOCKET-K            Bender Wirth: 491 Typ L8</p>		
<p></p> <p>LED Vesta TW 6mm DP            FWHM / FWTM 32.0° / 55.0°            Efficiency 67 %            Peak intensity 2 cd/lm            LEDs/each optic 1            Light colour White</p> <p>Required components:            C16142_HEKLA-SOCKET-K            Bender Wirth: 504 Typ L8</p>		
<p></p> <p>LED Vesta TW 9mm (9W) DP            FWHM / FWTM 41.0° / 65.0°            Efficiency 62 %            Peak intensity 1.2 cd/lm            LEDs/each optic 1            Light colour White</p> <p>Required components:            C16142_HEKLA-SOCKET-K            Bender Wirth: 489 Typ L8</p>		
<p><b>CITIZEN</b></p> <p>LED CLL02x/CLU02x (LES10)            FWHM / FWTM 46.0° / 72.0°            Efficiency 76 %            Peak intensity 1.2 cd/lm            LEDs/each optic 1            Light colour White</p> <p>Required components:            F15255_HEKLA-SOCKET-C</p>		

#### OPTICAL RESULTS (MEASURED):

#### CITIZEN

LED CLU700/701/702/703  
 FWHM / FWTM 36.0° / 59.0°  
 Efficiency 80 %  
 Peak intensity 1.9 cd/lm  
 LEDs/each optic 1  
 Light colour White  
 Required components:  
 F15255\_HEKLA-SOCKET-C

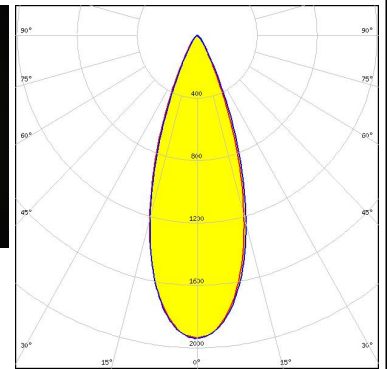
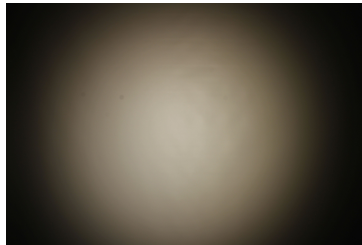

#### CITIZEN

LED CLU710/711  
 FWHM / FWTM 41.0° / 65.0°  
 Efficiency 73 %  
 Peak intensity 1.4 cd/lm  
 LEDs/each optic 1  
 Light colour White  
 Required components:  
 F15859\_HEKLA-SOCKET-I

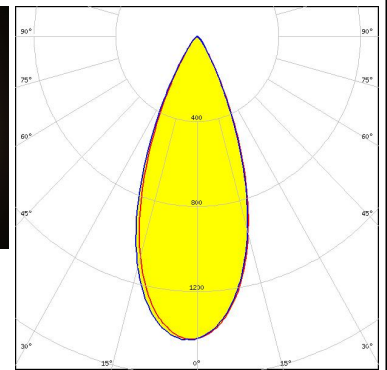
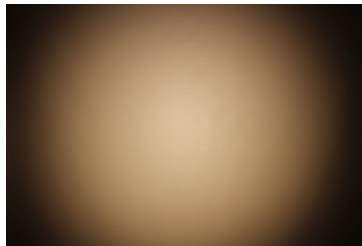

#### CITIZEN

LED CLU7A2/7A3  
 FWHM / FWTM 35.0° / 56.0°  
 Efficiency 84 %  
 Peak intensity 2.2 cd/lm  
 LEDs/each optic 1  
 Light colour White  
 Required components:  
 F15255\_HEKLA-SOCKET-C

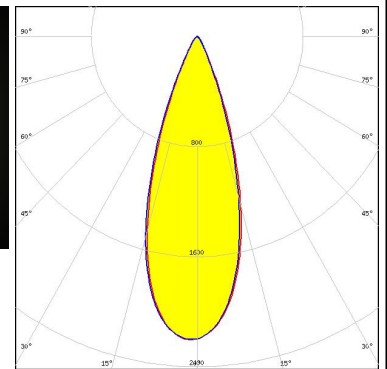
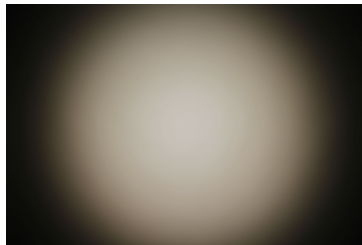





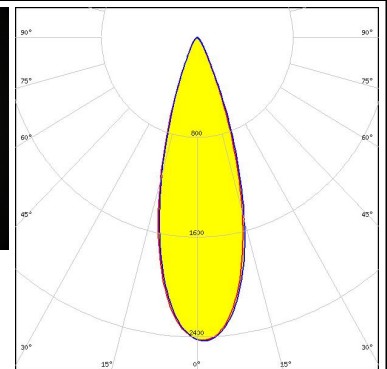
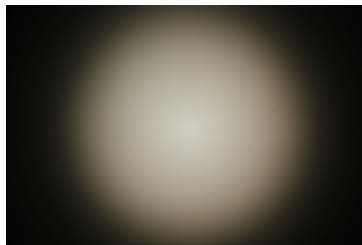

#### CITIZEN

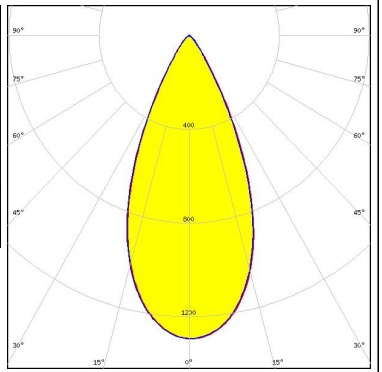
LED CLU7B2  
 FWHM / FWTM 32.0° / 53.0°  
 Efficiency 82 %  
 Peak intensity 2.4 cd/lm  
 LEDs/each optic 1  
 Light colour White  
 Required components:  
 F15255\_HEKLA-SOCKET-C

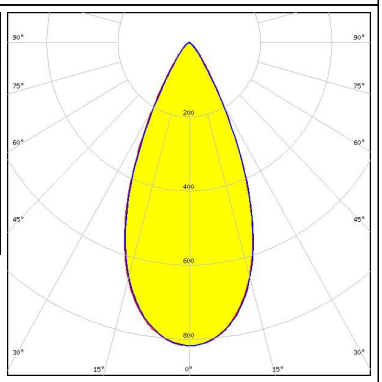

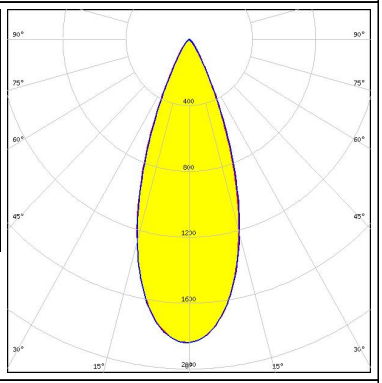

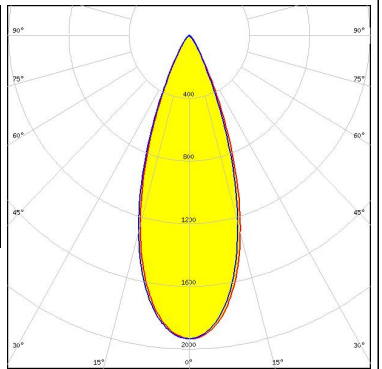



#### OPTICAL RESULTS (MEASURED):

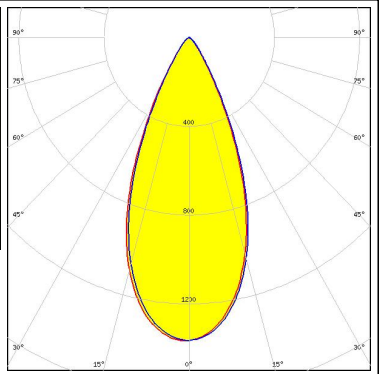

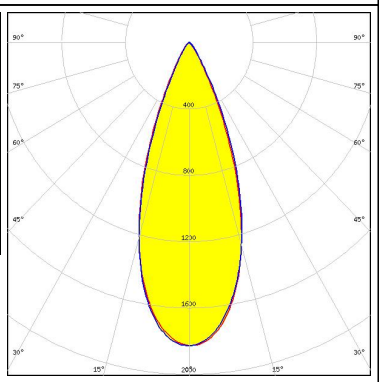

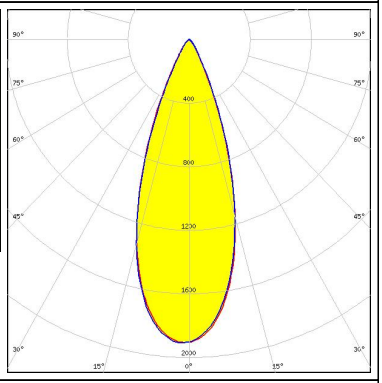

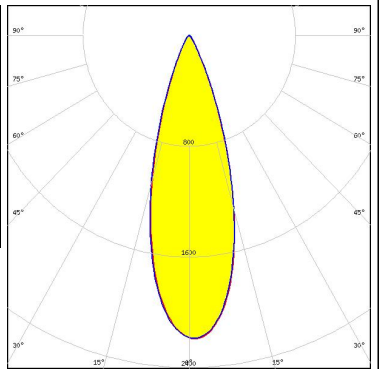
<p><b>CREE</b> → <b>LED</b></p> <p>LED CMA1516            FWHM / FWTM 46.0° / 71.0°            Efficiency 79 %            Peak intensity 1.3 cd/m            LEDs/each optic 1            Light colour White            Required components:            F15256_HEKLA-SOCKET-D</p>		
<p><b>CREE</b> → <b>LED</b></p> <p>LED CMT14xx            FWHM / FWTM 47.0° / 72.0°            Efficiency 51 %            Peak intensity 0.8 cd/m            LEDs/each optic 1            Light colour White            Required components:            F15255_HEKLA-SOCKET-C</p>		
<p><b>CREE</b> → <b>LED</b></p> <p>LED CXA/B 13xx            FWHM / FWTM 38.0° / 62.0°            Efficiency 83 %            Peak intensity 1.8 cd/m            LEDs/each optic 1            Light colour White            Required components:            F15956_HEKLA-SOCKET-J</p>		
<p><b>CREE</b> → <b>LED</b></p> <p>LED CXA/B 13xx            FWHM / FWTM 37.0° / 61.0°            Efficiency 83 %            Peak intensity 1.9 cd/m            LEDs/each optic 1            Light colour White            Required components:            F15956_HEKLA-SOCKET-J</p>		

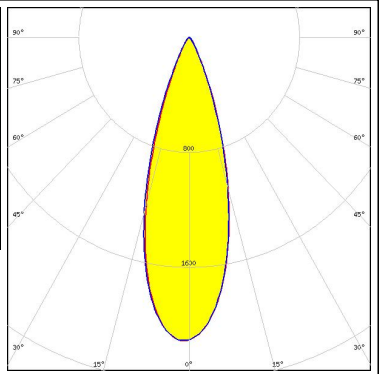

#### OPTICAL RESULTS (MEASURED):

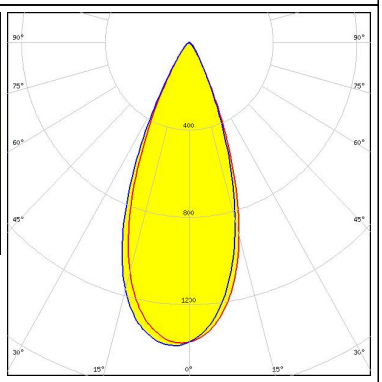
<p><b>CREE</b> LED</p> <p>LED: CXA/B 15xx            FWHM / FWTM: 45.0° / 69.0°            Efficiency: 79 %            Peak intensity: 1.4 cd/lm            LEDs/each optic: 1            Light colour: White            Required components:            F15256_HEKLA-SOCKET-D</p>		
<p><b>LUMILEDS</b></p> <p>LED: LUXEON CoB 1202HD            FWHM / FWTM: 38.0° / 61.0°            Efficiency: 82 %            Peak intensity: 1.8 cd/lm            LEDs/each optic: 1            Light colour: White            Required components:            F15848_HEKLA-SOCKET-G</p>		
<p><b>LUMILEDS</b></p> <p>LED: LUXEON CoB 1202s            FWHM / FWTM: 37.0° / 60.0°            Efficiency: 81 %            Peak intensity: 1.9 cd/lm            LEDs/each optic: 1            Light colour: White            Required components:            F15848_HEKLA-SOCKET-G</p>		
<p><b>LUMILEDS</b></p> <p>LED: LUXEON CX Plus CoB - HD S01H4            FWHM / FWTM: 32.0° / 54.0°            Efficiency: 73 %            Peak intensity: 2.2 cd/lm            LEDs/each optic: 1            Light colour: White            Required components:            Bender Wirth: 634c Hekla</p>		

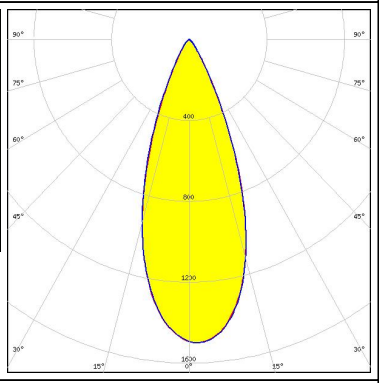
#### OPTICAL RESULTS (MEASURED):

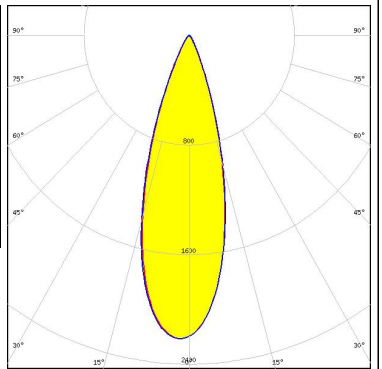
<p><b>LUMILEDS</b></p> <p>LED LUXEON CX Plus CoB - HD S01H6 / HD S02H6</p> <p>FWHM / FWTM 32.0° / 54.0°</p> <p>Efficiency 72 %</p> <p>Peak intensity 2.1 cd/lm</p> <p>LEDs/each optic 1</p> <p>Light colour White</p> <p>Required components: Bender Wirth: 634c Hekla</p>		
<p><b>LUMILEDS</b></p> <p>LED LUXEON CX Plus CoB - HD S04H9</p> <p>FWHM / FWTM 41.0° / 65.0°</p> <p>Efficiency 70 %</p> <p>Peak intensity 1.4 cd/lm</p> <p>LEDs/each optic 1</p> <p>Light colour White</p> <p>Required components: Bender Wirth: 634c Hekla</p>		
<p><b>LUMILEDS</b></p> <p>LED LUXEON CX Plus CoB M02 / M03 (Gen2)</p> <p>FWHM / FWTM 39.0° / 62.0°</p> <p>Efficiency 69 %</p> <p>Peak intensity 1.5 cd/lm</p> <p>LEDs/each optic 1</p> <p>Light colour White</p> <p>Required components: Bender Wirth: 641a Hekla</p>		
<p><b>LUMILEDS</b></p> <p>LED LUXEON CX Plus CoB S01 (Gen2)</p> <p>FWHM / FWTM 31.0° / 53.0°</p> <p>Efficiency 73 %</p> <p>Peak intensity 2.2 cd/lm</p> <p>LEDs/each optic 1</p> <p>Light colour White</p> <p>Required components: Bender Wirth: 634c Hekla</p>		

#### OPTICAL RESULTS (MEASURED):



LED CDM-6 (Dim-To-Warm)  
 FWHM / FWTM 34.0° / 56.0°  
 Efficiency 63 %  
 Peak intensity 1.7 cd/m  
 LEDs/each optic 1  
 Light colour White  
 Required components:  
 C16142\_HEKLA-SOCKET-K  
 Bender Wirth: 490 Typ L8

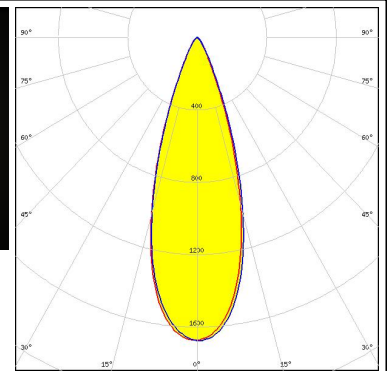
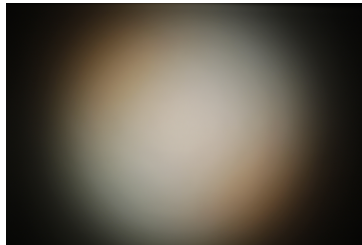

LED CDM-9 (Dim-To-Warm)  
 FWHM / FWTM 40.0° / 63.0°  
 Efficiency 61 %  
 Peak intensity 1.3 cd/m  
 LEDs/each optic 1  
 Light colour White  
 Required components:  
 C16142\_HEKLA-SOCKET-K  
 Bender Wirth: 490 Typ L8

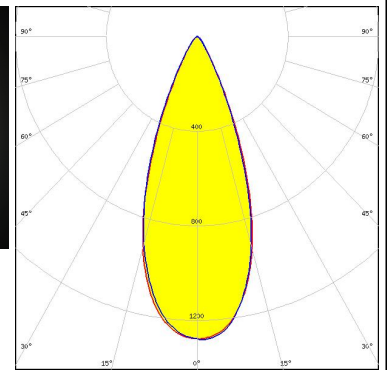
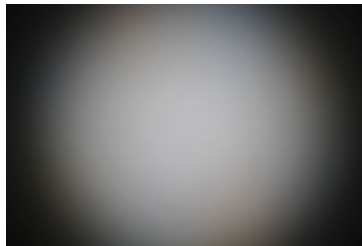

LED CXM-3  
 FWHM / FWTM 32.0° / 53.0°  
 Efficiency 83 %  
 Peak intensity 2.5 cd/m  
 LEDs/each optic 1  
 Light colour White  
 Required components:  
 F15255\_HEKLA-SOCKET-C

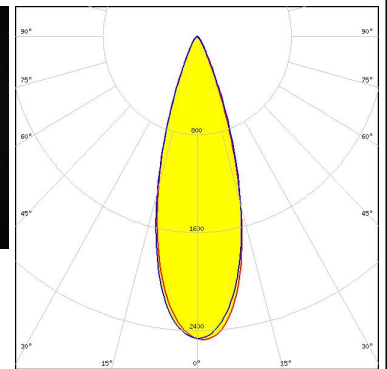
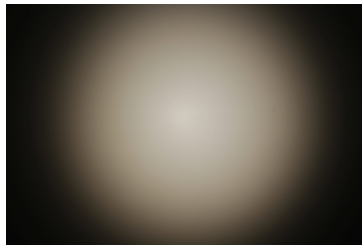

LED CXM-4  
 FWHM / FWTM 32.0° / 55.0°  
 Efficiency 79 %  
 Peak intensity 2.2 cd/m  
 LEDs/each optic 1  
 Light colour White  
 Required components:  
 F15255\_HEKLA-SOCKET-C

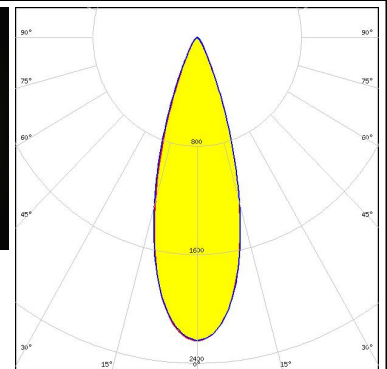
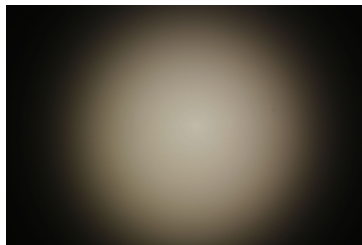

#### OPTICAL RESULTS (MEASURED):



LED CxM-9 (13.5x13.5)  
 FWHM / FWTM 46.0° / 71.0°  
 Efficiency 77 %  
 Peak intensity 1.3 cd/lm  
 LEDs/each optic 1  
 Light colour White  
 Required components:  
 F15255\_HEKLA-SOCKET-C

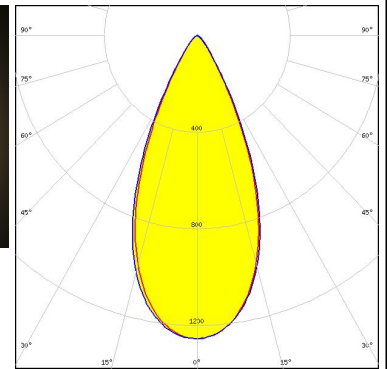

LED COB S-Type (LES 7)  
 FWHM / FWTM 39.0° / 64.0°  
 Efficiency 80 %  
 Peak intensity 1.7 cd/lm  
 LEDs/each optic 1  
 Light colour White  
 Required components:  
 F15848\_HEKLA-SOCKET-G

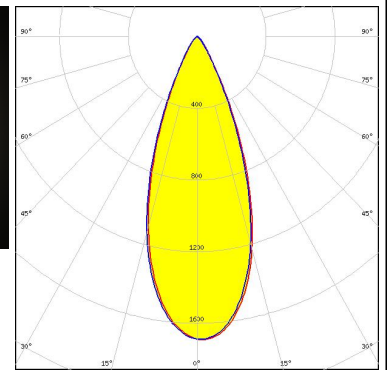
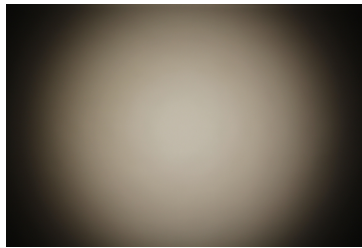

LED NJCWL024Z-V1MT: COB L-Type Tunable White  
 FWHM / FWTM 34.0° / 56.0°  
 Efficiency 62 %  
 Peak intensity 1.7 cd/lm  
 LEDs/each optic 1  
 Light colour White  
 Required components:  
 C16142\_HEKLA-SOCKET-K  
 Bender Wirth: 497 Typ L8

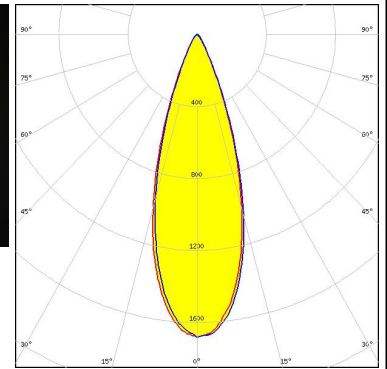
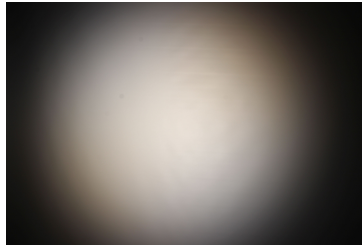

LED NVCWJ024Z-V1MT: COB J-Type Tunable White  
 FWHM / FWTM 42.0° / 67.0°  
 Efficiency 61 %  
 Peak intensity 1.1 cd/lm  
 LEDs/each optic 1  
 Light colour White  
 Required components:  
 C16142\_HEKLA-SOCKET-K  
 Bender Wirth: 498 Typ L8

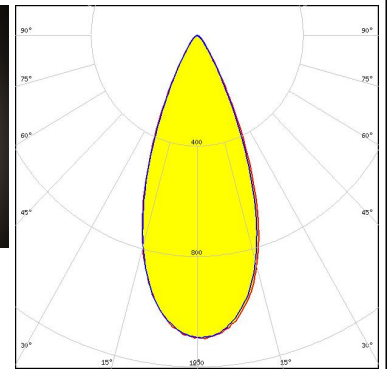
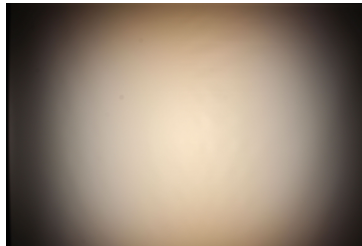



#### OPTICAL RESULTS (MEASURED):

### PHILIPS

LED Fortimo SLM L09 CoB  
 FWHM / FWTM 45.0° / 68.0°  
 Efficiency 76 %  
 Peak intensity 1.3 cd/lm  
 LEDs/each optic 1  
 Light colour White  
 Required components:  
 F15858\_HEKLA-SOCKET-H

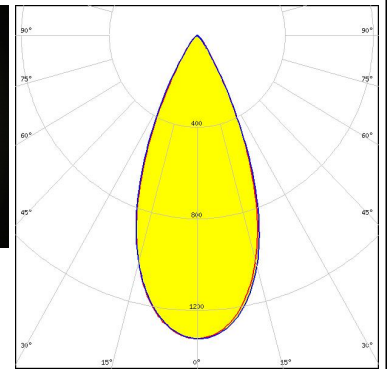

### SAMSUNG

LED LC003D / LC006D / LC009D / LC013D  
 FWHM / FWTM 47.0° / 73.0°  
 Efficiency 77 %  
 Peak intensity 1.2 cd/lm  
 LEDs/each optic 1  
 Light colour White  
 Required components:

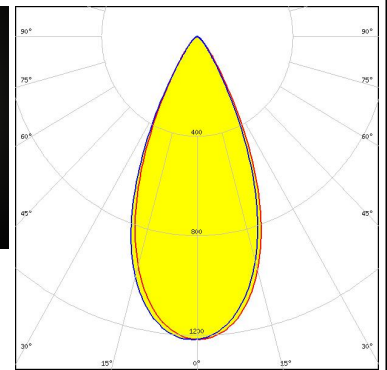

### SAMSUNG

LED LC010C G2  
 FWHM / FWTM 36.0° / 58.0°  
 Efficiency 80 %  
 Peak intensity 2 cd/lm  
 LEDs/each optic 1  
 Light colour White  
 Required components:  
 F15255\_HEKLA-SOCKET-C

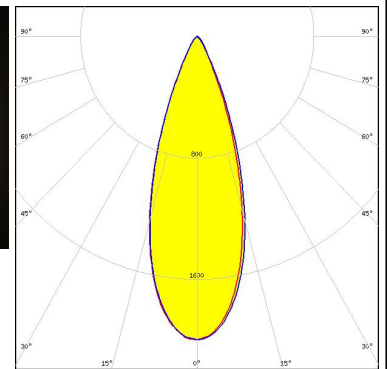
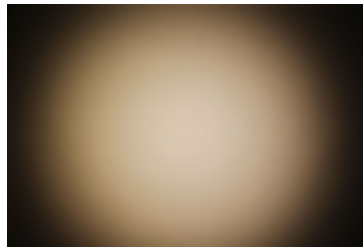

### SAMSUNG

LED LC010T (Tunable White)  
 FWHM / FWTM 39.0° / 64.0°  
 Efficiency 61 %  
 Peak intensity 1.3 cd/lm  
 LEDs/each optic 1  
 Light colour Tunable White  
 Required components:  
 C16142\_HEKLA-SOCKET-K  
 Bender Wirth: 501 Typ L8

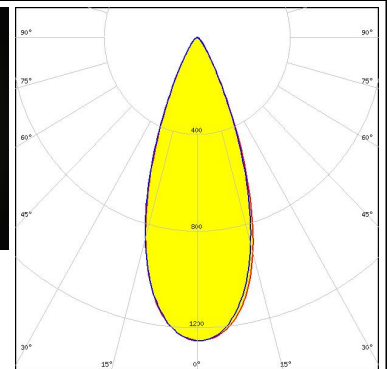
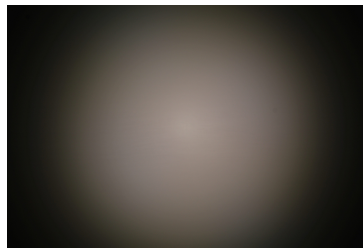

#### OPTICAL RESULTS (MEASURED):

### SAMSUNG

LED LC020C G2  
 FWHM / FWTM 43.0° / 67.0°  
 Efficiency 73 %  
 Peak intensity 1.4 cd/m  
 LEDs/each optic 1  
 Light colour White  
 Required components:  
 F15859\_HEKLA-SOCKET-I

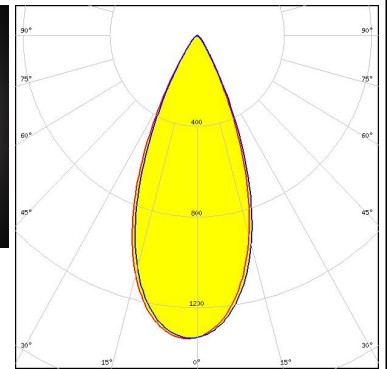
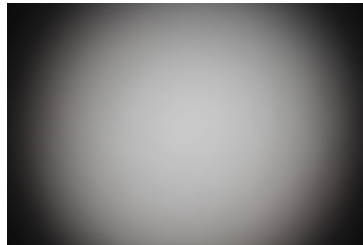

### TRIDONIC

LED SLE G7 LES09  
 FWHM / FWTM 44.0° / 69.0°  
 Efficiency 77 %  
 Peak intensity 1.4 cd/m  
 LEDs/each optic 1  
 Light colour White  
 Required components:  
 F15255\_HEKLA-SOCKET-C

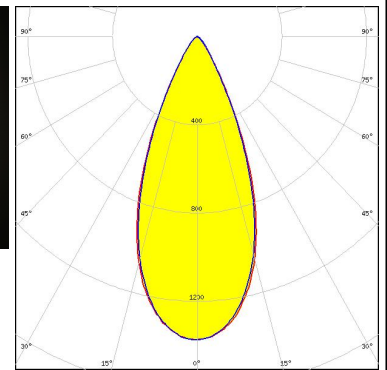
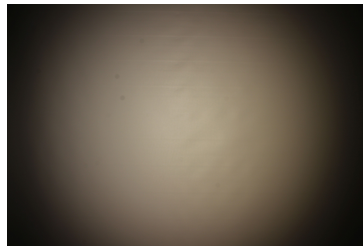

### TRIDONIC

LED SLE G7 LES13  
 FWHM / FWTM 57.0° / 82.0°  
 Efficiency 67 %  
 Peak intensity 0.8 cd/m  
 LEDs/each optic 1  
 Light colour White  
 Required components:  
 F15859\_HEKLA-SOCKET-I

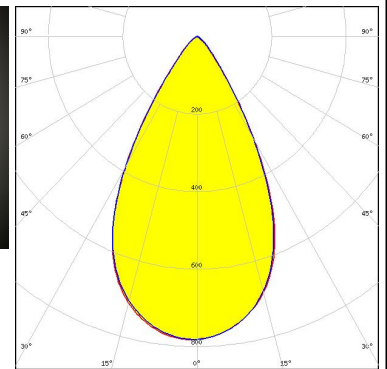
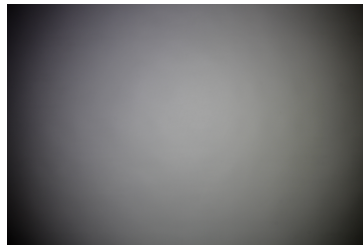

### XICATO

LED XOB 6 mm  
 FWHM / FWTM 36.0° / 59.0°  
 Efficiency 78 %  
 Peak intensity 1.9 cd/m  
 LEDs/each optic 1  
 Light colour White  
 Required components:  
 F15255\_HEKLA-SOCKET-C

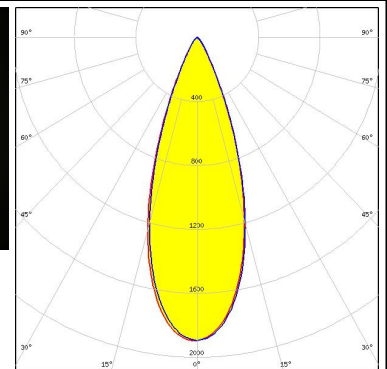
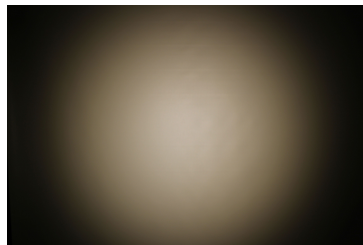

#### OPTICAL RESULTS (MEASURED):

#### XICATO

LED XOB 9.8 mm  
FWHM / FWTM 44.0° / 70.0°  
Efficiency 76 %  
Peak intensity 1.3 cd/lm  
LEDs/each optic 1  
Light colour White  
Required components:  
F15255\_HEKLA-SOCKET-C

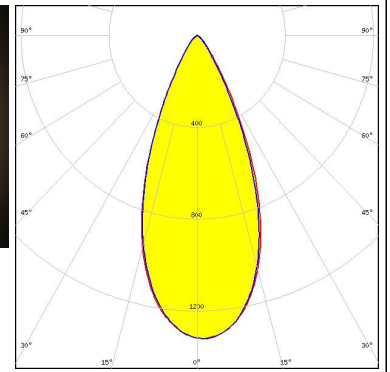

#### OPTICAL RESULTS (SIMULATED):

bridgelux.

LED V10 Gen7  
 FWHM / FWTM 44.0° / 66.0°  
 Efficiency 75 %  
 Peak intensity 1.4 cd/lm  
 LEDs/each optic 1  
 Light colour White  
 Required components:  
 F15255\_HEKLA-SOCKET-C

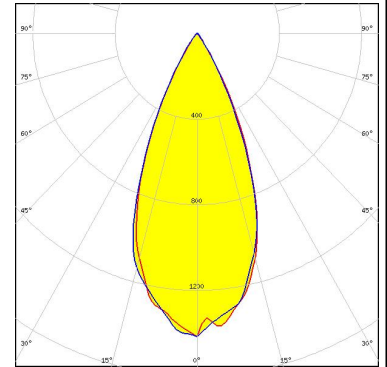

bridgelux.

LED V6 Gen6  
 FWHM / FWTM 29.0° / 48.0°  
 Efficiency 77 %  
 Peak intensity 3 cd/lm  
 LEDs/each optic 1  
 Light colour White  
 Required components:  
 F15253\_HEKLA-SOCKET-A

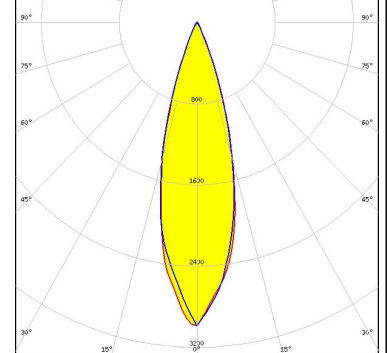

bridgelux.

LED V8 Gen7  
 FWHM / FWTM 40.0° / 62.0°  
 Efficiency 83 %  
 Peak intensity 1.8 cd/lm  
 LEDs/each optic 1  
 Light colour White  
 Required components:  
 F15253\_HEKLA-SOCKET-A

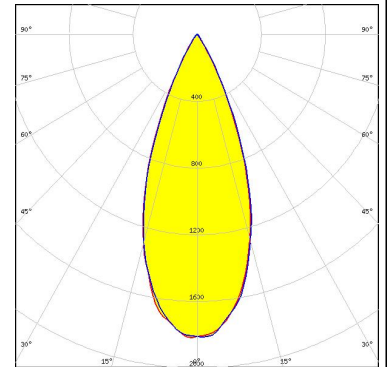

bridgelux.

LED VERO10  
 FWHM / FWTM 40.0° / 63.0°  
 Efficiency 74 %  
 Peak intensity 1.6 cd/lm  
 LEDs/each optic 1  
 Light colour White  
 Required components:  
 F15616\_HEKLA-SOCKET-F

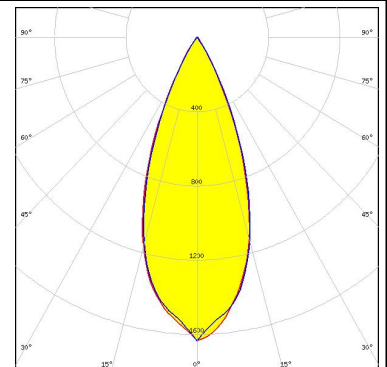

#### OPTICAL RESULTS (SIMULATED):



**LED** COB S-Type (LES 6)  
**FWHM / FWTM** 32.0° / 52.0°  
**Efficiency** 69 %  
**Peak intensity** 2.3 cd/lm  
**LEDs/each optic** 1  
**Light colour** White  
**Required components:**  
 F15848\_HEKLA-SOCKET-G

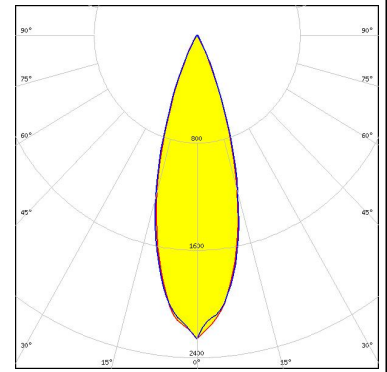

**LED** LC003D / LC006D / LC009D / LC013D  
**FWHM / FWTM** 46.0° / 67.0°  
**Efficiency** 71 %  
**Peak intensity** 1.3 cd/lm  
**LEDs/each optic** 1  
**Light colour** White  
**Required components:**  
 F17435\_HEKLA-G2-C

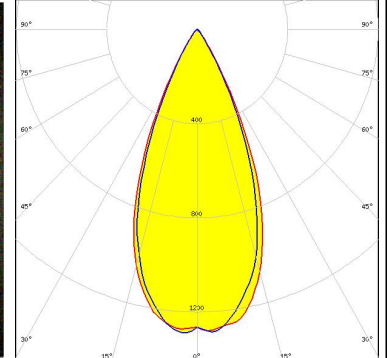

**LED** LC003D / LC006D / LC009D / LC013D  
**FWHM / FWTM** 44.0° / 66.0°  
**Efficiency** 71 %  
**Peak intensity** 1.3 cd/lm  
**LEDs/each optic** 1  
**Light colour** White  
**Required components:**  
 F17435\_HEKLA-G2-C

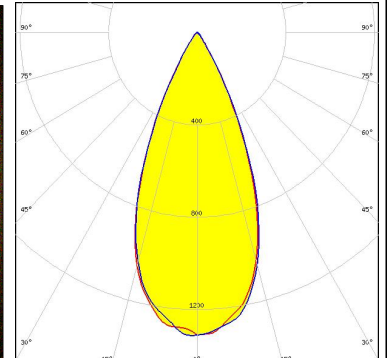

**LED** LC010C  
**FWHM / FWTM** 34.0° / 54.0°  
**Efficiency** 77 %  
**Peak intensity** 2.3 cd/lm  
**LEDs/each optic** 1  
**Light colour** White  
**Required components:**  
 F17435\_HEKLA-G2-C

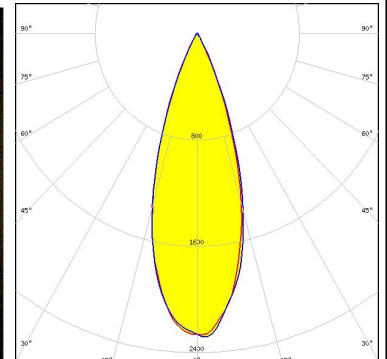
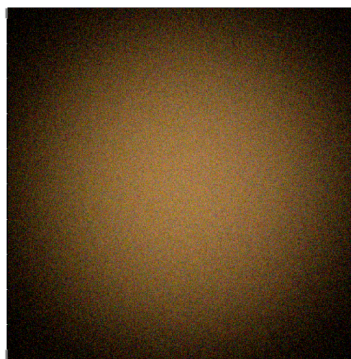



#### OPTICAL RESULTS (SIMULATED):

### SAMSUNG

LED LH231B  
FWHM / FWTM 41.0° / 65.0°  
Efficiency 73 %  
Peak intensity 1.5 cd/lm  
LEDs/each optic 7  
Light colour White  
Required components:  
F15255\_HEKLA-SOCKET-C

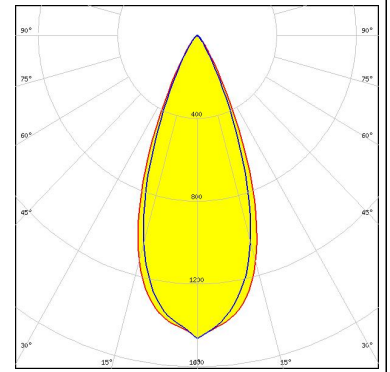

### XICATO

LED XTM - 9mm LES  
FWHM / FWTM 42.0° / 63.0°  
Efficiency 79 %  
Peak intensity 1.6 cd/lm  
LEDs/each optic 1  
Light colour White  
Required components:  
C15743\_XTM-ADAPTER-50-B

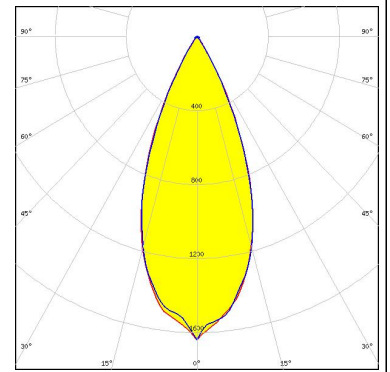

#### GENERAL INFORMATION:

NOTE: The typical beam angle will be changed by different color, chip size and chip position tolerance. The typical total beam angle is the full angle measured where the luminous intensity is half of the peak value.

Due to use of high power COB's with this product, special attention to proper thermal design is highly recommended. LEDiL has no liability for direct, indirect or consecutive damages arising from the LEDiL products being used outside of the recommended temperature range.

#### MATERIALS:

As part of our continuous research and improvement processes, and to ensure the best possible quality and availability of our products, LEDiL reserves the right to change material grades without notice.

#### PRODUCT DATA USER AGREEMENT AND DISCLAIMER:

The measured data in the provided downloadable LEDiL Product Datasheets and Mechanical 2D-Drawings is rounded and provided as reference for planning. LEDiL Oy's optical specifications have been verified by conducting performance testing of the products in accordance with the company's quality system. The reported data are averaged results of multiple measurements with typical variation. LEDiL Oy reserves the right to without prior notification make changes and improvements to its products.

LEDiL Oy assumes neither warranty, nor guarantee nor any other liability of any kind for the contents and correctness of the provided data. The provided data has been generated with highest diligence but the provided data may in reality not represent the complete possible variation range of all intrinsic parameters. Therefore, in certain cases a deviation from the provided data could occur.

LEDiL Oy reserves the right to undertake technical changes of its products without further notification which could lead to changes in the provided data. LEDiL Oy assumes no liability of any kind for the possible deviation from any provided data or any other damage resulting from the usage of the provided data.

The user agrees to this disclaimer and user agreement with the download or usage of the provided files.

#### LEDiL Oy

Joensuunkatu 13  
FI-24240 SALO  
Finland

#### LEDiL Inc.

228 West Page Street  
Suite D  
Sycamore IL 60178  
USA

#### Ledil Optics Technology (Shenzhen) Co., Ltd.

# 405 , Block B  
Casic Motor Building  
Shenzhen 518057  
P.R.CHINA

#### Local sales and technical support

[www.ledil.com/  
where\\_to\\_buy](http://www.ledil.com/where_to_buy)

#### Shipping locations

Salo, Finland  
Hong Kong, China

#### Distribution Partners

[www.ledil.com/  
where\\_to\\_buy](http://www.ledil.com/where_to_buy)