

High Density FFC/FPC Connector (0.3mm/0.4mm/0.5mm Pitch)

FH16 Series



FH16 Series Variation

0.3mm pitch 60 contact	
0.3mm pitch 80 contact	
0.4mm pitch 90 contact	
0.4mm pitch 80 contact	
0.5mm pitch 50 contact	
0.5mm pitch 64 contact	
[Conventional product (FH12 series)]	
0.5mm pitch 30 contact	

■ Features

1. High Density FFC/FPC Connector

The FH16 series is a fine pitch, zero insertion force (ZIF), right angle, bottom contact, connector compatible with flat flex cables (FFC) or flexible printed circuits (FPC) with a pitch of 0.3mm, 0.4mm, and 0.5mm and a recommended thickness of 0.295mm for single-sided or 0.306mm for double-sided. The FH16 provides a higher pin count given the same amount of board space than other manufacturers of similar product. With a large selection in pin density, the FH16 series greatly improves design flexibility.

FH16 : 0.3mm pitch 60, 80, and 90 contacts

FH16M : 0.4mm pitch 80 and 96 contacts

FH16H : 0.5mm pitch 50 contacts

FH16P : 0.5mm pitch 64 contacts

2. Easy mounting on PCB

FH16 supports 0.3mm pitch cable but only requires a 0.6mm pitch pad layout on the PCB. The FH16's staggered pin design allows the mounting lead area to be twice as wide as the FFC/FPC contact area making it easier to place the connector on the board given the fine pitch of the contacts.

3. User Friendly Flip-Lock Design

The flip-lock (one-touch rotating type) ZIF structure secures the FFC/FPC connection with a single and light force. This design helps simplify assembly and repair work. When locking the FFC/FPC, the audible click assures the assembly worker of a steady FFC/FPC connection resulting in improved customer service.

4. Prevents FFC/FPC from escape and oblique mating

The FH16 series with its recommended FFC/FPC dimensions prevents the FFC/FPC from escape and oblique mating thereby securing a steady connection.

5. Compatible with Automatic Assembly Tooling

Embossed tape packaging allows for automatic placement onto the PCB.

■ Applications

Notebook computers, printers, PDAs, digital cameras and other compact devices for interconnecting the main circuit board with the LCD, PDP (Plasma Display), HDD or other device.

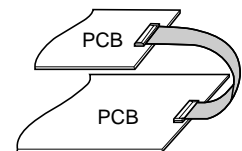
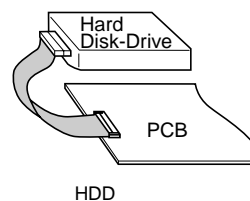
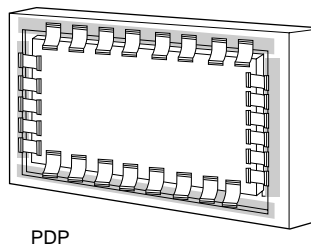
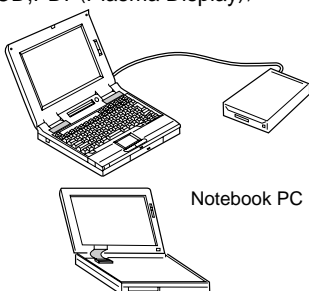

Excellent Serviceability with Flip-Lock Design

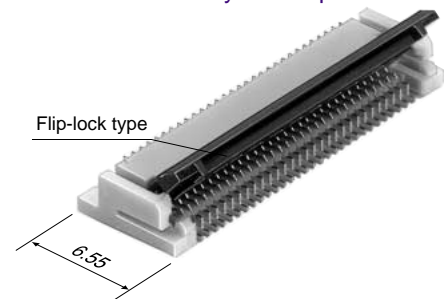

Mechanism to prevent FFC/FPC from escape and oblique mating

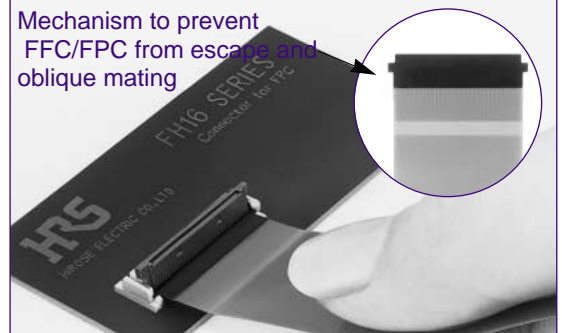

Product Specifications

Ratings	Pitch	0.3mm	0.4mm	0.5mm	Operating Temperature Range: -40°C to +70°C	Storage Temperature Range: -10°C to +50°C
	Current rating	0.15A	0.3A	0.4A		
	Voltage rating	30V AC	50V AC	60V AC		

Applicable cable $t=0.30 \pm 0.05$, solder plating (Note 3)

Item	Specification	Conditions
1. Insulation Resistance	500M ohms min.	100V DC
2. Withstanding Voltage	No flashover or insulation breakdown.	0.3mm pitch: 90V AC 0.4mm pitch: 150V AC applied for one minute 0.5mm pitch: 200V AC
3. Contact Resistance	150m ohms max. *Including FFC/FPC conductor resistance.	1mA
4. Durability (Insertion/withdrawal)	150m ohms max. No damage, cracks, or parts dislocation.	20 cycles
5. Vibration	No electrical discontinuity of 1 μ s or more Contact resistance: 150m ohms max. No damage, cracks, or parts dislocation.	Frequency: 10 to 55 Hz, single amplitude of 0.75 mm, 2 hours in each of the 3 directions.
6. Shock	No electrical discontinuity of 1 μ s or more Contact resistance: 150m ohms max. No damage, cracks, or parts dislocation.	Acceleration of 490 m/s ² , 11 ms duration, sine half-wave waveform, 3 cycles in each of the 3 axis.
7. Humidity (Steady state)	Contact resistance: 150m ohms max. Insulation resistance: 50M ohms max. No damage, cracks, or parts dislocation.	96 hours at temperature of 40°C and humidity of 90% to 95%
8. Temperature cycle	Contact resistance: 150m ohms max. Insulation resistance: 50M ohms min. No damage, cracks, or parts dislocation.	Temperature: -40 → +15 to 35°C → +85°C → +15°C to 35°C Time : 30 minutes → 5 minutes max. → 30 minutes → 5 minutes max. 5 cycles
9. Resistance to Soldering heat	No deformation of components affecting performance.	Reflow: At the recommended temperature profile Manual soldering: 350 \pm 5°C for 3 seconds

Note 1: Includes temperature rise caused by current flow.

Note 2: The term "storage" refers to products stored for long period of time prior to mounting and use. Operating Temperature Range and Humidity range covers nonconducting condition of installed connectors in storage, shipment or during transportation.

Note 3: When FPC is gold plated, the connector contacts should be also gold plated: Select the (05) specification.

Materials

Part	Material	Finish	Remarks
Insulator	Polyamide	Color : Beige	UL94V-0
	LCP		
	PPS	Color : Deep brown	
Contact	Phosphor bronze	Solder plating	—

Ordering Information

FH 16P - 64S - 0.5 SHW (05)

① ② ③ ④ ⑤ ⑥

① Series name	: FH
② Series No.	: 16, 16M, 16H, 16P
③ Number of contacts	: 50, 60, 64, 80, 90, and 96 contacts
④ Contact pitch	: 0.3mm, 0.4mm, 0.5mm
⑤ Terminal Shape	: SHW(SMT horizontal staggered row mount type)
⑥ Plating Specification	: No symbol : solder plating (05) : gold plating

◆ Connector Operation Method and Cautions

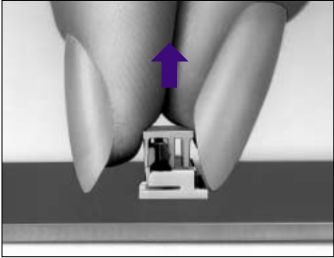
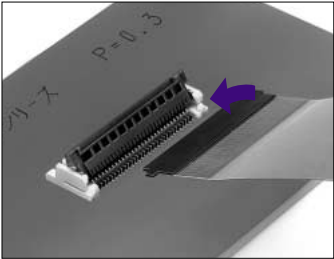
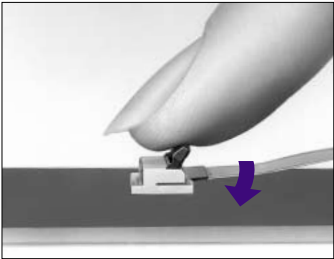
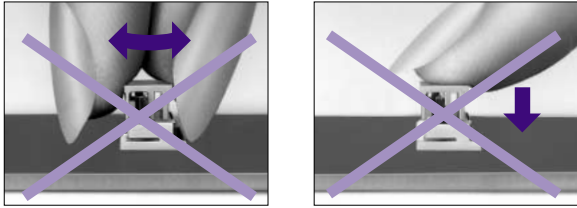
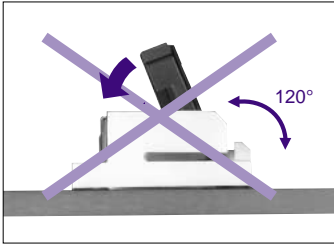
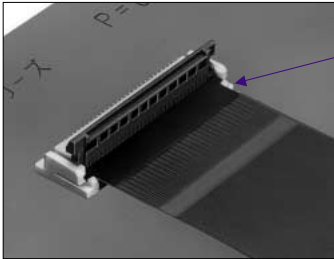
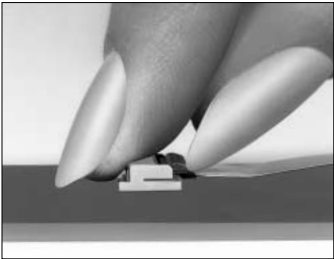
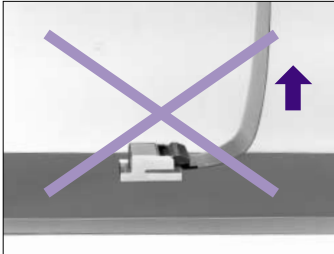
Operation Method	Precaution for Operation
<p>1. FFC/FPC Insertion Method</p> <p>A) Remove the suction cover so as to pick it up in the vertical direction.</p>  <p>B) Insert the FFC/FPC conductor surface upside down. Insert the FFC/FPC diagonally from above the connector until it firmly hooks on the positioning point. Slightly push the FFC/FPC, and check that it has been retained to the positioning point.</p>  <p>C) Push the lock lever down, by rotating the lever inward.</p> 	<p>A) When removing the suction cover, avoid any action that twist or pushes the cover. Such an action results in the removal of the flip-lock.</p>  <p>B) The FH16 Series is designed so that the flip-lock does not open more than about 120°. Do not use a force of 10N or greater to push it back any further. Doing so will cause the flip-lock to become disengaged or damaged.</p>  <p>C) Make certain to fully insert the FFC/FPC into the connector. Improper insertion causes the FFC/FPC to be disconnected, or conductivity failure.</p> 
<p>2. FFC/FPC Removal Method</p> <p>A) Release the locking lever by rotating it upwards. Then slightly raise the FFC/FPC and remove it.</p> 	<p>D) The connector structure does not have high tensile strength in the upper direction. If a tensile strength is applied to the FFC/FPC, be sure to fix the FFC/FPC for added support.</p> 

Connector Dimensions

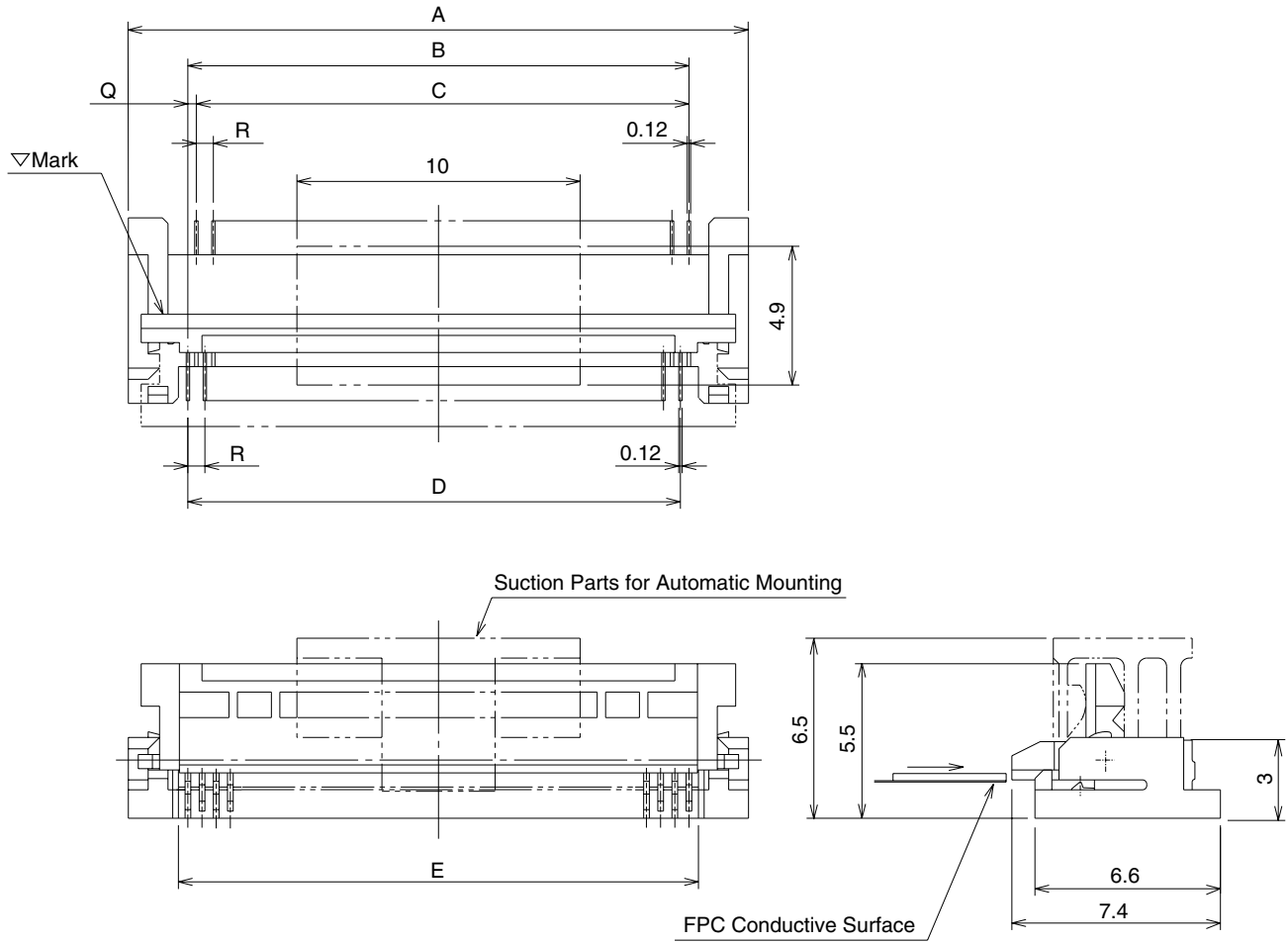

Unit: mm

Part Number	CL No.	Number of contacts	FFC/FPC Contact Pitch	A	B	C	D	E	Q	R
FH16-60S-0.3SHW	586-0620-2	60	0.3	21.9	17.7	17.4	17.4	18.35	0.3	0.6
FH16-80S-0.3SHW	586-0613-7	80	0.3	27.9	23.7	23.4	23.4	24.35	0.3	0.6
FH16-90S-0.3SHW	586-0697-7	90	0.3	30.9	26.7	26.4	26.4	27.35	0.3	0.6
FH16M-80S-0.4SHW	586-0675-4	80	0.4	36.1	31.6	31.2	31.2	32.25	0.4	0.8
FH16M-96S-0.4SHW	586-0715-7	96	0.4	42.5	38	37.6	37.6	38.65	0.4	0.8
FH16H-50S-0.5SHW	586-0676-7	50	0.5	29.4	24.5	24	24	25.55	0.5	1
FH16P-64S-0.5SHW	586-0649-4	64	0.5	36	31.5	31	31	32.15	0.5	1

NOTE: Products are packaged in embossed tape.

Order the product by the number of reels (1,000 pieces package per reel)

◆ Recommended PCB layout and metal mask dimensions

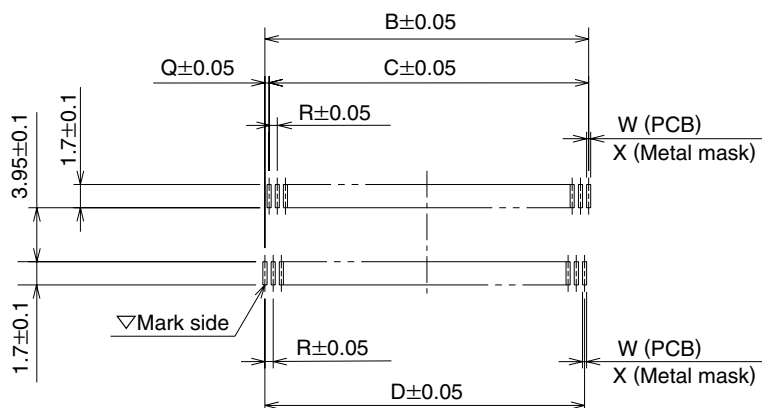

* Recommended metal mask thickness: $t=0.15$

◆ FFC/FPC recommended dimensions

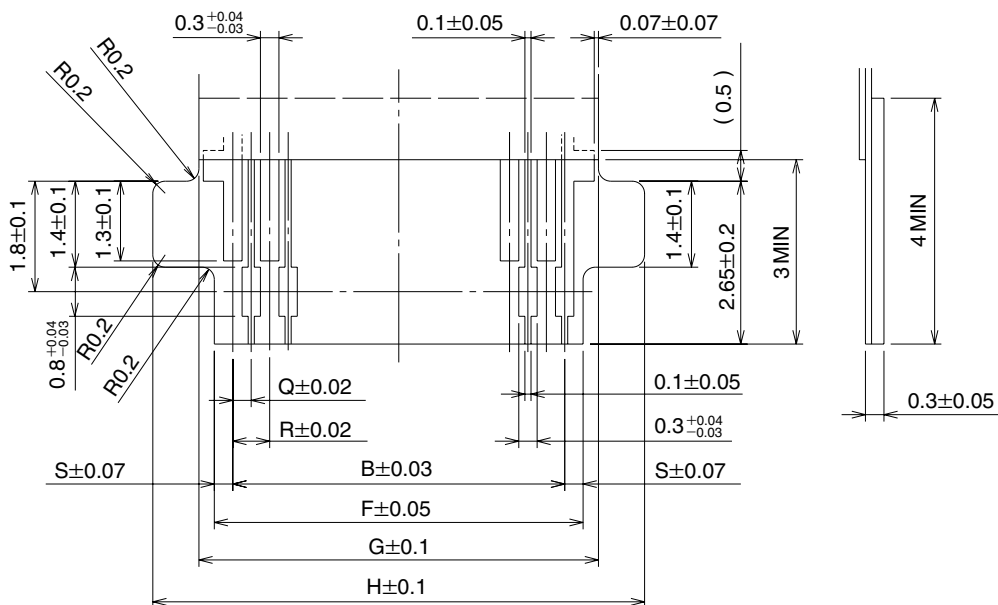

* Forced film material shall be polyamide + thermal hardened additives.

FFC, Land, Metal Mask Dimension Table

Unit: mm

Part Number	CL No.	Number of contacts	FFC/FPC Contact Pitch	B	C	D	F	G	H	Q	R	S	W	X
FH16-60S-0.3SHW	586-0620-2	60	0.3	17.7	17.4	17.4	18.3	18.8	20.3	0.3	0.6	0.3	0.3±0.03	0.25±0.03
FH16-80S-0.3SHW	586-0613-7	80	0.3	23.7	23.4	23.4	24.3	24.8	26.3	0.3	0.6	0.3	0.3±0.03	0.25±0.03
FH16-90S-0.3SHW	586-0697-7	90	0.3	26.7	26.4	26.4	27.3	27.8	29.3	0.3	0.6	0.3	0.3±0.03	0.25±0.03
FH16M-80S-0.4SHW	586-0675-4	80	0.4	31.6	31.2	31.2	32.2	32.7	34.2	0.4	0.8	0.3	0.3±0.03	0.25±0.03
FH16M-96S-0.5SHW	586-0715-7	96	0.4	38	37.6	37.6	38.6	39.1	40.6	0.4	0.8	0.3	0.3±0.03	0.25±0.03
FH16H-50S-0.5SHW	586-0676-7	50	0.5	24.5	24	24	25.5	25.5	27.5	0.5	1	0.5	0.6±0.1	0.5±0.05
FH16P-64S-0.5SHW	586-0649-4	64	0.5	31.5	31	31	32.1	32.6	34.1	0.5	1	0.3	0.6±0.1	0.5±0.05

◆ Packaging Specification

● Embossed Carrier Tape Dimensions

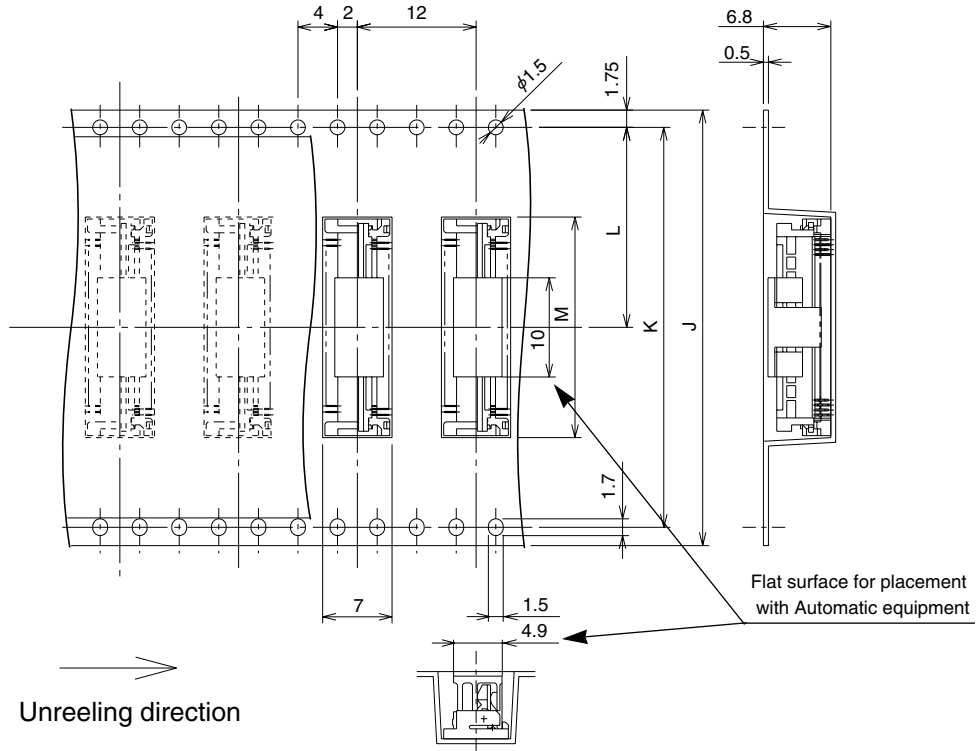

Unit: mm

Inserted Connector	Number of Contacts	J	K	L	M	T
FH16-60S-0.3SHW	60	44	40.4	20.2	22.3	44.5
FH16-80S-0.3SHW	80	44	40.4	20.2	28.3	44.5
FH16-90S-0.3SHW	90	44	40.4	20.2	31.3	44.5
FH16M-80S-0.4SHW	80	56	52.4	26.2	36.6	56.5
FH16M-96S-0.4SHW	96	56	52.4	26.2	43	56.5
FH16H-50S-0.5SHW	50	44	40.4	20.2	29.9	44.5
FH16P-64S-0.5SHW	64	56	52.4	26.2	36.6	56.5

NOTE: Standard package is 1,000 pieces per reel.

● Reel Dimensions

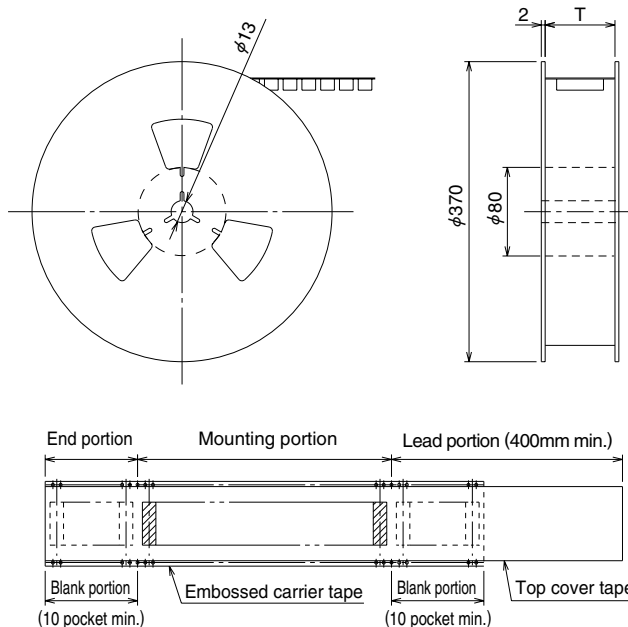

◆ Recommended Temperature Profile

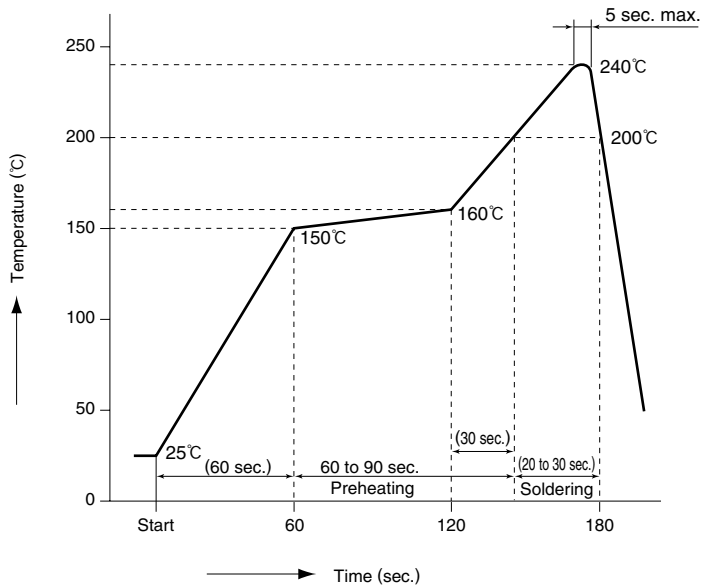

Applicable Condition

Recommended Conditions

Reflow system : IR reflow

Solder : Paste type 63Sn/37Pb
(Flux content 11 wt%)

Test board : Glass epoxy 40 x 80 x 1.6mm

Metal mask thickness : 0.15 mm

This temperature profile is a recommendation.

The temperature may be slightly changed according to the solder paste type and amount.

◆FH16 Series FPC Construction (Recommended Specifications)

1. Using Single-Sided FPC

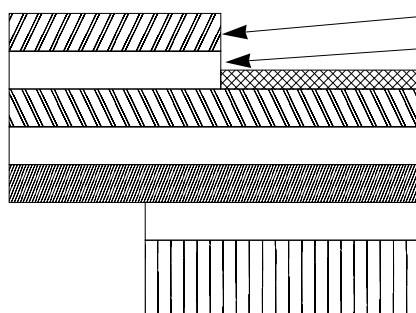

Material Name	Material	Thickness (μm)
Covering layer film	Polyamide 1 mil	25
Cover adhesive		25
Surface treatment	Solder plating	5
Copper foil	Cu 1oz	35
Base adhesive		25
Base film	Polyamide 1 mil	25
Reinforcement material adhesive	Heat-hardened adhesive	30
Stiffener	Polyamide 7 mil	175
Total		295

2. Using Double-Sided FPC

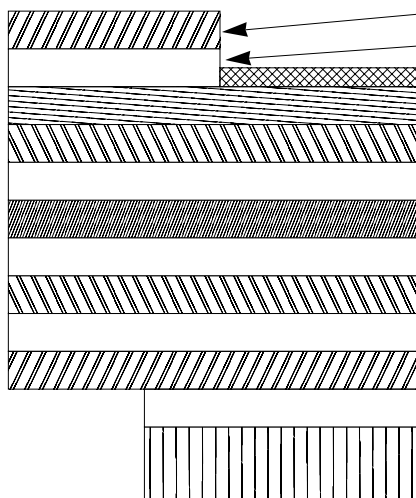

Material Name	Material	Thickness (μm)
Covering layer film	Polyamide 1 mil	25
Cover adhesive		25
Surface treatment	Solder plating	5
Through hole copper	Cu	15
Copper foil	Cu 1/2 oz	18
Base adhesive		18
Base film	Polyamide 1 mil	25
Base adhesive		18
Copper foil	Cu 1/2 oz	18
Cover adhesive		25
Cover layer film	Polyamide 1 mil	25
Reinforcement material adhesive	Heat-hardened adhesive	50
Stiffener	Polyamide 1 mil	100
Total		299

Note : Stiffener is not required for the double-sided.

To prevent release of the lock due to FPC bending, please do not use copper foil on the rear side.

3. Precautions

1. This specification is a recommendation for the construction of the FH16 Series FPC ($t=0.3 \pm 0.05$).
2. The FH16 Series are connectors for thin FPC which is beginning to be used in cameras and other miniature equipment.
Stiffener is not required for double-sided FPC which will be reflected in FPC cost reduction.
Please note that in the case of single-sided FPC, stiffener is required, but the thickness dimension can be created easily.
For details about the construction, please contact the FPC/FFC manufacturer.

FPC/FFC Manufactures' Contact List

Sumitomo Bakelite Co., Ltd. Flexible Printed Circuit Board Division 5-8, Higashi-shinagawa 2-chome, Shinagawa-ku, Tokyo, Japan	TEL:+81 3 5462 4191 FAX:+81 3 5462 4882
Fujikura Ltd. Electronics Global Marketing Department 1-5-1, Kiba, Koto-ku, Tokyo, Japan	TEL:+81 3 5606 1165 FAX:+81 3 5606 1530
NOK Corporation Sales Division Overseas Business Department 1-12-15, Shiba-Daimon, Minato-ku, Tokyo, Japan	TEL:+81 3 3432 6976/8415 FAX:+81 3 3432 3919