

Data sheet | Item number: 286-794

Optocoupler module; Nominal input voltage: 24 VDC; Red status indicator;  
gray



[www.wago.com/286-794](http://www.wago.com/286-794)



Color: —

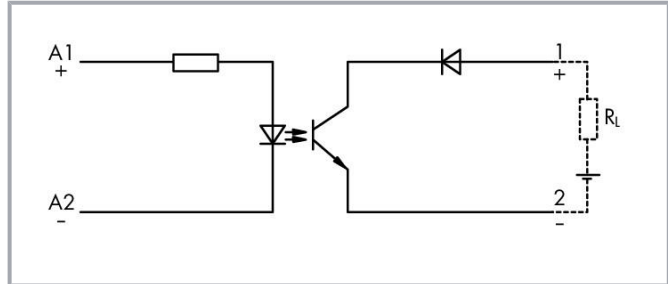

Subject to changes. Please also observe the further product documentation!

WAGO GmbH & Co. KG  
Hansastr. 27  
32423 Minden  
Phone: +49571 887-0 | Fax: +49571 887-169  
Email: [info.de@wago.com](mailto:info.de@wago.com) | Web: [www.wago.com](http://www.wago.com)

Do you have any questions about our products?  
We are always happy to take your call at +49 (571) 887-44222.

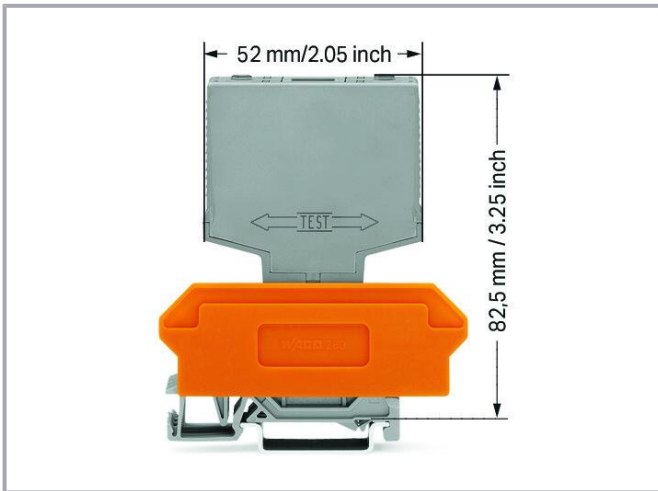

## Data

### Technical data

#### Control Circuit

Nominal input voltage $U_N$	DC 24 V
Input voltage range (high level)	DC 18 ... 30 V
Nominal input current at $U_N$	4 mA

#### Load circuit

Circuit type	2-wire connection
Limiting continuous current	0.1 A
Output voltage range	DC 20 ... 60 V
Voltage drop at output (max.)	$\leq$ DC 2 V
Leakage current at rated voltage	$\leq$ 2 $\mu$ A
Turn-on time	$\leq$ 80 $\mu$ s
Turn-off time	$\leq$ 100 $\mu$ s
Switching frequency	$\leq$ 1.5 kHz

#### Safety and protection

Pollution degree	2
Dielectric strength (control/load circuit) (AC, 1 min)	2.5 kVrms
Protection type	IP20

Subject to changes. Please also observe the further product documentation!



## Physical data

Width	10 mm / 0.394 inches
Height from upper-edge of DIN-rail	82.5 mm / 3.25 inches
Depth	52 mm / 2.047 inches

## Mechanical data

Mounting type	Pluggable module for receptacle terminal blocks
---------------	---

## Material Data

Color	gray
Fire load	7.69 MJ
Weight	16.3 g

## Environmental requirements

Ambient temperature (operation at $U_N$ )	-25 ... +60 °C
Ambient temperature (storage)	-25 ... +40 °C
Processing temperature	-25 ... +50 °C
Relative humidity	5 ... 95 % (no condensation permissible)
Operating altitude (max.)	2000 m

## Standards and specifications

Standards/specifications	EN 60664-1
--------------------------	------------

## Commercial data

Product Group	6 (INTERFACE ELECTRONIC)
eCl@ss 10.0	27-26-15-03
eCl@ss 9.0	27-26-15-03
ETIM 8.0	EC001504
ETIM 7.0	EC001504
PU (SPU)	25 (1) pcs
Packaging type	Box
Country of origin	DE
GTIN	4045454586218
Customs tariff number	85365005000

Subject to changes. Please also observe the further product documentation!

## Environmental Product Compliance

RoHS Compliance Status

Compliant, No Exemption

## Approvals / Certificates



### General approvals

Logo	Approval	Additional Approval Text	Certificate name
	EAC Brjansker Zertifizierungsstelle	TP TC 020/2011	EAC_Certificate_RU_C-DE.AM02.B.00115_19

## Optional accessories

### Terminal blocks

Terminal block for pluggable modules

	<b>Item no.: 280-608</b> Terminal block for pluggable modules; 4-pole; with 4-conductor terminal blocks; with orange separator; <a href="http://www.wago.com/280-608">www.wago.com/280-608</a> for DIN-rail 35 x 15 and 35 x 7.5; 2.5 mm <sup>2</sup> ; CAGE CLAMP®; 2,50 mm <sup>2</sup> ; gray	
	<b>Item no.: 280-618</b> Terminal block for pluggable modules; 4-pole; with 2-conductor terminal blocks; with orange separator; <a href="http://www.wago.com/280-618">www.wago.com/280-618</a> for DIN-rail 35 x 15 and 35 x 7.5; 2.5 mm <sup>2</sup> ; CAGE CLAMP®; 2,50 mm <sup>2</sup> ; gray	
	<b>Item no.: 280-762</b> Terminal block for pluggable modules; 4-pole; with 4-conductor terminal blocks; with marker carrier; <a href="http://www.wago.com/280-762">www.wago.com/280-762</a> with orange separator; for DIN-rail 35 x 15 and 35 x 7.5; 2.5 mm <sup>2</sup> ; CAGE CLAMP®; 2,50 mm <sup>2</sup> ; gray	

### Marking accessories

Marker

	<b>Item no.: 209-701</b> WSB marking card; as card; not stretchable; plain; snap-on type; white	<a href="http://www.wago.com/209-701">www.wago.com/209-701</a>
--	--	--

## Downloads

### Documentation

#### Bid Text

286-794 docx - Datei	2019 Feb 20	docx 15.7 kB	Download
286-794 X81 - Datei	2019 Feb 19	xml 3.8 kB	Download

### Instruction Leaflet

Subject to changes. Please also observe the further product documentation!

WAGO GmbH & Co. KG  
Hansastr. 27  
32423 Minden  
Phone: +49571 887-0 | Fax: +49571 887-169  
Email: [info.de@wago.com](mailto:info.de@wago.com) | Web: [www.wago.com](http://www.wago.com)

Do you have any questions about our products?  
We are always happy to take your call at +49 (571) 887-44222.

pdf  
1.3 MB

Download

### Additional Information

Disposal and Recycling V 1.1.0 pdf Download  
Electrical and electronic equipment, Batteries, Packaging 2022 Aug 18 2.2 MB

### CAD/CAE-Data

#### CAD data

2D/3D Models 286-794 URL Download

#### CAE data

WSCAD Universe 286-794 URL Download

ZUKEN Portal 286-794 URL Download

### Environmental Product Compliance

#### Compliance Search

Environmental Product Compliance 286-794 URL Download  
Optocoupler module; Nominal input voltage: 24 VDC; Red status indicator; gray

### Installation Notes

#### Installation

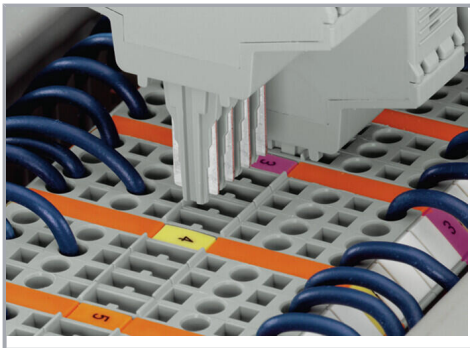

Coding ensures correct polarity.

Subject to changes. Please also observe the further product documentation!

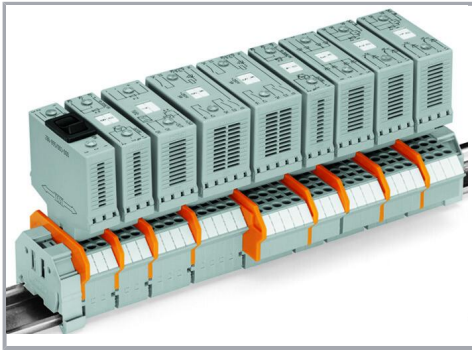

Pluggable electronic modules on 2- or 4-conductor carrier terminal blocks

### Marking

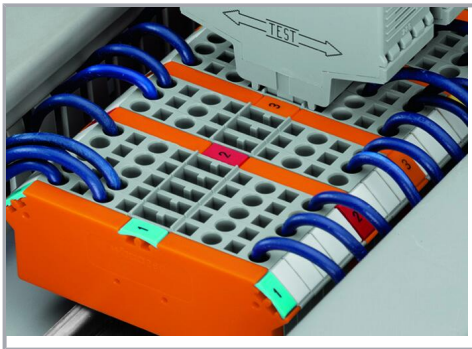

Marking via WMB Multi Marking System.

### Testing



Function testing via touch-proof test slots

Subject to changes. Please also observe the further product documentation!