

**NOT RECOMMENDED FOR NEW DESIGNS**  
Please See LTC2977 for Replacement

# 8-Channel PMBus Power System Manager Featuring Accurate Output Voltage Measurement

## FEATURES

- Sequence, Trim, Margin and Supervise Eight Power Supplies
- Manage Faults, Monitor Telemetry and Create Fault Logs
- PMBus Compliant Command Set
- Supported by LTpowerPlay® GUI
- Margin or Trim Supplies to 0.25% Accuracy
- Fast OV/UV Supervisors per Channel
- Coordinate Sequencing and Fault Management Across Multiple Chips
- Automatic Fault Logging to Internal EEPROM
- Operate Autonomously without Additional Software
- Internal Temperature and Input Voltage Supervisors
- Accurate Monitoring of Eight Output Voltages, Input Voltage and Internal Die Temperature
- I<sup>2</sup>C/SMBus Serial Interface
- Can Be Powered from 3.3V, or 4.5V to 15V
- Programmable Watchdog Timer
- 100% Compatible with the LTC2978
- Available in 64-pin 9mm × 9mm QFN Package

## APPLICATIONS

- Computers and Network Servers
- Industrial Test and Measurement
- High Reliability Systems
- Medical Imaging
- Video

## DESCRIPTION

The LTC<sup>®</sup>2978A is an 8-channel Power System Manager used to sequence, trim (servo), margin, supervise, manage faults, provide telemetry and create fault logs. PMBus commands support power supply sequencing, precision point-of-load voltage adjustment and margining. DACs use a proprietary soft-connect algorithm to minimize supply disturbances. Supervisory functions include overvoltage and undervoltage threshold limits for eight power supply output channels and one power supply input channel, as well as over and under temperature limits. Programmable fault responses can disable the power supplies with optional retry after a fault is detected. Faults that disable a power supply can automatically trigger black box EEPROM storage of fault status and associated telemetry. An internal 16-bit ADC monitors eight output voltages, one input voltage, and die temperature. In addition, odd numbered channels can be configured to measure the voltage across a current sense resistor. A programmable watchdog timer monitors microprocessor activity for a stalled condition and resets the microprocessor if necessary. A single wire bus synchronizes power supplies across multiple ADI power system management devices. Configuration EEPROM supports autonomous operation without additional software.

All registered trademarks and trademarks are the property of their respective owners. Protected by U.S. Patents including 7382303, 7420359 and 7940091.

## TYPICAL APPLICATION

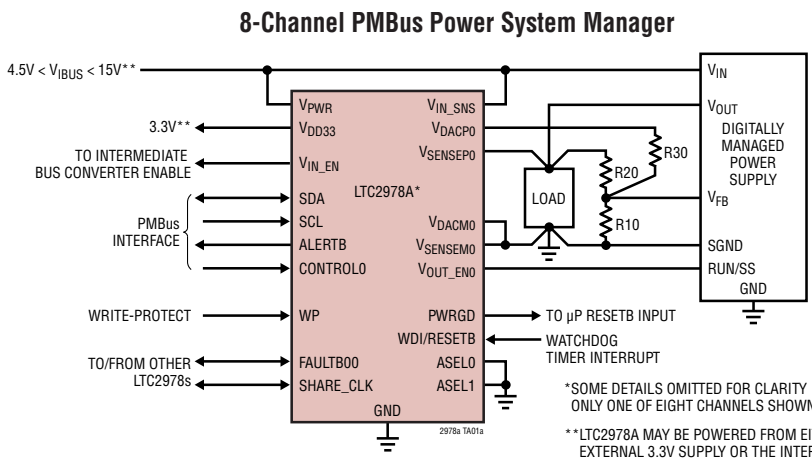

Typical ADC Total Unadjusted Error vs Temperature

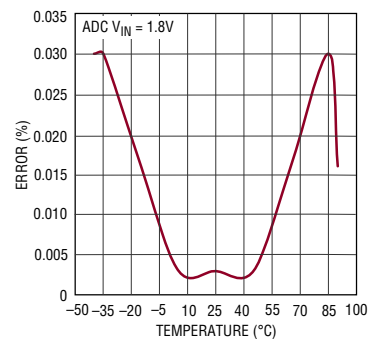

## TABLE OF CONTENTS

<b>Features</b> .....	<b>1</b>	Input Voltage Related Commands.....	34
<b>Applications</b> .....	<b>1</b>	VIN_ON, VIN_OFF, VIN_OV_FAULT_LIMIT, VIN_	
<b>Typical Application</b> .....	<b>1</b>	OV_WARN_LIMIT, VIN_UV_WARN_LIMIT and	
<b>Description</b> .....	<b>1</b>	VIN_UV_FAULT_LIMIT .....	34
<b>Absolute Maximum Ratings</b> .....	<b>4</b>	Temperature Related Commands.....	35
<b>Order Information</b> .....	<b>4</b>	OT_FAULT_LIMIT, OT_WARN_LIMIT, UT_WARN_	
<b>Pin Configuration</b> .....	<b>4</b>	LIMIT and UT_FAULT_LIMIT.....	35
<b>Electrical Characteristics</b> .....	<b>5</b>	Timer Limits .....	35
<b>PMBus Timing Diagram</b> .....	<b>9</b>	TON_DELAY, TON_RISE, TON_MAX_FAULT_	
<b>Typical Performance Characteristics</b> .....	<b>10</b>	LIMIT and TOFF_DELAY.....	35
<b>Pin Functions</b> .....	<b>15</b>	Fault Response for Voltages Measured by the High	
<b>Block Diagram</b> .....	<b>17</b>	Speed Supervisor .....	36
<b>Operation</b> .....	<b>18</b>	VOUT_OV_FAULT_RESPONSE and VOUT_UV_	
Operation Overview .....	18	FAULT_RESPONSE .....	36
EEPROM .....	18	Fault Response for Values Measured by the ADC ...	37
Reset .....	19	OT_FAULT_RESPONSE, UT_FAULT_RESPONSE,	
Write-Protect Pin .....	19	VIN_OV_FAULT_RESPONSE and VIN_UV_FAULT_	
Other Operations .....	19	RESPONSE .....	37
Clock Sharing .....	19	Timed Fault Response .....	37
PMBus Serial Digital Interface .....	20	TON_MAX_FAULT_RESPONSE .....	37
PMBus.....	20	Status Commands .....	38
Device Address.....	23	STATUS_BYTE.....	38
Processing Commands.....	24	STATUS_WORD.....	39
Summary Table.....	25	STATUS_VOUT .....	39
<b>PMBus Command Summary</b> .....	<b>25</b>	STATUS_INPUT .....	40
Data Formats .....	29	STATUS_TEMPERATURE.....	40
<b>PMBus Command Description</b> .....	<b>30</b>	STATUS_CML.....	41
Operation, Mode and EEPROM Commands .....	30	STATUS_MFR_SPECIFIC .....	41
PAGE .....	30	ADC Monitoring Commands .....	42
OPERATION .....	31	READ_VIN .....	42
ON_OFF_CONFIG .....	32	READ_VOUT .....	42
CLEAR_FAULTS.....	32	READ_TEMPERATURE_1 .....	42
WRITE_PROTECT.....	33	PMBUS_REVISION .....	42
STORE_USER_ALL and RESTORE_USER_ALL .....	33	Manufacturer Specific Commands.....	43
CAPABILITY.....	33	MFR_CONFIG_LTC2978 .....	43
VOUT_MODE .....	34	MFR_CONFIG_ALL_LTC2978 .....	44
Output Voltage Related Commands .....	34	MFR_FAULTBz0_PROPAGATE, MFR_FAULTBz1_	
VOUT_COMMAND, VOUT_MAX, VOUT_MARGIN_		PROPAGATE .....	45
HIGH, VOUT_MARGIN_LOW, VOUT_OV_FAULT_		MFR_PWRGD_EN .....	46
LIMIT, VOUT_OV_WARN_LIMIT, VOUT_UV_		MFR_FAULTB00_RESPONSE, MFR_FAULTB01_	
WARN_LIMIT, VOUT_UV_FAULT_LIMIT, POWER_		RESPONSE, MFR_FAULTB10_RESPONSE and	
GOOD_ON and POWER_GOOD_OFF .....	34	MFR_FAULTB11_RESPONSE.....	47

## TABLE OF CONTENTS

MFR_VINEN_OV_FAULT_RESPONSE .....	48	Off Sequencing .....	65
MFR_VINEN_UV_FAULT_RESPONSE .....	49	V <sub>OUT</sub> Off Threshold Voltage .....	65
MFR_RETRY_DELAY .....	49	Automatic Restart Via MFR_RESTART_DELAY Command and CONTROL <sub>n</sub> pin .....	66
MFR_RESTART_DELAY .....	50	Fault Management .....	66
MFR_VOUT_PEAK .....	50	Output Overvoltage and Undervoltage Faults .....	66
MFR_VIN_PEAK .....	50	Output Overvoltage and Undervoltage Warnings .....	66
MFR_TEMPERATURE_PEAK .....	50	Configuring the V <sub>IN_EN</sub> Output .....	66
MFR_DAC .....	51	Multichannel Fault Management .....	67
MFR_POWERGOOD_ASSERTION_DELAY .....	51	Interconnect Between Multiple LTC2978A's .....	69
Watchdog Operation .....	51	Application Circuits .....	70
MFR_WATCHDOG_T_FIRST and MFR_ WATCHDOG_T .....	51	Trimming and Margining DC/DC Converters with External Feedback Resistors .....	70
MFR_PAGE_FF_MASK .....	52	Four-Step Resistor Selection Procedure for DC/DC Converters with External Feedback Resistors .....	71
MFR_PADS .....	53	Trimming and Margining DC/DC Converters with a TRIM Pin .....	72
MFR_I2C_BASE_ADDRESS .....	53	Two-Step Resistor and DAC Full-Scale Voltage Selection Procedure for DC/DC Converters with a TRIM Pin .....	72
MFR_SPECIAL_ID .....	53	Measuring Current .....	72
MFR_SPECIAL_LOT .....	54	Measuring Current with a Sense Resistor .....	73
MFR_VOUT_DISCHARGE_THRESHOLD .....	54	Measuring Current with Inductor DCR .....	73
MFR_COMMON .....	54	Single Phase Design Example .....	74
MFR_SPARE_0, MFR_SPARE_1, MFR_SPARE_2, MFR_SPARE_3 .....	54	Measuring Multiphase Currents .....	74
MFR_VOUT_MIN .....	55	Multiphase Design Example .....	74
MFR_VIN_MIN .....	55	Anti-aliasing Filter Considerations .....	75
MFR_TEMPERATURE_MIN .....	55	Sensing Negative Voltages .....	75
Fault Log Operation .....	55	Connecting the DC1613 USB to I <sup>2</sup> C/SMBus/PMBus Controller to the LTC2978A in System .....	76
MFR_FAULT_LOG_STORE .....	56	LTpowerPlay: An Interactive GUI for Power System Managers .....	78
MFR_FAULT_LOG_RESTORE .....	56	PCB Assembly and Layout Suggestions .....	79
MFR_FAULT_LOG_CLEAR .....	56	Bypass Capacitor Placement .....	79
MFR_FAULT_LOG_STATUS .....	56	Exposed Pad Stencil Design .....	79
MFR_FAULT_LOG .....	57	PC Board Layout .....	79
<b>Applications Information .....</b>	<b>63</b>	Unused ADC Sense Inputs .....	79
Overview .....	63	<b>Package Description .....</b>	<b>80</b>
Powering the LTC2978A .....	63	<b>Revision History .....</b>	<b>81</b>
Setting Command Register Values .....	63	<b>Typical Application .....</b>	<b>82</b>
Sequence, Servo, Margin and Restart Operations ..	63	<b>Related Parts .....</b>	<b>82</b>
Command Units On or Off .....	63		
On Sequencing .....	64		
On State Operation .....	64		
Servo Modes .....	64		
DAC Modes .....	65		
Margining .....	65		

# LTC2978A

## ABSOLUTE MAXIMUM RATINGS

(Notes 1, 2)

Supply Voltages:

$V_{PWR}$ to GND .....	-0.3V to 15V
$V_{DD33}$ to GND .....	-0.3V to 3.6V
$V_{DD25}$ to GND .....	-0.3V to 2.75V

Digital Input/Output Voltages:

ALERTB, SDA, SCL, CONTROL0, CONTROL1 .....	-0.3V to 5.5V
PWRGD, SHARE_CLK, WDI/RESETB, WP .....	-0.3V to $V_{DD33} + 0.3V$
FAULTB00, FAULTB01, FAULTB10, FAULTB11 .....	-0.3V to $V_{DD33} + 0.3V$
ASEL0, ASEL1 .....	-0.3V to $V_{DD33} + 0.3V$

Analog Voltages:

REFP .....	-0.3V to 1.35V
REFM to GND .....	-0.3V to 0.3V
$V_{IN\_SNS}$ to GND .....	-0.3V to 15V
$V_{SENSEP[7:0]}$ to GND .....	-0.3V to 6V
$V_{SENSEM[7:0]}$ to GND .....	-0.3V to 6V
$V_{OUT\_EN[3:0]}$ , $V_{IN\_EN}$ to GND .....	-0.3V to 15V
$V_{OUT\_EN[7:4]}$ to GND .....	-0.3V to 6V
$V_{DACP[7:0]}$ to GND .....	-0.3V to 6V
$V_{DACM[7:0]}$ to GND .....	-0.3V to 0.3V

Operating Junction Temperature Range:

LTC2978AC .....	0°C to 70°C
LTC2978AI .....	-40°C to 85°C

Storage Temperature Range .....

Maximum Junction Temperature .....

\*See OPERATION section for detailed EEPROM de-rating information for junction temperatures in excess of 85°C.

## PIN CONFIGURATION

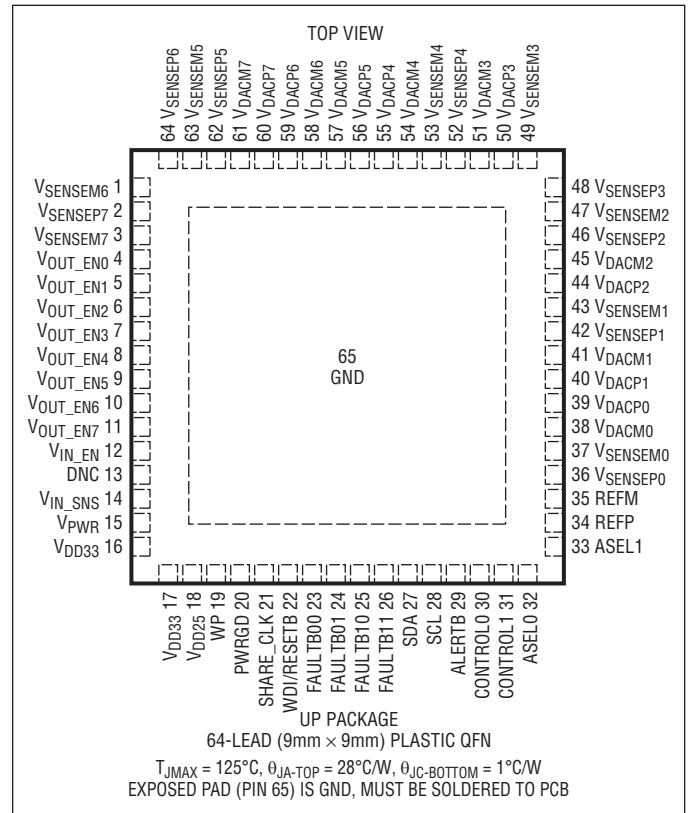

## ORDER INFORMATION <http://www.linear.com/product/LTC2978A#orderinfo>

LEAD FREE FINISH	TAPE AND REEL	PART MARKING*	PACKAGE DESCRIPTION	JUNCTION TEMPERATURE RANGE
LTC2978ACUP#PBF	LTC2978ACUP#TRPBF	LTC2978AUP	64-Lead (9mm x 9mm) Plastic QFN	0°C to 70°C
LTC2978AIUP#PBF	LTC2978AIUP#TRPBF	LTC2978AUP	64-Lead (9mm x 9mm) Plastic QFN	-40°C to 85°C

Consult ADI Marketing for parts specified with wider operating temperature ranges. \*The temperature grade is identified by a label on the shipping container.

For more information on lead free part marking, go to: <http://www.linear.com/leadfree/>

For more information on tape and reel specifications, go to: <http://www.linear.com/tapeandreeel/>. Some packages are available in 500 unit reels through designated sales channels with #TRMPBF suffix.

**ELECTRICAL CHARACTERISTICS** The ● denotes the specifications which apply over the full operating temperature range, otherwise specifications are at  $T_J = 25^\circ\text{C}$ .  $V_{PWR} = V_{IN\_SNS} = 12\text{V}$ ,  $V_{DD33}$ ,  $V_{DD25}$ , REFP and REFM pins floating, unless otherwise indicated.  $C_{VDD33} = 100\text{nF}$ ,  $C_{VDD25} = 100\text{nF}$  and  $C_{REF} = 100\text{nF}$ .

SYMBOL	PARAMETER	CONDITIONS	MIN	TYP	MAX	UNITS	
<b>Power-Supply Characteristics</b>							
$V_{PWR}$	$V_{PWR}$ Supply Input Operating Range		● 4.5		15	V	
$I_{PWR}$	$V_{PWR}$ Supply Current	$4.5\text{V} \leq V_{PWR} \leq 15\text{V}$ , $V_{DD33}$ Floating	●	10	13	mA	
$I_{VDD33}$	$V_{DD33}$ Supply Current	$3.13\text{V} \leq V_{DD33} \leq 3.47\text{V}$ , $V_{PWR} = V_{DD33}$	●	10	13	mA	
$V_{UVLO\_VDD33}$	$V_{DD33}$ Undervoltage Lockout	$V_{DD33}$ Ramping Up, $V_{PWR} = V_{DD33}$	●	2.35	2.55	2.8	V
	$V_{DD33}$ Undervoltage Lockout Hysteresis			120		mV	
$V_{DD33}$	Supply Input Operating Range	$V_{PWR} = V_{DD33}$	●	3.13		3.47	V
	Regulator Output Voltage	$4.5\text{V} \leq V_{PWR} \leq 15\text{V}$	●	3.13	3.26	3.47	V
	Regulator Output Short-Circuit Current	$V_{PWR} = 4.5\text{V}$ , $V_{DD33} = 0\text{V}$	●	75	90	140	mA
$V_{DD25}$	Regulator Output Voltage	$3.13\text{V} \leq V_{DD33} \leq 3.47\text{V}$	●	2.35	2.5	2.6	V
	Regulator Output Short-Circuit Current	$V_{PWR} = V_{DD33} = 3.47\text{V}$ , $V_{DD25} = 0\text{V}$	●	30	55	80	mA
$t_{INIT}$	Initialization Time	Time from $V_{IN}$ Applied Until the TON_DELAY Timer Starts		135		ms	
<b>Voltage Reference Characteristics</b>							
$V_{REF}$	Output Voltage	$V_{REF} = V_{REFP} - V_{REFM}$ , $0 < I_{REFP} < 100\mu\text{A}$		1.232		V	
	Temperature Coefficient			3		ppm/ $^\circ\text{C}$	
	Hysteresis	(Note 3)		100		ppm	
<b>ADC Characteristics</b>							
$V_{IN\_ADC}$	Voltage Sense Input Range	Differential Voltage: $V_{IN\_ADC} = (V_{SENSEPN} - V_{SENSEMN})$	●	0	6	V	
		Single-Ended Voltage: $V_{SENSEMN}$	●	-0.1	0.1	V	
	Current Sense Input Range (Odd Numbered Channels Only)	Single-Ended Voltage: $V_{SENSEPN}$ , $V_{SENSEMN}$	●	-0.1	6	V	
		Differential Voltage: $V_{IN\_ADC}$	●	-170	170	mV	
$N_{ADC}$	Voltage Sense Resolution (Uses L16 Format)	$0\text{V} \leq V_{IN\_ADC} \leq 6\text{V}$		122		$\mu\text{V}/\text{LSB}$	
	Current Sense Resolution (Odd Numbered Channels Only)	$0\text{mV} \leq  V_{IN\_ADC}  < 16\text{mV}$ (Note11)		15.625		$\mu\text{V}/\text{LSB}$	
		$16\text{mV} \leq  V_{IN\_ADC}  < 32\text{mV}$		31.25		$\mu\text{V}/\text{LSB}$	
$32\text{mV} \leq  V_{IN\_ADC}  < 63.9\text{mV}$			62.5		$\mu\text{V}/\text{LSB}$		
$TUE\_ADC\_VOLT\_SNS$	Total Unadjusted Error	Voltage Sense Mode $V_{IN\_ADC} \geq 1\text{V}$	●		$\pm 0.25$	% of Reading	
		Voltage Sense Mode $0 \leq V_{IN\_ADC} < 1\text{V}$	●		$\pm 2.5$	mV	
$TUE\_ADC\_CURR\_SNS$	Total Unadjusted Error	Current Sense Mode, Odd Numbered Channels Only, $20\text{mV} \leq V_{IN\_ADC} \leq 170\text{mV}$	●		$\pm 0.7$	% of Reading	
		Current Sense Mode, Odd Numbered Channels Only, $V_{IN\_ADC} \leq 20\text{mV}$	●		140	$\mu\text{V}$	
$V_{OS\_ADC}$	Offset Error	Current Sense Mode, Odd Numbered Channels Only	●		$\pm 35$	$\mu\text{V}$	
$t_{CONV\_ADC}$	Conversion Time	Voltage Sense Mode (Note 4)		6.15		ms	
		Current Sense Mode (Note 4)		24.6		ms	
		Temperature Input (Note 4)		24.6		ms	
$t_{UPDATE\_ADC}$	Maximum Update Time	Odd Numbered Channels in Current Sense Mode (Note 4)		160		ms	

## ELECTRICAL CHARACTERISTICS

The ● denotes the specifications which apply over the full operating temperature range, otherwise specifications are at  $T_J = 25^\circ\text{C}$ .  $V_{PWR} = V_{IN\_SNS} = 12\text{V}$ ;  $V_{DD33}$ ,  $V_{DD25}$ , REFP and REFM pins floating, unless otherwise indicated.  $C_{VDD33} = 100\text{nF}$ ,  $C_{VDD25} = 100\text{nF}$  and  $C_{REF} = 100\text{nF}$ .

SYMBOL	PARAMETER	CONDITIONS	MIN	TYP	MAX	UNITS
$C_{IN\_ADC}$	Input Sampling Capacitance			1		pF
$f_{IN\_ADC}$	Input Sampling Frequency			62.5		kHz
$I_{IN\_ADC}$	Input Leakage Current	$V_{IN\_ADC} = 0\text{V}$ , $0\text{V} \leq V_{COMMONMODE} \leq 6\text{V}$ , Current Sense Mode	●		±0.5	μA
	Differential Input Current	$V_{IN\_ADC} = 0.17\text{V}$ , Current Sense Mode	●	80	250	nA
		$V_{IN\_ADC} = 6\text{V}$ , Voltage Sense Mode	●	10	15	μA

### DAC Output Characteristics

$N_{VDACP}$	Resolution			10		Bits	
$V_{FS\_VDACP}$	Full-Scale Output Voltage (Programmable)	DAC Code = 0x3FF	●	1.32	1.38	1.44	V
		DAC Polarity = 1	●	2.53	2.65	2.77	V
$INL_{VDACP}$	Integral Nonlinearity	(Note 5)	●		±2	LSB	
$DNL_{VDACP}$	Differential Nonlinearity	(Note 5)	●		±2.4	LSB	
$V_{OS\_VDACP}$	Offset Voltage	(Note 5)	●		±10	mV	
$V_{DACP}$	Load Regulation ( $V_{DACPn} - V_{DACMn}$ )	$V_{DACPn} = 2.65\text{V}$ , $I_{VDACPn}$ Sourcing = 2mA		100		ppm/mA	
		$V_{DACPn} = 0.1\text{V}$ , $I_{VDACPn}$ Sinking = 2mA		100		ppm/mA	
	PSRR ( $V_{DACPn} - V_{DACMn}$ )	DC: $3.13\text{V} \leq V_{DD33} \leq 3.47\text{V}$ , $V_{PWR} = V_{DD33}$		60		dB	
		100mV Step in 20ns with 50pF Load		40		dB	
	DC CMRR ( $V_{DACPn} - V_{DACMn}$ )	$-0.1\text{V} \leq V_{DACMn} \leq 0.1\text{V}$		60		dB	
	Leakage Current	$V_{DACPn}$ Hi-Z, $0\text{V} \leq V_{DACPn} \leq 6\text{V}$	●			±100	nA
	Short-Circuit Current Low	$V_{DACPn}$ Shorted to GND	●	-10		-4	mA
Short-Circuit Current High	$V_{DACPn}$ Shorted to $V_{DD33}$	●	4		10	mA	
$C_{OUT}$	Output Capacitance	$V_{DACPn}$ Hi-Z		10		pF	
$t_{S\_VDACP}$	DAC Output Update Rate	Fast Servo Mode		250		μs	

### Voltage Supervisor Characteristics

$V_{IN\_VS}$	Input Voltage Range (Programmable)	$V_{IN\_VS} = (V_{SENSEp} - V_{SENSEMn})$	Low Resolution Mode	●	0	6	V
			High Resolution Mode	●	0	3.8	V
		Single-Ended Voltage: $V_{SENSEMn}$		●	-0.1	0.1	V
$N_{VS}$	Voltage Sensing Resolution	0V to 3.8V Range: High Resolution Mode		4		mV/LSB	
		0V to 6V Range: Low Resolution Mode		8		mV/LSB	
$TUE_{VS}$	Total Unadjusted Error	$2\text{V} \leq V_{IN\_VS} \leq 6\text{V}$ , Low Resolution Mode	●		±1.25	%	
		$1.5\text{V} < V_{IN\_VS} \leq 3.8\text{V}$ , High Resolution Mode	●		±1.0	%	
		$0.8\text{V} \leq V_{IN\_VS} \leq 1.5\text{V}$ , High Resolution Mode	●		±1.5	%	
$t_{S\_VS}$	Update Rate			12.21		μs	

### $V_{IN\_SNS}$ Input Characteristics

$V_{VIN\_SNS}$	$V_{IN\_SNS}$ Input Voltage Range		●	0	15	V	
$R_{VIN\_SNS}$	$V_{IN\_SNS}$ Input Resistance		●	70	90	110	kΩ
$TUE_{VIN\_SNS}$	VIN_ON, VIN_OFF Threshold Total Unadjusted Error	$3\text{V} \leq V_{VIN\_SNS} \leq 8\text{V}$	●		±2.0	%	
		$V_{VIN\_SNS} > 8\text{V}$	●		±1.0	%	
	READ_VIN Total Unadjusted Error	$3\text{V} \leq V_{VIN\_SNS} \leq 8\text{V}$	●		±1.5	%	
		$V_{VIN\_SNS} > 8\text{V}$	●		±1.0	%	



**ELECTRICAL CHARACTERISTICS** The ● denotes the specifications which apply over the full operating temperature range, otherwise specifications are at  $T_J = 25^\circ\text{C}$ .  $V_{PWR} = V_{IN\_SNS} = 12\text{V}$ ;  $V_{DD33}$ ,  $V_{DD25}$ , REFP and REFM pins floating, unless otherwise indicated.  $C_{VDD33} = 100\text{nF}$ ,  $C_{VDD25} = 100\text{nF}$  and  $C_{REF} = 100\text{nF}$ .

SYMBOL	PARAMETER	CONDITIONS	MIN	TYP	MAX	UNITS	
<b>DAC Soft-Connect Comparator Characteristics</b>							
$V_{OS\_CMP}$	Offset Voltage	$V_{DACPn} = 0.2\text{V}$	●	±1	±18	mV	
		$V_{DACPn} = 1.3\text{V}$	●	±2	±26	mV	
		$V_{DACPn} = 2.65\text{V}$	●	±3	±52	mV	
<b>Temperature Sensor Characteristics</b>							
TUE_TS	Total Unadjusted Error			±1		°C	
<b><math>V_{OUT\_ENn}</math> Enable Output (<math>V_{OUT\_EN}</math> [3:0]) Characteristics</b>							
$V_{VOUT\_ENn}$	Output High Voltage (Note 10)	$I_{VOUT\_ENn} = -5\mu\text{A}$ , $V_{DD33} = 3.3\text{V}$	●	10	12.5	14.7	V
$I_{VOUT\_ENn}$	Output Sourcing Current	$V_{VOUT\_ENn}$ Pull-Up Enabled, $V_{VOUT\_ENn} = 1\text{V}$	●	-5	-6	-8	$\mu\text{A}$
	Output Sinking Current	Strong Pull-Down Enabled, $V_{VOUT\_ENn} = 0.4\text{V}$	●	3	5	8	mA
		Weak Pull-Down Enabled, $V_{VOUT\_ENn} = 0.4\text{V}$	●	33	50	60	$\mu\text{A}$
	Output Leakage Current	Internal Pull-Up Disabled, $0\text{V} \leq V_{VOUT\_ENn} \leq 15\text{V}$	●		±1	$\mu\text{A}$	
<b><math>V_{OUT\_ENn}</math> Enable Output (<math>V_{OUT\_EN}</math> [7:4]) Characteristics</b>							
$I_{VOUT\_ENn}$	Output Sinking Current	Strong Pull-Down Enabled, $V_{OUT\_ENn} = 0.1\text{V}$	●	3	6	9	mA
	Output Leakage Current	$0\text{V} \leq V_{VOUT\_ENn} \leq 6\text{V}$	●			±1	$\mu\text{A}$
<b><math>V_{IN\_EN}</math> Enable Output (<math>V_{IN\_EN}</math>) Characteristics</b>							
$V_{VIN\_EN}$	Output High Voltage	$I_{VIN\_EN} = -5\mu\text{A}$ , $V_{DD33} = 3.3\text{V}$	●	10	12.5	14.7	V
$I_{VIN\_EN}$	Output Sourcing Current	$V_{IN\_EN}$ Pull-Up Enabled, $V_{VIN\_EN} = 1\text{V}$	●	-5	-6	-8	$\mu\text{A}$
	Output Sinking Current	$V_{VIN\_EN} = 0.4\text{V}$	●	3	5	8	mA
	Leakage Current	Internal Pull-Up Disabled, $0\text{V} \leq V_{VIN\_EN} \leq 15\text{V}$	●			±1	$\mu\text{A}$
<b>EEPROM Characteristics</b>							
Endurance	(Notes 6, 9)	$0^\circ\text{C} < T_J < 85^\circ\text{C}$ During EEPROM Write Operations	●	10,000		Cycles	
Retention	(Notes 6, 9)	$T_J < 85^\circ\text{C}$	●	10		Years	
$t_{MASS\_WRITE}$	Mass Write Operation Time (Note 7)	STORE_USER_ALL, $0^\circ\text{C} < T_J < 85^\circ\text{C}$ During EEPROM Write Operations	●		440	4100	ms
<b>Digital Inputs SCL, SDA, CONTROL0, CONTROL1, WDI/RESETB, FAULTB00, FAULTB01, FAULTB10, FAULTB11, WP</b>							
$V_{IH}$	High Level Input Voltage		●	2.1		V	
$V_{IL}$	Low Level Input Voltage		●		1.5	V	
$V_{HYST}$	Input Hysteresis			20		mV	
$I_{LEAK}$	Input Leakage Current	$0\text{V} \leq V_{PIN} \leq 5.5\text{V}$ , SDA, SCL, CONTROL $n$ Pins Only	●			±2	$\mu\text{A}$
		$0\text{V} \leq V_{PIN} \leq V_{DD33} + 0.3\text{V}$ , FAULTB $zn$ , WDI/RESETB, WP Pins Only	●			±2	$\mu\text{A}$
$t_{SP}$	Pulse Width of Spike Suppressed	FAULTB $zn$ , CONTROL $n$ Pins Only			10		$\mu\text{s}$
		SDA, SCL Pins Only			98		ns
$t_{FAULT\_MIN}$	Minimum Low Pulse Width for Externally Generated Faults			110		ms	
$t_{RESETB}$	Pulse Width to Assert Reset	$V_{WDI/RESETB} \leq 1.5\text{V}$	●	300		$\mu\text{s}$	
$t_{WDI}$	Pulse Width to Reset Watchdog Timer	$V_{WDI/RESETB} \leq 1.5\text{V}$	●	0.3	200	$\mu\text{s}$	

**ELECTRICAL CHARACTERISTICS** The ● denotes the specifications which apply over the full operating temperature range, otherwise specifications are at  $T_J = 25^\circ\text{C}$ .  $V_{PWR} = V_{IN\_SNS} = 12\text{V}$ ;  $V_{DD33}$ ,  $V_{DD25}$ , REFP and REFM pins floating, unless otherwise indicated.  $C_{VDD33} = 100\text{nF}$ ,  $C_{VDD25} = 100\text{nF}$  and  $C_{REF} = 100\text{nF}$ .

SYMBOL	PARAMETER	CONDITIONS	MIN	TYP	MAX	UNITS	
$f_{WDI}$	Watchdog Interrupt Input Frequency	●			1	MHz	
$C_{IN}$	Digital Input Capacitance			10		pF	
<b>Digital Input SHARE_CLK</b>							
$V_{IH}$	High Level Input Voltage	●	1.6			V	
$V_{IL}$	Low Level Input Voltage	●			0.8	V	
$f_{SHARE\_CLK\_IN}$	Input Frequency Operating Range	●	90		110	kHz	
$t_{LOW}$	Assertion Low Time	$V_{SHARE\_CLK} < 0.8\text{V}$	●	0.825	1.1	$\mu\text{s}$	
$t_{RISE}$	Rise Time	$V_{SHARE\_CLK} < 0.8\text{V}$ to $V_{SHARE\_CLK} > 1.6\text{V}$	●		450	ns	
$I_{LEAK}$	Input Leakage Current	$0\text{V} \leq V_{SHARE\_CLK} \leq V_{DD33} + 0.3\text{V}$	●		$\pm 1$	$\mu\text{A}$	
$C_{IN}$	Input Capacitance			10		pF	
<b>Digital Outputs SDA, ALERTB, PWRGD, SHARE_CLK, FAULTB00, FAULTB01, FAULTB10, FAULTB11</b>							
$V_{OL}$	Digital Output Low Voltage	$I_{SINK} = 3\text{mA}$	●		0.4	V	
$f_{SHARE\_CLK\_OUT}$	Output Frequency Operating Range	$5.49\text{k}\Omega$ Pull-Up to $V_{DD33}$	●	90	100	110	kHz
<b>Digital Inputs ASELO,ASEL1</b>							
$V_{IH}$	Input High Threshold Voltage	●	$V_{DD33} - 0.5$			V	
$V_{IL}$	Input Low Threshold Voltage	●			0.5	V	
$I_{IH,IL}$	High, Low Input Current	$ASEL[1:0] = 0, V_{DD33}$	●		$\pm 95$	$\mu\text{A}$	
$I_{IH,Z}$	Hi-Z Input Current	●			$\pm 24$	$\mu\text{A}$	
$C_{IN}$	Input Capacitance			10		pF	
<b>Serial Bus Timing Characteristics</b>							
$f_{SCL}$	Serial Clock Frequency (Note 8)	●	10		400	kHz	
$t_{LOW}$	Serial Clock Low Period (Note 8)	●	1.3			$\mu\text{s}$	
$t_{HIGH}$	Serial Clock High Period (Note 8)	●	0.6			$\mu\text{s}$	
$t_{BUF}$	Bus Free Time Between Stop and Start (Note 8)	●	1.3			$\mu\text{s}$	
$t_{HD,STA}$	Start Condition Hold Time (Note 8)	●	600			ns	
$t_{SU,STA}$	Start Condition Setup Time (Note 8)	●	600			ns	
$t_{SU,STO}$	Stop Condition Setup Time (Note 8)	●	600			ns	
$t_{HD,DAT}$	Data Hold Time (LTC2978A Receiving Data) (Note 8)	●	0			ns	
	Data Hold Time (LTC2978A Transmitting Data) (Note 8)	●	300		900	ns	
$t_{SU,DAT}$	Data Setup Time (Note 8)	●	100			ns	
$t_{SP}$	Pulse Width of Spike Suppressed (Note 8)			98		ns	
$t_{TIMEOUT\_BUS}$	Time Allowed to Complete any PMBus Command after Which Time SDA Will Be Released and Command Terminated	Longer Timeout = 0 Longer Timeout = 1	● ●	25 200	35 280	ms ms	
<b>Additional Digital Timing Characteristics</b>							
$t_{OFF\_MIN}$	Minimum Off-Time for Any Channel			100		ms	



## ELECTRICAL CHARACTERISTICS

**Note 1:** Stresses beyond those listed under Absolute Maximum Ratings may cause permanent damage to the device. Exposure to any Absolute Maximum Rating for extended periods may affect device reliability and lifetime.

**Note 2:** All currents into device pins are positive. All currents out of device pins are negative. All voltages are referenced to ground unless otherwise specified. If power is supplied to the chip via the  $V_{DD33}$  pin only, connect  $V_{PWR}$  and  $V_{DD33}$  pins together.

**Note 3:** Hysteresis in the output voltage is created by package stress that differs depending on whether the IC was previously at a higher or lower temperature. Output voltage is always measured at 25°C, but the IC is cycled to 85°C or -40°C before successive measurements. Hysteresis is roughly proportional to the square of the temperature change.

**Note 4:** The time between successive ADC conversions (latency of the ADC) for any given channel is given as:  $36.9\text{ms} + (6.15\text{ms} \cdot \text{number of ADC channels configured in Low Resolution mode}) + (24.6\text{ms} \cdot \text{number of ADC channels configured in High Resolution mode})$ .

**Note 5:** Nonlinearity is defined from the first code that is greater than or equal to the maximum offset specification to full-scale code, 1023.

**Note 6:** EEPROM endurance and retention are guaranteed by design, characterization and correlation with statistical process controls. The minimum retention specification applies for devices whose EEPROM has been cycled less than the minimum endurance specification.

**Note 7:** The LTC2978A will not acknowledge any PMBus commands while a mass write operation is being executed. This includes the STORE\_USER\_ALL and MFR\_FAULT\_LOG\_STORE commands or a fault log store initiated by a channel faulting off.

**Note 8:** Maximum capacitive load,  $C_B$ , for SCL and SDA is 400pF. Data and clock rise time ( $t_r$ ) and fall time ( $t_f$ ) are:  $(20 + 0.1 \cdot C_B) \text{ (ns)} < t_r < 300\text{ns}$  and  $(20 + 0.1 \cdot C_B) \text{ (ns)} < t_f < 300\text{ns}$ .  $C_B$  = capacitance of one bus line in pF. SCL and SDA external pull-up voltage,  $V_{I0}$ , is  $3.13\text{V} < V_{I0} < 5.5\text{V}$ .

**Note 9:** EEPROM endurance and retention will be degraded when  $T_J > 85^\circ\text{C}$ .

**Note 10:** Output enable pins are charge-pumped from  $V_{DD33}$ .

**Note 11:** The current sense resolution is determined by the L11 format and the mV units of the returned value. For example a full scale value of 170mV returns an L11 value of  $0xF2A8 = 680 \cdot 2^{-2} = 170$ . This is the lowest range that can represent this value without overflowing the L11 mantissa and the resolution for 1LSB in this range is  $2^{-2} \text{ mV} = 250\mu\text{V}$ . Each successively lower range improves resolution by cutting the LSB size in half.

## PMBUS TIMING DIAGRAM

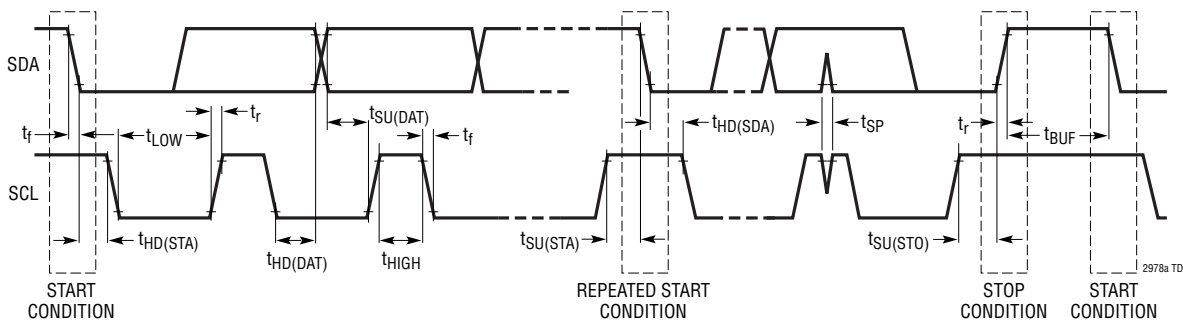

## TYPICAL PERFORMANCE CHARACTERISTICS

Reference Voltage vs Temperature

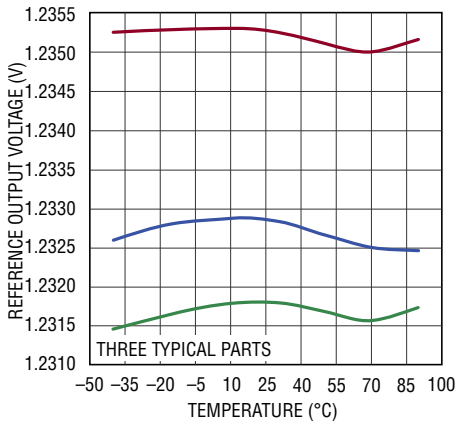

2978a G01

Temperature Sensor Error vs Temperature

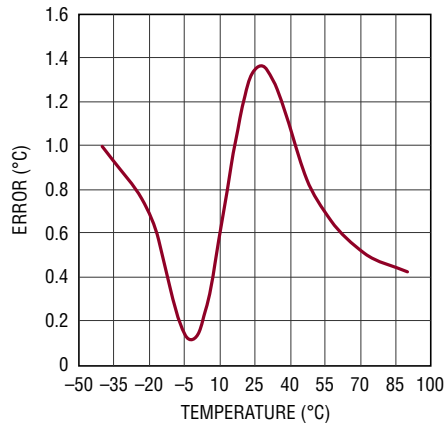

2978a G02

ADC Total Unadjusted Error vs Temperature

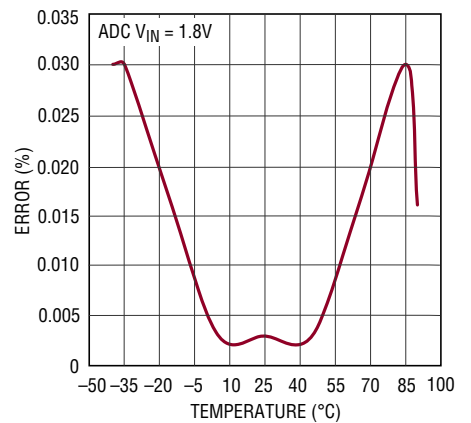

2978a G03

ADC Zero Code Center Offset Voltage vs Temperature

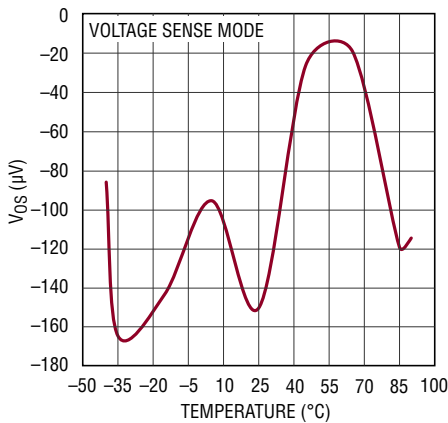

2978a G04

ADC-INL

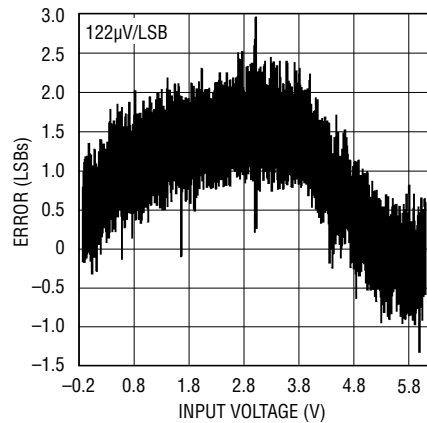

2978a G05

ADC-DNL

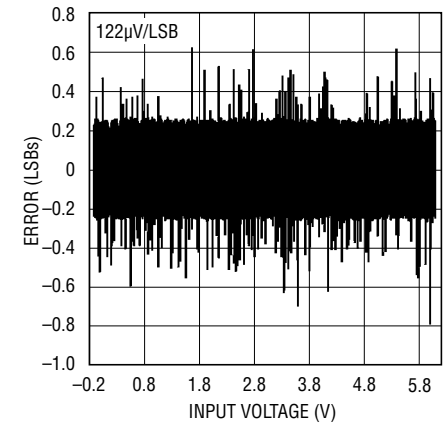

2978a G06

ADC Rejection vs Frequency at  $V_{IN}$

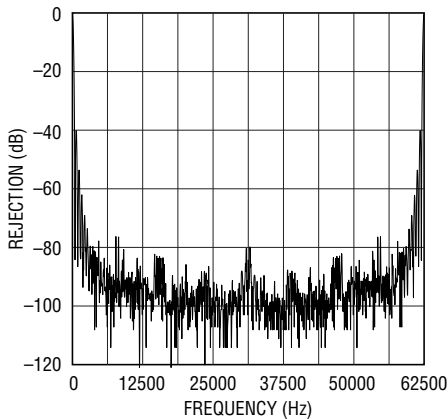

2978a G07

ADC Rejection vs Frequency at  $V_{IN}$  (Zoom)

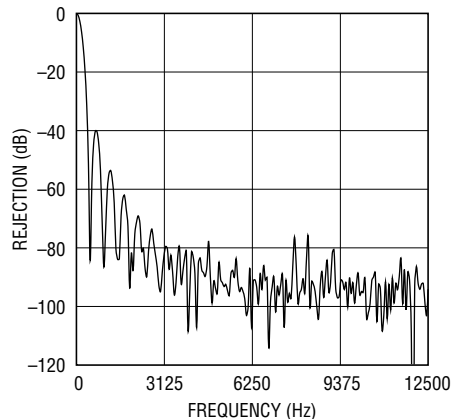

2978a G08

ADC Rejection vs Frequency at  $V_{IN}$  (Current Sense Mode)

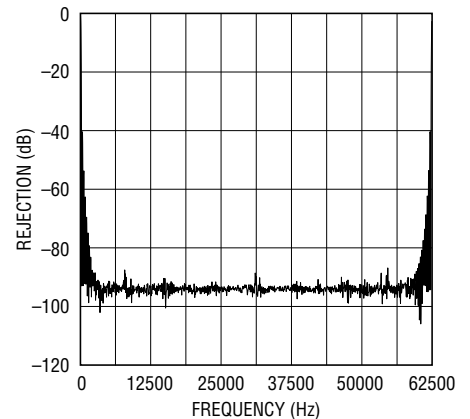

2978a G09

2978afb

# TYPICAL PERFORMANCE CHARACTERISTICS

**ADC Rejection vs Frequency at  $V_{IN}$  (Current Sense Mode, Zoom)**

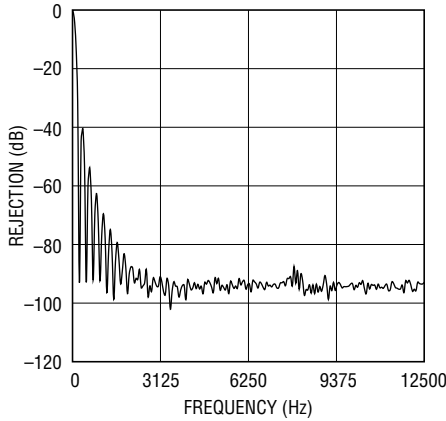

2978a G10

**ADC Noise Histogram**

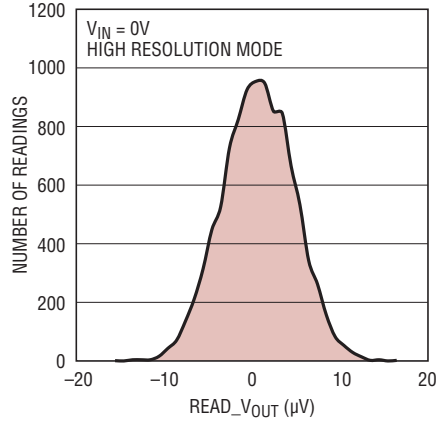

2978a G11

**Voltage Supervisor Total Unadjusted Error vs Temperature**

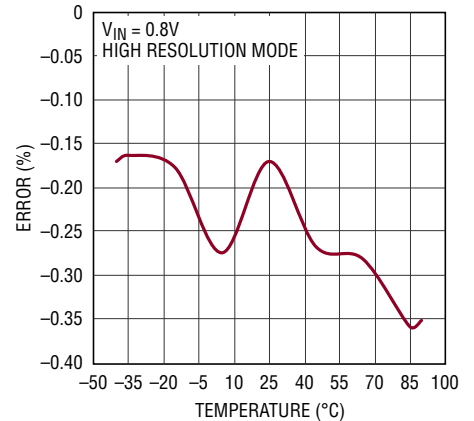

2978a G12

**Input Sampling Current vs Differential Input Voltage**

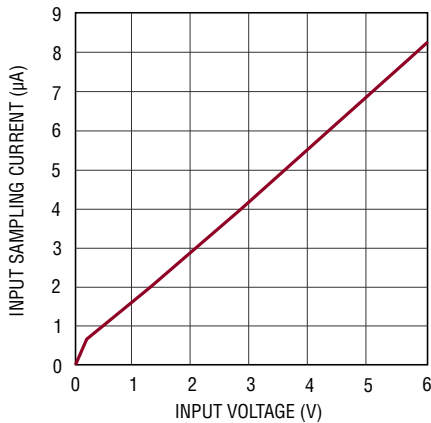

2978a G13

**ADC High Resolution Mode Differential Input Current**

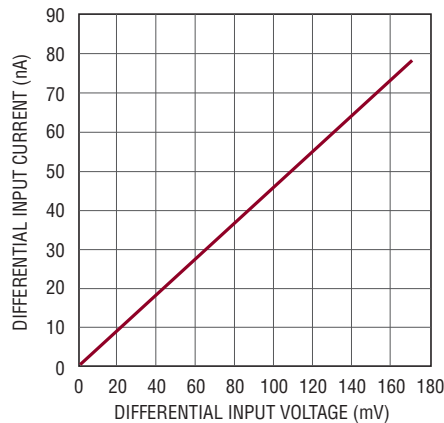

2978a G14

**DAC Full-Scale Output Voltage vs Temperature**

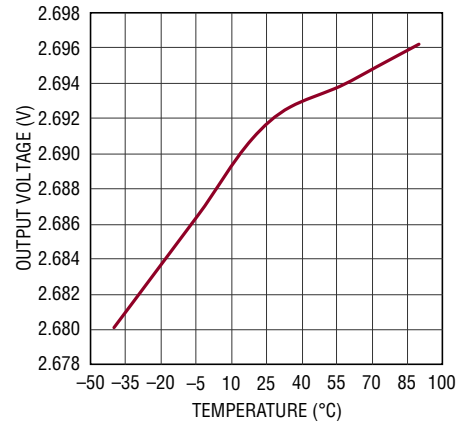

2978a G15

**DAC Offset Voltage vs Temperature**

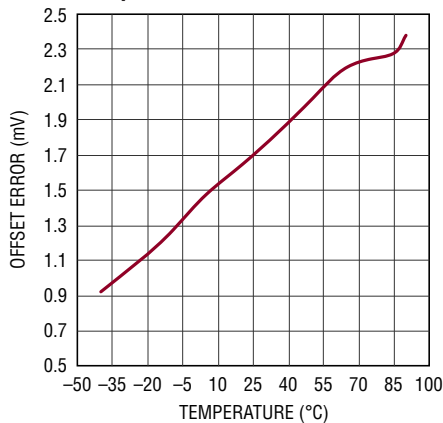

2978a G16

**DAC-INL**

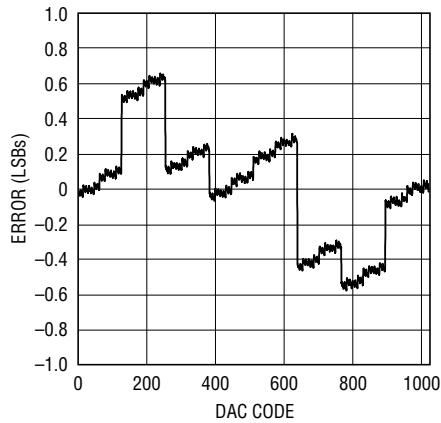

2978a G17

**DAC-DNL**

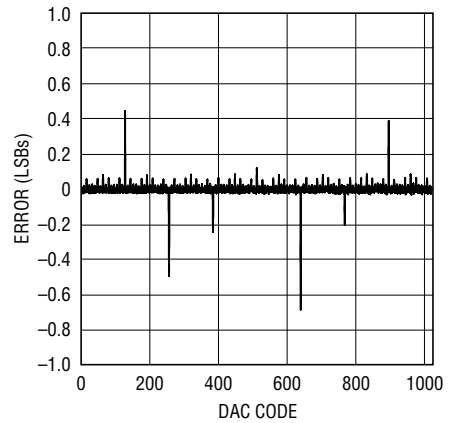

2978a G18

2978afb

## TYPICAL PERFORMANCE CHARACTERISTICS

**DAC Load Regulation (Sourcing)**

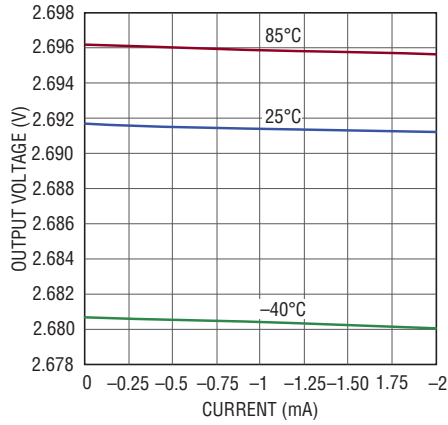

2978a G19

**DAC Load Regulation (Sinking)**

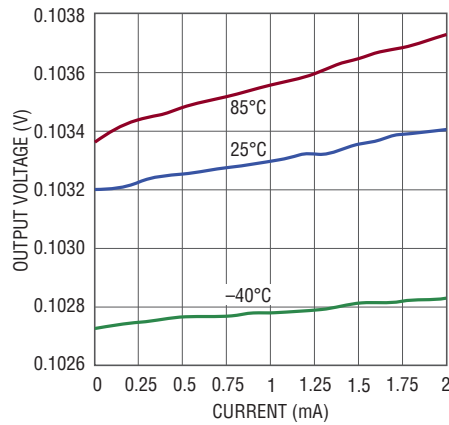

2978a G20

**DAC Short-Circuit Current vs Temperature**

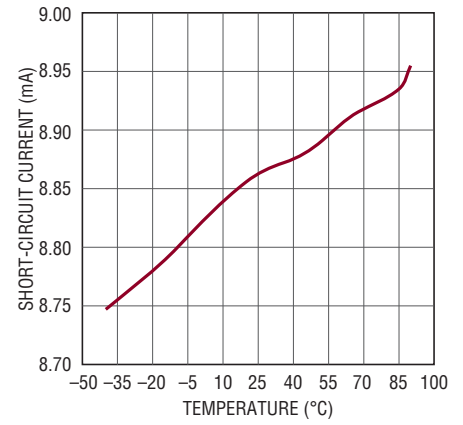

2978a G21

**DAC Transient Response to 1LSB DAC Code Change**

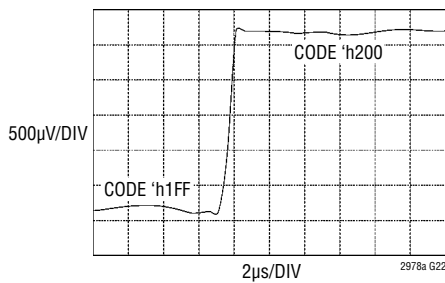

2978a G22

**DAC Soft-Connect Transient Response when Transitioning from Hi-Z State to ON State**

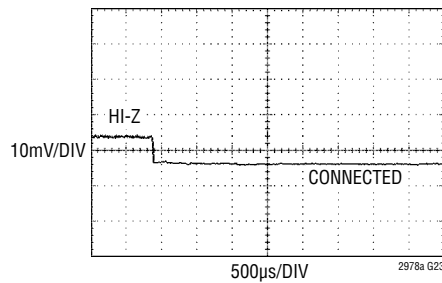

100k SERIES RESISTANCE ON CODE: 'h1FF

2978a G23

**DAC Soft-Connect Transient Response when Transitioning from ON State to Hi-Z State**

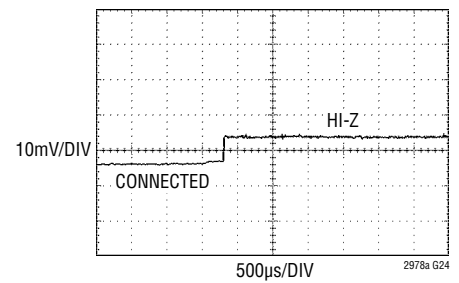

100k SERIES RESISTANCE ON CODE: 'h1FF

2978a G24

# TYPICAL PERFORMANCE CHARACTERISTICS

**V<sub>DD33</sub> Regulator Output Voltage vs Temperature**

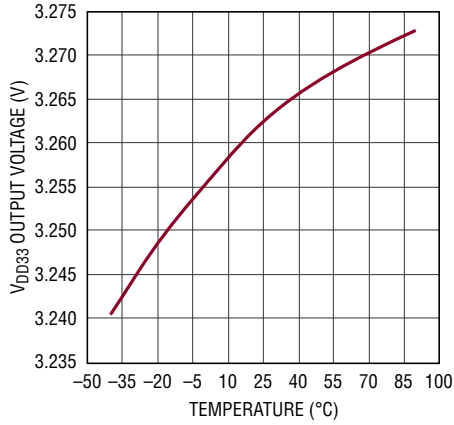

2978a G25

**V<sub>DD33</sub> Regulator Line Regulation**

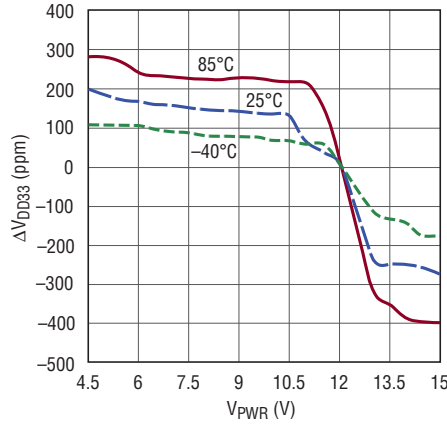

2978a G26

**V<sub>DD33</sub> Regulator Short-Circuit Current vs Temperature**

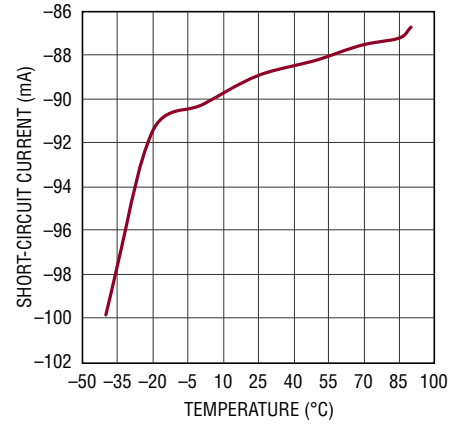

2978a G27

**Supply Current vs Supply Voltage**

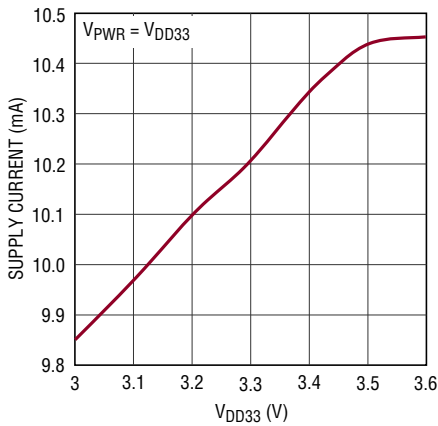

2978a G28

**Supply Current vs Temperature**

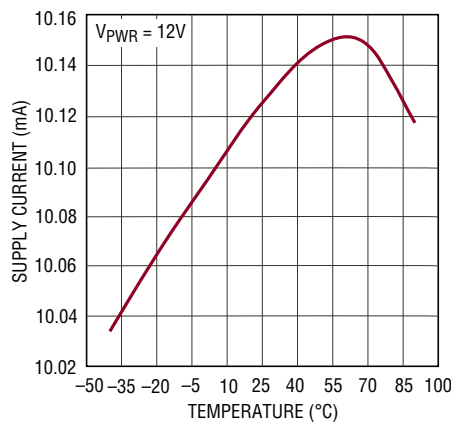

2978a G29

**V<sub>OUT\_EN[3:0]</sub> and V<sub>IN\_EN</sub> Output High Voltage vs Load Current**

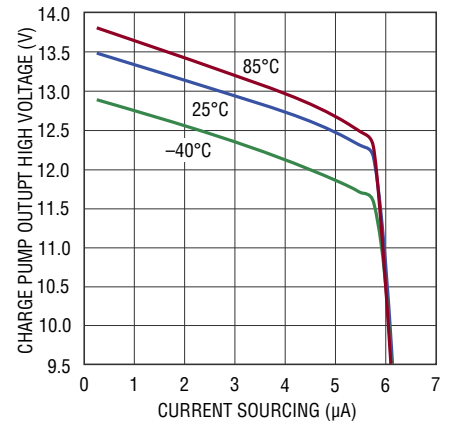

2978a G30

## TYPICAL PERFORMANCE CHARACTERISTICS

**DAC Output Impedance vs Frequency**

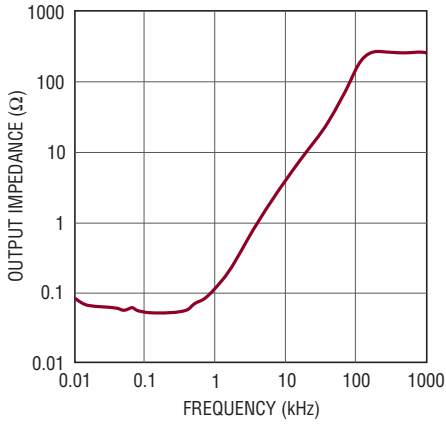

2978a G31

**V<sub>OUT\_EN[3:0]</sub> and V<sub>IN\_EN</sub> V<sub>OL</sub> vs Current**

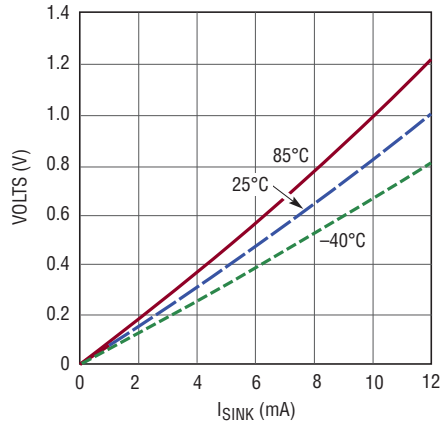

2978a G32

**V<sub>OUT\_EN[7:4]</sub> V<sub>OL</sub> vs Current**

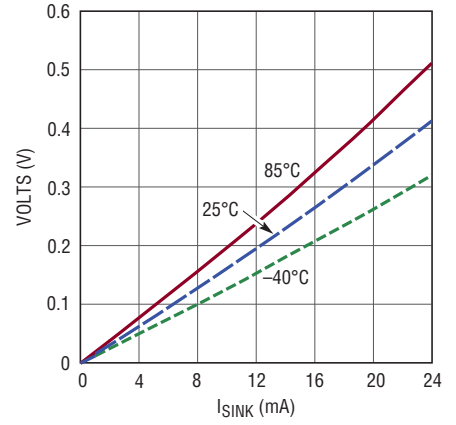

2978a G33

**PWRGD and FAULTB<sub>zn</sub> V<sub>OL</sub> vs Current**

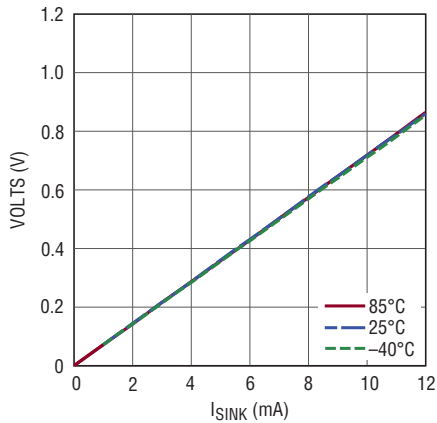

2978a G34

**ALERTB V<sub>OL</sub> vs Current**

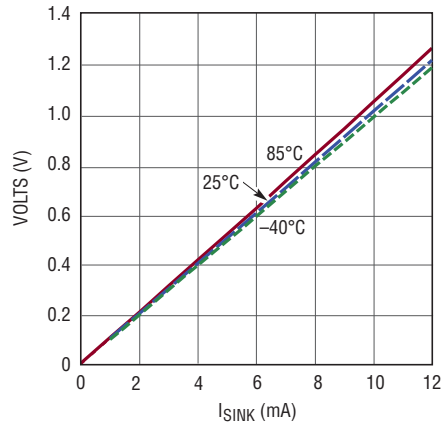

2978a G35



## PIN FUNCTIONS

PIN NAME	PIN NUMBER	PIN TYPE	DESCRIPTION
V <sub>SENSE</sub> M6	1*	In	DC/DC Converter Differential (-) Output Voltage-6 Sensing Pin
V <sub>SENSE</sub> P7	2*	In	DC/DC Converter Differential (+) Output Voltage or Current-7 Sensing Pin
V <sub>SENSE</sub> M7	3*	In	DC/DC Converter Differential (-) Output Voltage or Current-7 Sensing Pin
V <sub>OUT</sub> _EN0	4	Out	DC/DC Converter Enable-0 Pin. Output High Voltage Optionally Pulled Up to 12V by 5 $\mu$ A
V <sub>OUT</sub> _EN1	5	Out	DC/DC Converter Enable-1 Pin. Output High Voltage Optionally Pulled Up to 12V by 5 $\mu$ A
V <sub>OUT</sub> _EN2	6	Out	DC/DC Converter Enable-2 Pin. Output High Voltage Optionally Pulled Up to 12V by 5 $\mu$ A
V <sub>OUT</sub> _EN3	7	Out	DC/DC Converter Enable-3 Pin. Output High Voltage Optionally Pulled Up to 12V by 5 $\mu$ A
V <sub>OUT</sub> _EN4	8	Out	DC/DC Converter Open-Drain Pull-Down Output-4
V <sub>OUT</sub> _EN5	9	Out	DC/DC Converter Open-Drain Pull-Down Output-5
V <sub>OUT</sub> _EN6	10	Out	DC/DC Converter Open-Drain Pull-Down Output-6
V <sub>OUT</sub> _EN7	11	Out	DC/DC Converter Open-Drain Pull-Down Output-7
V <sub>IN</sub> _EN	12	Out	DC/DC Converter V <sub>IN</sub> ENABLE Pin. Output High Voltage Optionally Pulled Up to 12V by 5 $\mu$ A
DNC	13	Do Not Connect	Do Not Connect to This Pin
V <sub>IN</sub> _SNS	14	In	V <sub>IN</sub> SENSE Input. This Voltage is Compared Against the V <sub>IN</sub> On and Off Voltage Thresholds in Order to Determine When to Enable and Disable, Respectively, the Downstream DC/DC Converters
V <sub>PWR</sub>	15	In	V <sub>PWR</sub> Serves as the Unregulated Power Supply Input to the Chip (4.5V to 15V). If a 4.5V to 15V Supply Voltage is Unavailable, Short V <sub>PWR</sub> to V <sub>DD33</sub> and Power the Chip Directly from a 3.3V Supply. Bypass to GND with 0.1 $\mu$ F Capacitor.
V <sub>DD33</sub>	16	In/Out	If Shorted to V <sub>PWR</sub> , it Serves as 3.13V to 3.47V Supply Input Pin. Otherwise it is a 3.3V Internally Regulated Voltage Output (Use 0.1 $\mu$ F Decoupling Capacitor to GND)
V <sub>DD33</sub>	17	In	Input for Internal 2.5V Sub-Regulator. Short This Pin to Pin 16
V <sub>DD25</sub>	18	In/Out	2.5V Internally Regulated Voltage Output. Bypass to GND with a 0.1 $\mu$ F Capacitor
WP	19	In	Digital Input. Write-Protect Input Pin, Active High
PWRGD	20	Out	Power Good Open-Drain Output. Indicates When Outputs are Power Good. Can be Used as System Power-On Reset. The Latency of This Signal May Be as Long as the ADC Latency. See Note 4.
SHARE_CLK	21	In/Out	Bidirectional Clock Sharing Pin. Connect a 5.49k Pull-Up Resistor to V <sub>DD33</sub>
WDI/RESETB	22	In	Watchdog Timer Interrupt and Chip Reset Input. Connect a 10k Pull-Up Resistor to V <sub>DD33</sub> . Rising Edge Resets Watchdog Counter. Holding This Pin Low for More Than t <sub>RESETB</sub> Resets the Chip
FAULTB00	23	In/Out	Open-Drain Output and Digital Input. Active Low Bidirectional Fault Indicator-00. Connect a 10k Pull-Up Resistor to V <sub>DD33</sub>
FAULTB01	24	In/Out	Open-Drain Output and Digital Input. Active Low Bidirectional Fault Indicator-01. Connect a 10k Pull-Up Resistor to V <sub>DD33</sub>
FAULTB10	25	In/Out	Open-Drain Output and Digital Input. Active Low Bidirectional Fault Indicator-10. Connect a 10k Pull-Up Resistor to V <sub>DD33</sub>
FAULTB11	26	In/Out	Open-Drain Output and Digital Input. Active Low Bidirectional Fault Indicator-11. Connect a 10k Pull-Up Resistor to V <sub>DD33</sub>
SDA	27	In/Out	PMBus Bidirectional Serial Data Pin
SCL	28	In	PMBus Serial Clock Input Pin (400kHz Maximum)
ALERTB	29	Out	Open-Drain Output. Generates an Interrupt Request in a Fault/Warning Situation
CONTROL0	30	In	Control Pin 0 Input
CONTROL1	31	In	Control Pin 1 Input
ASEL0	32	In	Ternary Address Select Pin 0 Input. Connect to V <sub>DD33</sub> , GND or Float to Encode 1 of 3 Logic States
ASEL1	33	In	Ternary Address Select Pin 1 Input. Connect to V <sub>DD33</sub> , GND or Float to Encode 1 of 3 Logic States
REFP	34	Out	Reference Voltage Output. Needs 0.1 $\mu$ F Decoupling Capacitor to REFM
REFM	35	Out	Reference Return Pin. Needs 0.1 $\mu$ F Decoupling Capacitor to REFP.
V <sub>SENSE</sub> P0	36*	In	DC/DC Converter Differential (+) Output Voltage-0 Sensing Pin
V <sub>SENSE</sub> M0	37*	In	DC/DC Converter Differential (-) Output Voltage-0 Sensing Pin
V <sub>DAC</sub> M0	38*	Out	DAC0 Return. Connect to Channel 0 DC/DC Converter's GND Sense or Return to GND
V <sub>DAC</sub> P0	39	Out	DAC0 Output
V <sub>DAC</sub> P1	40	Out	DAC1 Output

## PIN FUNCTIONS

PIN NAME	PIN NUMBER	PIN TYPE	DESCRIPTION
V <sub>DACM1</sub>	41*	Out	DAC1 Return. Connect to Channel 1 DC/DC Converter's GND Sense or Return to GND
V <sub>SENSEP1</sub>	42*	In	DC/DC Converter Differential (+) Output Voltage or Current-1 Sensing Pins
V <sub>SENSEM1</sub>	43*	In	DC/DC Converter Differential (-) Output Voltage or Current-1 Sensing Pins
V <sub>DACP2</sub>	44	Out	DAC2 Output
V <sub>DACM2</sub>	45*	Out	DAC2 Return. Connect to Channel 2 DC/DC Converter's GND Sense or Return to GND
V <sub>SENSEP2</sub>	46*	In	DC/DC Converter Differential (+) Output Voltage-2 Sensing Pin
V <sub>SENSEM2</sub>	47*	In	DC/DC Converter Differential (-) Output Voltage-2 Sensing Pin
V <sub>SENSEP3</sub>	48*	In	DC/DC Converter Differential (+) Output Voltage or Current-3 Sensing Pins
V <sub>SENSEM3</sub>	49*	In	DC/DC Converter Differential (-) Output Voltage or Current-3 Sensing Pins
V <sub>DACP3</sub>	50	Out	DAC3 Output
V <sub>DACM3</sub>	51*	Out	DAC3 Return. Connect to Channel 3 DC/DC Converter's GND Sense or Return to GND
V <sub>SENSEP4</sub>	52*	In	DC/DC Converter Differential (+) Output Voltage-4 Sensing Pin
V <sub>SENSEM4</sub>	53*	In	DC/DC Converter Differential (-) Output Voltage-4 Sensing Pin
V <sub>DACM4</sub>	54*	Out	DAC4 Return. Connect to Channel 4 DC/DC Converter's GND Sense or Return to GND
V <sub>DACP4</sub>	55	Out	DAC4 Output
V <sub>DACP5</sub>	56	Out	DAC5 Output
V <sub>DACM5</sub>	57*	Out	DAC5 Return. Connect to Channel 5 DC/DC Converter's GND Sense or Return to GND
V <sub>DACM6</sub>	58*	Out	DAC6 Return. Connect to Channel 6 DC/DC Converter's GND Sense or Return to GND
V <sub>DACP6</sub>	59	Out	DAC6 Output
V <sub>DACP7</sub>	60	Out	DAC7 Output
V <sub>DACM7</sub>	61*	Out	DAC7 Return. Connect to Channel 7 DC/DC Converter's GND Sense or Return to GND
V <sub>SENSEP5</sub>	62*	In	DC/DC Converter Differential (+) Output Voltage or Current-5 Sensing Pins
V <sub>SENSEM5</sub>	63*	In	DC/DC Converter Differential (-) Output Voltage or Current-5 Sensing Pins
V <sub>SENSEP6</sub>	64*	In	DC/DC Converter Differential (+) Output Voltage-6 Sensing Pin
GND	65	Ground	Exposed Pad, Must be Soldered to PCB

\*Any unused V<sub>SENSEP<sub>n</sub></sub> or V<sub>SENSEM<sub>n</sub></sub> or V<sub>DACM<sub>n</sub></sub> pins must be tied to GND.

# BLOCK DIAGRAM

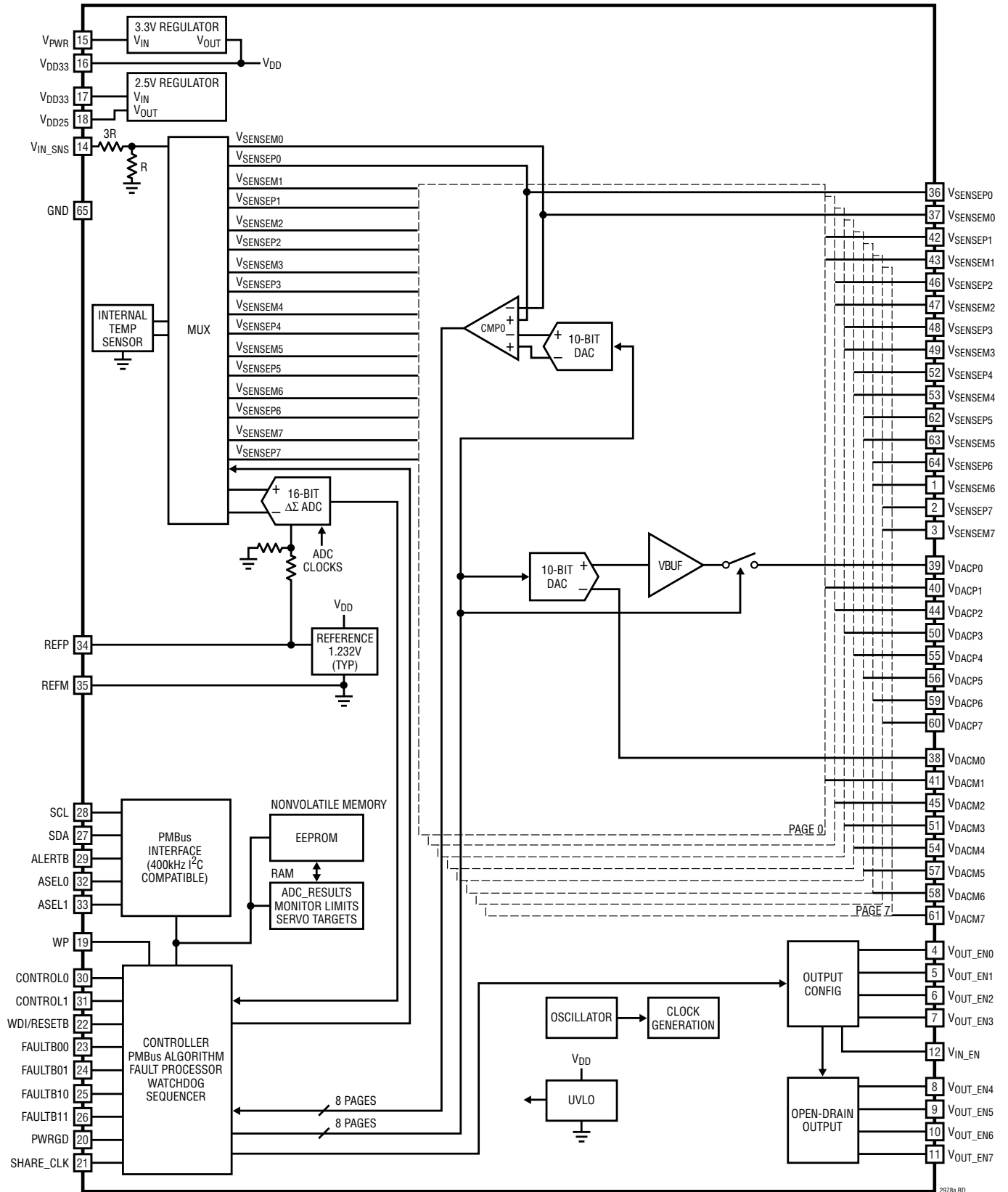

2978a BD

## OPERATION

### OPERATION OVERVIEW

The LTC2978A is a PMBus programmable power system controller, monitor, sequencer and voltage supervisor that can perform the following operations:

- Accept PMBus compatible programming commands.
- Provide DC/DC converter input voltage and output voltage/current read back through the PMBus interface.
- Control the output of DC/DC converters that set the output voltage with a trim pin or DC/DC converters that set the output voltage using an external resistor feedback network.
- Sequence the start-up of DC/DC converters via PMBus programming and their control input pins.
- Trim the DC/DC converter output voltage (typically in 0.02% steps), in closed-loop servo operating mode, through PMBus programming.
- Margin the DC/DC converter output voltage to PMBus programmed limits.
- Allow the user to trim or margin the DC/DC converter output voltage in a manual operating mode by providing direct access to the margin DAC.
- Supervise the DC/DC converter output voltage, input voltage, and the LTC2978A die temperature for over-value/undervalue conditions with respect to PMBus programmed limits and generate appropriate faults and warnings.
- Respond to a fault condition by either continuing operation indefinitely, latching off after a programmable deglitch period or latching off immediately. A retry mode may be used to automatically recover from a latched-off condition.
- Optionally stop trimming the DC/DC converter output voltage after it reached the initial margin or nominal target. Optionally allow servo to resume if target drifts outside of  $V_{OUT}$  warning limits.
- Store command register contents with CRC to EEPROM through PMBus programming.
- Restore EEPROM contents through PMBus programming or when  $V_{DD33}$  is applied on power-up.
- Report the DC/DC converter output voltage status through the PMBus interface and the power good output.
- Generate interrupt requests by asserting the ALERTB pin in response to supported PMBus faults and warnings.
- Coordinate system wide fault responses for all DC/DC converters connected to the FAULTBz0 and FAULTBz1 pins.
- Synchronize sequencing delays or shutdown for multiple devices using the SHARE\_CLK pin.
- Software and hardware write protect the command registers.
- Disable the input voltage to the supervised DC/DC converters in response to output voltage OV and UV faults.
- Log telemetry and status data to EEPROM in response to a faulted-off condition
- Supervise an external microcontroller's activity for a stalled condition with a programmable watchdog timer and reset it if necessary.
- Prevent a DC/DC converter from re-entering the ON state after a power cycle until a programmable interval (MFR\_RESTART\_DELAY) has elapsed and its output has decayed below a programmable threshold voltage (MFR\_VOUT\_DISCHARGE\_THRESHOLD).
- Record minimum and maximum observed values of input voltage, output voltages and temperature.

### EEPROM

The LTC2978A contains internal EEPROM (nonvolatile memory) to store configuration settings and fault log information. EEPROM endurance, retention, and mass write operation time are specified over the operating junction temperature range. See Electrical Characteristics and Absolute Maximum Ratings sections.

## OPERATION

Nondestructive operation above  $T_J = 85^\circ\text{C}$  is possible although the Electrical Characteristics are not guaranteed and the EEPROM will be degraded.

Operating the EEPROM above  $85^\circ\text{C}$  may result in a degradation of retention characteristics. The fault logging function, which is useful in debugging system problems that may occur at high temperatures, only writes to fault log EEPROM locations. If occasional writes to these registers occur above  $85^\circ\text{C}$ , a slight degradation in the data retention characteristics of the fault log may occur.

It is recommended that the EEPROM not be written using STORE\_USER\_ALL or bulk programming when  $T_J > 85^\circ\text{C}$ .

The degradation in EEPROM retention for temperatures  $> 85^\circ\text{C}$  can be approximated by calculating the dimensionless acceleration factor using the following equation.

$$AF = e^{\left[ \left( \frac{E_a}{k} \right) \cdot \left( \frac{1}{T_{\text{USE}} + 273} - \frac{1}{T_{\text{STRESS}} + 273} \right) \right]}$$

Where:

AF = acceleration factor

$E_a$  = activation energy = 1.4 eV

$k = 8.625 \times 10^{-5}$  eV/ $^\circ\text{K}$

$T_{\text{USE}} = 85^\circ\text{C}$  specified junction temperature

$T_{\text{STRESS}}$  = actual junction temperature  $^\circ\text{C}$

Example: Calculate the effect on retention when operating at a junction temperature of  $95^\circ\text{C}$  for 10 hours.

$T_{\text{STRESS}} = 95^\circ\text{C}$

$T_{\text{USE}} = 85^\circ\text{C}$

AF = 3.4

Equivalent operating time at  $85^\circ\text{C} = 34$  hours.

So the overall retention of the EEPROM was degraded by 34 hours as a result of operation at a junction temperature of  $95^\circ\text{C}$  for 10 hours. Note that the effect of this overstress is negligible when compared to the overall EEPROM retention rating of 87,600 hours at a maximum junction temperature of  $85^\circ\text{C}$ .

## RESET

Holding the WDI/RESETB pin low for more than  $t_{\text{RESETB}}$  will cause the LTC2978A to enter the power-on reset state. While in the power-on reset state, the device will not communicate on the I<sup>2</sup>C bus. Following the subsequent rising-edge of the WDI/RESETB pin, the LTC2978A will execute its power-on sequence per the user configuration stored in EEPROM. Connect WDI/RESETB to VDD33 with a 10k resistor. WDI/RESETB includes an internal 256 $\mu\text{s}$  deglitch filter so additional filter capacitance on this pin is not recommended.

## WRITE-PROTECT PIN

The WP pin allows the user to write-protect the LTC2978A's configuration registers. The WP pin is active high, and when asserted it provides Level 2 protection: all writes are disabled except to the WRITE\_PROTECT, PAGE, STORE\_USER\_ALL, OPERATION, MFR\_PAGE\_FF\_MASK and CLEAR\_FAULTS commands. The most restrictive setting between the WP pin and WRITE\_PROTECT command will override. For example if WP = 1 and WRITE\_PROTECT = 0x80, then the WRITE\_PROTECT command overrides, since it is the most restrictive.

## OTHER OPERATIONS

### Clock Sharing

Multiple ADI PMBus devices can synchronize their clocks in an application by connecting together the open-drain SHARE\_CLK input/outputs to a pull-up resistor as a wired OR. In this case the fastest clock will take over and synchronize all LTC2978As.

SHARE\_CLK can optionally be used to synchronize ON/OFF dependency on  $V_{\text{IN}}$  across multiple chips by setting the Mfr\_config\_all\_vin\_share\_enable bit of the MFR\_CONFIG\_ALL\_LTC2978 register. When configured this way the chip will hold SHARE\_CLK low when the unit is off for insufficient input voltage, and upon detecting that SHARE\_CLK is held low the chip will disable all channels after a brief deglitch period. When the SHARE\_CLK pin is allowed to rise, the

## OPERATION

chip will respond by beginning a soft-start sequence. In this case the slowest VIN\_ON detection will take over and synchronize other chips to its soft-start sequence.

### PMBus SERIAL DIGITAL INTERFACE

The LTC2978A communicates with a host (master) using the standard PMBus serial bus interface. The PMBus Timing Diagram shows the timing relationship of the signals on the bus. The two bus lines, SDA and SCL, must be high when the bus is not in use. External pull-up resistors or current sources are required on these lines.

The LTC2978A is a slave device. The master can communicate with the LTC2978A using the following formats:

- Master transmitter, slave receiver
- Master receiver, slave transmitter

The following SMBus protocols are supported:

- Write Byte, Write Word, Send Byte
- Read Byte, Read Word, Block Read
- Alert Response Address

Figures 1-12 illustrate the aforementioned SMBus protocols. All transactions support PEC (parity error check) and GCP (group command protocol). The Block Read supports 255 bytes of returned data. For this reason, the PMBus timeout may be extended using the Mfr\_config\_all\_longer\_pmbus\_timeout setting.

The LTC2978A will not acknowledge any PMBus command if it is still busy with a STORE\_USER\_ALL, RESTORE\_USER\_ALL, MFR\_CONFIG\_LTC2978 or if fault log data is being written to the EEPROM. Status\_word\_busy will also be set, but ALERTB will not be asserted low.

### PMBus

PMBus is an industry standard that defines a means of communication with power conversion devices. It is comprised of an industry standard SMBus serial interface and the PMBus command language.

The PMBus two wire interface is an incremental extension of the SMBus. SMBus is built upon I<sup>2</sup>C with some minor differences in timing, DC parameters and protocol. The SMBus protocols are more robust than simple I<sup>2</sup>C byte commands because they provide timeouts to prevent bus hangs and optional packet error checking (PEC) to ensure data integrity. In general, a master device that can be configured for I<sup>2</sup>C communication can be used for PMBus communication with little or no change to hardware or firmware.

For a description of the minor extensions and exceptions PMBus makes to SMBus, refer to PMBus Specification Part 1 Revision 1.1: paragraph 5: Transport. This can be found at:

[www.pmbus.org](http://www.pmbus.org).

For a description of the differences between SMBus and I<sup>2</sup>C, refer to system management bus (SMBus) specification version 2.0: Appendix B – Differences Between SMBus and I<sup>2</sup>C. This can be found at:

[www.smbus.org](http://www.smbus.org).

When using an I<sup>2</sup>C controller to communicate with a PMBus part it is important that the controller be able to write a byte of data without generating a stop. This will allow the controller to properly form the repeated start of the PMBus read command by concatenating a start command byte write with an I<sup>2</sup>C read.



# OPERATION

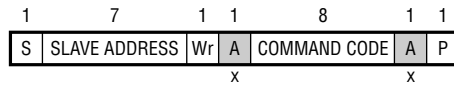

- S START CONDITION
- Sr REPEATED START CONDITION
- Rd READ (BIT VALUE OF 1)
- Wr WRITE (BIT VALUE OF 0)
- x SHOWN UNDER A FIELD INDICATES THAT THE FIELD IS REQUIRED TO HAVE THE VALUE OF x
- A ACKNOWLEDGE (THIS BIT POSITION MAY BE 0 FOR AN ACK OR 1 FOR A NACK)
- P STOP CONDITION
- PEC PACKET ERROR CODE
- MASTER TO SLAVE
- SLAVE TO MASTER
- ... CONTINUATION OF PROTOCOL

2978a F01a

Figure 1a. PMBus Packet Protocol Diagram Element Key

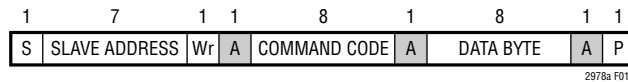

2978a F01b

Figure 1b. Write Byte Protocol

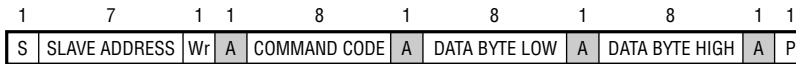

2978a F02

Figure 2. Write Word Protocol

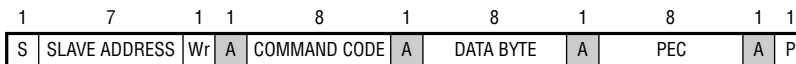

2978a F03

Figure 3. Write Byte Protocol with PEC

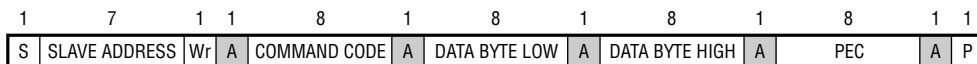

2978a F04

Figure 4. Write Word Protocol with PEC

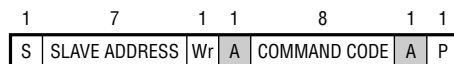

2978a F05

Figure 5. Send Byte Protocol

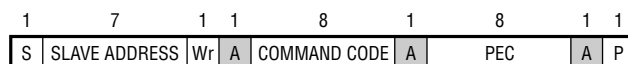

2978a F06

Figure 6. Send Byte Protocol with PEC

## OPERATION

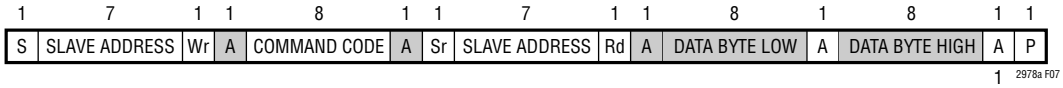

**Figure 7. Read Word Protocol**

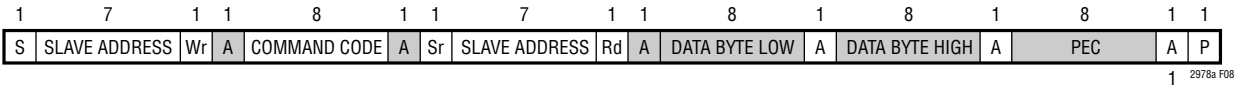

**Figure 8. Read Word Protocol with PEC**

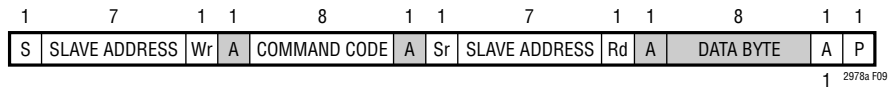

**Figure 9. Read Byte Protocol**

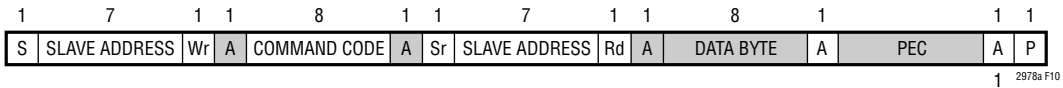

**Figure 10. Read Byte Protocol with PEC**

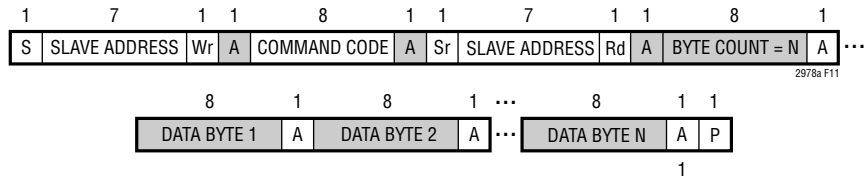

**Figure 11. Block Read**

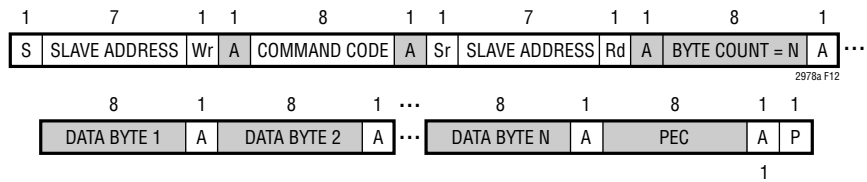

**Figure 12. Block Read with PEC**

## OPERATION

### Device Address

The I<sup>2</sup>C/SMBus address of the LTC2978A equals the base address + N where N is a number from 0 to 8. N can be configured by setting the ASEL0 and ASEL1 pins to V<sub>DD33</sub>, GND or FLOAT. See Table 1. Using one base address and the nine values of N, nine LTC2978As can be connected together to control 72 outputs. The base address is stored in the MFR\_I2C\_BASE\_ADDRESS register. The base address can be written to any value, but generally should not

be changed unless the desired range of addresses overlap existing addresses. Watch that the address range does not overlap with other I<sup>2</sup>C/SMBus device or global addresses, including I<sup>2</sup>C/SMBus multiplexers and bus buffers. This will bring you great happiness.

The LTC2978A always responds to its global address and the SMBus Alert Response address regardless of the state of its ASEL pins and the MFR\_I2C\_BASE\_ADDRESS register.

**Table 1. LTC2978A Device Address Look-Up Table**

ADDRESS DESCRIPTION	HEX DEVICE ADDRESS		BINARY DEVICE ADDRESS BITS								ADDRESS PINS	
	7-Bit	8-Bit	6	5	4	3	2	1	0	R/W	ASEL1	ASEL0
Alert Response	0C	19	0	0	0	1	1	0	0	1	X	X
Global	5B	B6	1	0	1	1	0	1	1	0	X	X
N = 0	5C*	B8	1	0	1	1	1	0	0	0	L	L
N = 1	5D	BA	1	0	1	1	1	0	1	0	L	NC
N = 2	5E	BC	1	0	1	1	1	1	0	0	L	H
N = 3	5F	BE	1	0	1	1	1	1	1	0	NC	L
N = 4	60	C0	1	1	0	0	0	0	0	0	NC	NC
N = 5	61	C2	1	1	0	0	0	0	1	0	NC	H
N = 6	62	C4	1	1	0	0	0	1	0	0	H	L
N = 7	63	C6	1	1	0	0	0	1	1	0	H	NC
N = 8	64	C8	1	1	0	0	1	0	0	0	H	H

H = Tie to V<sub>DD33</sub>, NC = No Connect = Open or Float, L = Tie to GND, X = Don't Care

\*MFR\_I2C\_BASE\_ADDRESS = 7bit 5C (Factory Default)

## OPERATION

### Processing Commands

The LTC2978A uses a dedicated processing block to ensure quick response to all of its commands. There are a few exceptions where the part will NACK a subsequent command because it is still processing the previous command. These are summarized in the following tables.

#### EEPROM Related Commands

COMMAND	TYPICAL DELAY*	COMMENT
STORE_USER_ALL	$t_{\text{MASS\_WRITE}}$	See Electrical Characteristics table. The LTC2978A will not accept any commands while it is transferring register contents to the EEPROM. The command byte will be NACKed.
RESTORE_USER_ALL	30ms	The LTC2978A will not accept any commands while it is transferring EEPROM data to command registers. The command byte will be NACKed.
MFR_FAULT_LOG_CLEAR	175ms	The LTC2978A will not accept any commands while it is initializing the fault log EEPROM space. The command byte will be NACKed.
MFR_FAULT_LOG_STORE	20ms	The LTC2978A will not accept any commands while it is transferring the fault log RAM buffer to EEPROM space. The command byte will be NACKed.
Internal Fault log	10ms	An internal fault log event is a one time event that uploads the contents of the fault log to EEPROM in response to a fault. Internal fault logging may be disabled. Commands received during this EEPROM write are NACKed.
MFR_FAULT_LOG_RESTORE	2ms	The LTC2978A will not accept any commands while it is transferring EEPROM data to the fault log RAM buffer. The command byte will be NACKed.

\*The typical delay is measured from the command's stop to the next command's start.

COMMAND	TYPICAL DELAY*	COMMENT
MFR_CONFIG_LTC2978	<50 $\mu$ s	The LTC2978A will not accept any commands while it is completing this command. The command byte will be NACKed.

\*The typical delay is measured from the command's stop to the next command's start.

#### Other PMBus Timing Notes

COMMAND	COMMENT
CLEAR_FAULTS	The LTC2978A will accept commands while it is completing this command but the affected status flags will not be cleared for up to 500 $\mu$ s.

## PMBus COMMAND SUMMARY

Summary Table

COMMAND NAME	CMD CODE	DESCRIPTION	TYPE	PAGED	DATA FORMAT	UNITS	EEPROM	DEFAULT VALUE FLOAT HEX	REF PAGE
PAGE	0x00	Channel or page currently selected for any command that supports paging.	R/W Byte	N	Reg			0x00	30
OPERATION	0x01	Operating mode control. On/Off, Margin High and Margin Low.	R/W Byte	Y	Reg		Y	0x00	31
ON_OFF_CONFIG	0x02	CONTROL pin & PMBus bus on/off command setting.	R/W Byte	Y	Reg		Y	0x12	32
CLEAR_FAULTS	0x03	Clear any fault bits that have been set.	Send Byte	Y				NA	32
WRITE_PROTECT	0x10	Level of protection provided by the device against accidental changes.	R/W Byte	N	Reg		Y	0x00	33
STORE_USER_ALL	0x15	Store entire operating memory to EEPROM.	Send Byte	N				NA	33
RESTORE_USER_ALL	0x16	Restore entire operating memory from EEPROM.	Send Byte	N				NA	33
CAPABILITY	0x19	Summary of PMBus optional communication protocols supported by this device.	R Byte	N	Reg			0xE0	33
VOUT_MODE	0x20	Output voltage data format and mantissa exponent. ( $2^{-13}$ )	R Byte	Y	Reg			0x13	34
VOUT_COMMAND	0x21	Servo Target. Nominal DC/DC converter output voltage setpoint.	R/W Word	Y	L16	V	Y	1.0 0x2000	34
VOUT_MAX	0x24	Upper limit on the output voltage the unit can command regardless of any other commands.	R/W Word	Y	L16	V	Y	4.0 0x8000	34
VOUT_MARGIN_HIGH	0x25	Margin high DC/DC converter output voltage setting.	R/W Word	Y	L16	V	Y	1.05 0x219A	34
VOUT_MARGIN_LOW	0x26	Margin low DC/DC converter output voltage setting.	R/W Word	Y	L16	V	Y	0.95 0x1E66	34
VIN_ON	0x35	Input voltage ( $V_{IN\_SNS}$ ) above which power conversion can be enabled.	R/W Word	N	L11	V	Y	10.0 0xD280	34
VIN_OFF	0x36	Input voltage ( $V_{IN\_SNS}$ ) below which power conversion is disabled. All $V_{OUT\_EN}$ pins go off immediately.	R/W Word	N	L11	V	Y	9.0 0xD240	34
VOUT_OV_FAULT_LIMIT	0x40	Output overvoltage fault limit.	R/W Word	Y	L16	V	Y	1.1 0x2333	34
VOUT_OV_FAULT_RESPONSE	0x41	Action to be taken by the device when an output overvoltage fault is detected.	R/W Byte	Y	Reg		Y	0x80	36
VOUT_OV_WARN_LIMIT	0x42	Output overvoltage warning limit.	R/W Word	Y	L16	V	Y	1.075 0x2266	34
VOUT_UV_WARN_LIMIT	0x43	Output undervoltage warning limit.	R/W Word	Y	L16	V	Y	0.925 0x1D9A	34
VOUT_UV_FAULT_LIMIT	0x44	Output undervoltage fault limit. Limit used to determine if TON_MAX_FAULT has been met and the unit is on.	R/W Word	Y	L16	V	Y	0.9 0x1CCD	34
VOUT_UV_FAULT_RESPONSE	0x45	Action to be taken by the device when an output undervoltage fault is detected.	R/W Byte	Y	Reg		Y	0x7F	36
OT_FAULT_LIMIT	0x4F	Overtemperature fault limit.	R/W Word	N	L11	°C	Y	85.0 0xEAA8	35

## PMBus COMMAND SUMMARY

Summary Table

COMMAND NAME	CMD CODE	DESCRIPTION	TYPE	PAGED	DATA FORMAT	UNITS	EEPROM	DEFAULT VALUE FLOAT HEX	REF PAGE
OT_FAULT_RESPONSE	0x50	Action to be taken by the device when an overtemperature fault is detected.	R/W Byte	N	Reg		Y	0xB8	37
OT_WARN_LIMIT	0x51	Overtemperature warning limit.	R/W Word	N	L11	°C	Y	75.0 0xEA58	35
UT_WARN_LIMIT	0x52	Undertemperature warning limit.	R/W Word	N	L11	°C	Y	0 0x8000	35
UT_FAULT_LIMIT	0x53	Undertemperature fault limit.	R/W Word	N	L11	°C	Y	-5.0 0xCD80	35
UT_FAULT_RESPONSE	0x54	Action to be taken by the device when an undertemperature fault is detected.	R/W Byte	N	Reg		Y	0xB8	37
VIN_OV_FAULT_LIMIT	0x55	Input overvoltage fault limit measured at V <sub>IN_SNS</sub> pin	R/W Word	N	L11	V	Y	15.0 0xD3C0	34
VIN_OV_FAULT_RESPONSE	0x56	Action to be taken by the device when an input overvoltage fault is detected.	R/W Byte	N	Reg		Y	0x80	37
VIN_OV_WARN_LIMIT	0x57	Input overvoltage warning limit measured at V <sub>IN_SNS</sub> pin	R/W Word	N	L11	V	Y	14.0 0xD380	34
VIN_UV_WARN_LIMIT	0x58	Input undervoltage warning limit measured at V <sub>IN_SNS</sub> pin.	R/W Word	N	L11	V	Y	0 0x8000	34
VIN_UV_FAULT_LIMIT	0x59	Input undervoltage fault limit measured at V <sub>IN_SNS</sub> pin	R/W Word	N	L11	V	Y	0 0x8000	34
VIN_UV_FAULT_RESPONSE	0x5A	Action to be taken by the device when an input undervoltage fault is detected.	R/W Byte	N	Reg		Y	0x00	37
POWER_GOOD_ON	0x5E	Output voltage at or above which a power good should be asserted.	R/W Word	Y	L16	V	Y	0.96 0x1EB8	34
POWER_GOOD_OFF	0x5F	Output voltage at or below which a power good should be deasserted.	R/W Word	Y	L16	V	Y	0.94 0x1E14	34
TON_DELAY	0x60	Time from CONTROL pin and/or OPERATION command = ON to V <sub>OUT_EN</sub> pin = ON.	R/W Word	Y	L11	ms	Y	1.0 0xBA00	35
TON_RISE	0x61	Time from when the V <sub>OUT_EN</sub> pin goes high until the LTC2978A optionally soft-connects its DAC and begins to servo the output voltage to the desired value.	R/W Word	Y	L11	ms	Y	10.0 0xD280	35
TON_MAX_FAULT_LIMIT	0x62	Maximum time from V <sub>OUT_EN</sub> = ON assertion that an UV condition will be tolerated before a TON_MAX_FAULT condition results.	R/W Word	Y	L11	ms	Y	15.0 0xD3C0	35
TON_MAX_FAULT_RESPONSE	0x63	Action to be taken by the device when a TON_MAX_FAULT event is detected.	R/W Byte	Y	Reg		Y	0xB8	37
TOFF_DELAY	0x64	Time from CONTROL pin and/or OPERATION command = OFF to V <sub>OUT_EN</sub> pin = OFF.	R/W Word	Y	L11	ms	Y	1.0 0xBA00	35
STATUS_BYTE	0x78	One byte summary of the unit's fault condition.	R Byte	Y	Reg			NA	38
STATUS_WORD	0x79	Two byte summary of the unit's fault condition.	R Word	Y	Reg			NA	39
STATUS_VOUT	0x7A	Output voltage fault and warning status.	R Byte	Y	Reg			NA	39



## PMBus COMMAND SUMMARY

Summary Table

COMMAND NAME	CMD CODE	DESCRIPTION	TYPE	PAGED	DATA FORMAT	UNITS	EEPROM	DEFAULT VALUE FLOAT HEX	REF PAGE
STATUS_INPUT	0x7C	Input voltage fault and warning status measured at VIN_SNS pin.	R Byte	N	Reg			NA	40
STATUS_TEMPERATURE	0x7D	Temperature fault and warning status for READ_TEMPERATURE_1.	R Byte	N	Reg			NA	40
STATUS_CML	0x7E	Communication and memory fault and warning status.	R Byte	N	Reg			NA	41
STATUS_MFR_SPECIFIC	0x80	Manufacturer specific fault and state information.	R Byte	Y	Reg			NA	41
READ_VIN	0x88	Input voltage measured at VIN_SNS pin.	R Word	N	L11	V		NA	42
READ_VOUT	0x8B	DC/DC converter output voltage.	R Word	Y	L16	V		NA	42
READ_TEMPERATURE_1	0x8D	Internal junction temperature.	R Word	N	L11	°C		NA	42
PMBUS_REVISION	0x98	PMBus revision supported by this device. Current revision is 1.1.	R Byte	N	Reg			0x11	42
MFR_CONFIG_LTC2978	0xD0	Configuration bits that are channel specific.	R/W Word	Y	Reg		Y	0x0080	43
MFR_CONFIG_ALL_LTC2978	0xD1	Configuration bits that are common to all pages.	R/W Byte	N	Reg		Y	0x7B	44
MFR_FAULTBz0_PROPAGATE	0xD2	Configuration that determines if a channel's faulted off state is propagated to the FAULTB00 and FAULTB10 pins.	R/W Byte	Y	Reg		Y	0x00	45
MFR_FAULTBz1_PROPAGATE	0xD3	Manufacturer configuration that Configuration that determines if a channel's faulted off state is propagated to the FAULTB01 and FAULTB11 pins.	R/W Byte	Y	Reg		Y	0x00	45
MFR_PWRGD_EN	0xD4	Configuration for mapping PWRGD and WDI/RESETB status to the PWRGD pin.	R/W Word	N	Reg		Y	0x0000	46
MFR_FAULTB00_RESPONSE	0xD5	Action to be taken by the device when the FAULTB00 pin is asserted low.	R/W Byte	N	Reg		Y	0x00	47
MFR_FAULTB01_RESPONSE	0xD6	Action to be taken by the device when the FAULTB01 pin is asserted low.	R/W Byte	N	Reg		Y	0x00	47
MFR_FAULTB10_RESPONSE	0xD7	Action to be taken by the device when the FAULTB10 pin is asserted low.	R/W Byte	N	Reg		Y	0x00	47
MFR_FAULTB11_RESPONSE	0xD8	Action to be taken by the device when the FAULTB11 pin is asserted low.	R/W Byte	N	Reg		Y	0x00	47
MFR_VINEN_OV_FAULT_RESPONSE	0xD9	Action to be taken by the VIN_EN pin in response to a VOUT_OV_FAULT.	R/W Byte	N	Reg		Y	0x00	48
MFR_VINEN_UV_FAULT_RESPONSE	0xDA	Action to be taken by the VIN_EN pin in response to a VOUT_UV_FAULT.	R/W Byte	N	Reg		Y	0x00	49
MFR_RETRY_DELAY	0xDB	Retry interval during FAULT retry mode.	R/W Word	N	L11	ms	Y	200.0 0xF320	49
MFR_RESTART_DELAY	0xDC	Delay from actual CONTROL active edge to virtual CONTROL active edge.	R/W Word	N	L11	ms	Y	400.0 0xFB20	50
MFR_VOUT_PEAK	0xDD	Maximum measured value of READ_VOUT.	R Word	Y	L16	V		NA	50
MFR_VIN_PEAK	0xDE	Maximum measured value of READ_VIN.	R Word	N	L11	V		NA	50
MFR_TEMPERATURE_PEAK	0xDF	Maximum measured value of READ_TEMPERATURE_1.	R Word	N	L11	°C		NA	50

2978afb

## PMBus COMMAND SUMMARY

Summary Table

COMMAND NAME	CMD CODE	DESCRIPTION	TYPE	PAGED	DATA FORMAT	UNITS	EEPROM	DEFAULT VALUE FLOAT HEX	REF PAGE
MFR_DAC	0xE0	Manufacturer register that contains the code of the 10-bit DAC.	R/W Word	Y	Reg			0x0000	51
MFR_POWERGOOD_ASSERTION_DELAY	0xE1	Power good output assertion delay.	R/W Word	N	L11	ms	Y	100.0 0xEB20	51
MFR_WATCHDOG_T_FIRST	0xE2	First watchdog timer interval.	R/W Word	N	L11	ms	Y	0 0x8000	51
MFR_WATCHDOG_T	0xE3	Watchdog timer interval.	R/W Word	N	L11	ms	Y	0 0x8000	51
MFR_PAGE_FF_MASK	0xE4	Configuration defining which channels respond to global page commands (PAGE=0xFF).	R/W Byte	N	Reg		Y	0xFF	52
MFR_PADS	0xE5	Current state of selected digital I/O pads.	R Word	N	Reg			N/A	53
MFR_I2C_BASE_ADDRESS	0xE6	Base value of the I <sup>2</sup> C/SMBus address byte.	R/W Byte	N	Reg		Y	0x5C	53
MFR_SPECIAL_ID	0xE7	Manufacturer code for identifying the LTC2978A	R Word	N	Reg		Y	0x0124	53
MFR_SPECIAL_LOT	0xE8	Customer dependent codes that identify the factory programmed user configuration stored in EEPROM. Contact factory for default value.	R Byte	Y	Reg		Y		54
MFR_VOUT_DISCHARGE_THRESHOLD	0xE9	Coefficient used to multiply VOUT_COMMAND in order to determine V <sub>OUT</sub> off threshold voltage.	R/W Word	Y	L11		Y	2.0 0xC200	54
MFR_FAULT_LOG_STORE	0xEA	Command a transfer of the fault log from RAM to EEPROM. This causes the part to behave as if a channel has faulted off.	Send Byte	N				NA	56
MFR_FAULT_LOG_RESTORE	0xEB	Command a transfer of the fault log previously stored in EEPROM back to RAM.	Send Byte	N				NA	56
MFR_FAULT_LOG_CLEAR	0xEC	Initialize the EEPROM block reserved for fault logging and clear any previous fault logging locks.	Send Byte	N				NA	56
MFR_FAULT_LOG_STATUS	0xED	Fault logging status.	R Byte	N	Reg		Y	NA	56
MFR_FAULT_LOG	0xEE	Fault log data bytes. This sequentially retrieved data is used to assemble a complete fault log. 256 Bytes: 0xFF followed by 255 bytes of fault log data.	R Block	N	Reg		Y	NA	57
MFR_COMMON	0xEF	Manufacturer status bits that are common across multiple ADI chips.	R Byte	N	Reg			NA	54
MFR_SPARE_0	0xF7	Scratchpad register.	R/W Word	N	Reg		Y	0x0000	54
MFR_SPARE_1	0xF8	Manufacturer reserved.	R/W Word	N	Reg		Y	NA	54
MFR_SPARE_2	0xF9	Paged scratchpad register.	R/W Word	Y	Reg		Y	0x0000	54
MFR_SPARE_3	0xFA	Manufacturer reserved.	R/W Word	Y	Reg		Y	NA	54
MFR_VOUT_MIN	0xFB	Minimum measured value of READ_VOUT.	R Word	Y	L16	V		NA	55
MFR_VIN_MIN	0xFC	Minimum measured value of READ_VIN.	R Word	N	L11	V		NA	55
MFR_TEMPERATURE_MIN	0xFD	Minimum measured value of READ_TEMPERATURE_1.	R Word	N	L11	°C		NA	55

2978afb

## PMBus COMMAND SUMMARY

### Data Formats

L11	Linear_5s_11s	<p>PMBus data field b[15:0]  Value = <math>Y \cdot 2^N</math>  where <math>N = b[15:11]</math> is a 5-bit two's complement integer and <math>Y = b[10:0]</math> is an 11-bit two's complement integer  Example:  READ_VIN = 10V  For b[15:0] = 0xD280 = 1101_0010_1000_0000b  Value = <math>640 \cdot 2^{-6} = 10</math>  See PMBus Spec Part II: Paragraph 7.1</p>
L16	Linear_16u	<p>PMBus data field b[15:0]  Value = <math>Y \cdot 2^N</math> where <math>Y = b[15:0]</math> is an unsigned integer and <math>N = \text{Vout\_mode\_parameter}</math> is a 5-bit two's complement exponent that is hardwired to -13 decimal.  Example:  VOUT_COMMAND = 4.75V  For b[15:0] = 0x9800 = 1001_1000_0000_0000b  Value = <math>38912 \cdot 2^{-13} = 4.75</math>  See PMBus Spec Part II: Paragraph 8.3.1</p>
Reg	Register	<p>PMBus data field b[15:0] or b[7:0].  Bit field meaning is defined in detailed PMBus Command Register Description.</p>
CF	Custom Format	<p>PMBus data field b[15:0]  Value is defined in detailed PMBus Command Register Description. This is often an unsigned or two's complement integer scaled by an MFR specific constant.</p>

## PMBus COMMAND DESCRIPTION

### OPERATION, MODE AND EEPROM COMMANDS

#### PAGE

The LTC2978A has eight pages that correspond to the eight DC/DC converter channels that can be managed. Each DC/DC converter channel can be uniquely programmed by first setting the appropriate page.

The PAGE command provides the ability to configure, control and monitor multiple outputs on one unit. Setting PAGE = 0xFF allows a simultaneous write to all pages for PMBus commands that support global page programming. The only commands that support PAGE = 0xFF are OPERATION and ON\_OFF\_CONFIG. See MFR\_PAGE\_FF\_MASK for additional options. Reading any paged PMBus register with PAGE = 0xFF returns unpredictable data and will trigger a CML fault.

#### PAGE Data Contents

BIT(S)	SYMBOL	PURPOSE
b[7:0]	Page	Page operation. 0x00: All PMBus commands address channel/page 0. 0x01: All PMBus commands address channel/page 1. • • • 0x07: All PMBus commands address channel/page 7. 0XX: All nonspecified values reserved. 0xFF: A single PMBus write/send to commands that support this mode will simultaneously address all channels/pages with MFR_PAGE_FF_MASK enabled.

## PMBus COMMAND DESCRIPTION

### OPERATION

The OPERATION command is used to turn the unit on and off in conjunction with the CONTROL $n$  pin and ON\_OFF\_CONFIG. This command register responds to the global page command (PAGE=0xFF). The contents and functions of the data byte are shown in the following tables. A minimum  $t_{OFF\_MIN}$  wait time must be observed between OPERATION commands used to turn the unit off and then back on.

#### OPERATION Data Contents (On\_off\_config\_use\_pmbus=1)

SYMBOL	Action	Operation_control[1:0]	Operation_margin[1:0]	Operation_fault[1:0]	Reserved (read only)
BITS		b[7:6]	b[5:4]	b[3:2]	b[1:0]
FUNCTION	Turn off immediately	00	XX	XX	00
	Turn on	10	00	XX	00
	Margin Low (Ignore Faults and Warnings)	10	01	01	00
	Margin Low	10	01	10	00
	Margin High (Ignore Faults and Warnings)	10	10	01	00
	Margin High	10	10	10	00
	Sequence off and margin to nominal	01	00	XX	00
	Sequence off and Margin Low (Ignore Faults and Warnings)	01	01	01	00
	Sequence off and Margin Low	01	01	10	00
	Sequence off and Margin High (Ignore Faults and Warnings)	01	10	01	00
	Sequence off and Margin High	01	10	10	00
	Reserved	All remaining combinations			

#### OPERATION Data Contents (On\_off\_config\_use\_pmbus=0)

SYMBOL	Action	Operation_control[1:0]	Operation_margin[1:0]	Operation_fault[1:0]	Reserved (read only)
BITS		b[7:6]	b[5:4]	b[3:2]	b[1:0]
FUNCTION	Output at Nominal	00, 01 or 10	00	XX	00
	Margin Low (Ignore faults and Warnings)	00, 01 or 10	01	01	00
	Margin Low	00, 01 or 10	01	10	00
	Margin High (Ignore Faults and Warnings)	00, 01 or 10	10	01	00
	Margin High	00, 01 or 10	10	10	00
	Reserved	All remaining combinations			

## PMBus COMMAND DESCRIPTION

### ON\_OFF\_CONFIG

The ON\_OFF\_CONFIG command configures the combination of CONTROL $n$  pin input and PMBus bus commands needed to turn the LTC2978A on/off, including the power-on behavior, as shown in the following table. This command register responds to the global page command (PAGE=0xFF). After the part has initialized, an additional comparator monitors VIN\_SNS. The VIN\_ON threshold must be exceeded before the output power sequencing can begin. After V<sub>IN</sub> is initially applied, the part will typically require t<sub>INIT</sub> time to initialize and begin the TON\_DELAY timer. The readback of voltages and currents may require an additional wait for t<sub>UPDATE\_ADC</sub>. A minimum t<sub>OFF\_MIN</sub> wait time must be observed for any CONTROL pin toggle used to turn the unit off and then back on.

#### ON\_OFF\_CONFIG Data Contents

BITS(S)	SYMBOL	OPERATION
b[7:5]	Reserved	Don't care. Always returns 0.
b[4]	On_off_config_controlled_on	Controls default autonomous power-up operation. 0: Unit powers up regardless of the CONTROL $n$ pin or OPERATION value. Unit always powers up with sequencing. To turn unit on without sequencing, set TON_DELAY = 0. 1: Unit does not power up unless commanded by the CONTROL $n$ pin and/or the OPERATION command on the serial bus. If On_off_config[3:2] = 00, the unit never powers up.
b[3]	On_off_config_use_pmbus	Controls how the unit responds to commands received via the serial bus. 0: Unit ignores the Operation_control[1:0] bits. 1: Unit responds to Operation_control[1:0]. Depending on On_off_config_use_control, the unit may also require the CONTROL $n$ pin to be asserted for the unit to start.
b[2]	On_off_config_use_control	Controls how unit responds to the CONTROL $n$ pin. 0: Unit ignores the CONTROL $n$ pin. 1: Unit requires the CONTROL $n$ pin to be asserted to start the unit. Depending on On_off_config_use_pmbus the OPERATION command may also be required to instruct the device to start.
b[1]	Reserved	Not supported. Always returns 1.
b[0]	On_off_config_control_fast_off	CONTROL $n$ pin turn off action when commanding the unit to turn off 0: Use the programmed TOFF_DELAY. 1: Turn off the output and stop transferring energy as quickly as possible, i.e. pull V <sub>OUT_EN<math>n</math></sub> low immediately. The device does not sink current in order to decrease the output voltage fall time.

### CLEAR\_FAULTS

The CLEAR\_FAULTS command is used to clear any status bits that have been set. This command clears all fault and warning bits in all unpagged status registers, and the paged status registers selected by the current PAGE setting. At the same time, the device negates (clears, releases) its contribution to ALERTB.

The CLEAR\_FAULTS command does not cause a unit that has latched off for a fault condition to restart. See Clearing Latched Faults for more information.

If the fault condition is present after the fault status is cleared, the fault status bit shall be set again and the host notified by the usual means.

Note: This command register does not respond to the global page command (PAGE=0xFF).



## PMBus COMMAND DESCRIPTION

### WRITE\_PROTECT

The WRITE\_PROTECT command provides protection against accidental programming of the LTC2978A command registers. All supported commands may have their parameters read, regardless of the WRITE\_PROTECT setting.

There are two levels of write protection:

- Level 1: Nothing can be changed except the level of write protection itself. Values can be read from all pages. This setting can be stored to EEPROM.
- Level 2: Nothing can be changed except for the level of protection, channel on/off state and clearing of faults. Values can be read from all pages. This setting can be stored to EEPROM.

#### WRITE\_PROTECT Data Contents

BITS(S)	SYMBOL	OPERATION
b[7:0]	Write_protect[7:0]	Level 1: 1000_0000b: Disable all writes except to the WRITE_PROTECT, PAGE, and STORE_USER_ALL commands. Level 2: 0100_0000b: Disable all writes except to the WRITE_PROTECT, PAGE, STORE_USER_ALL, OPERATION, MFR_PAGE_FF_MASK, and CLEAR_FAULTS. 0000_0000b: Enable writes to all commands. xxxx_xxxx b: All other values reserved.

### STORE\_USER\_ALL and RESTORE\_USER\_ALL

STORE\_USER\_ALL, RESTORE\_USER\_ALL commands provide access to User EEPROM space. Once a command is stored in User EEPROM, it will be restored with an explicit restore command or when the part emerges from power-on reset after power is applied. While either of these commands is being processed, the device will NACK I<sup>2</sup>C writes.

STORE\_USER\_ALL. Issuing this command will store all operating memory commands with a corresponding EEPROM memory location. It is recommended that this command not be executed while a unit is enabled since all monitoring is suspended while the operating memory is transferred to EEPROM.

RESTORE\_USER\_ALL. Issuing this command will restore all commands from EEPROM Memory. It is recommended that this command not be executed while a unit is enabled since all monitoring is suspended while the EEPROM is transferred to operating memory, and intermediate values from EEPROM may not be compatible with the values initially stored in operating memory.

### CAPABILITY

The CAPABILITY command provides a way for a host system to determine some key capabilities of the LTC2978A. This one byte command is read only.

#### CAPABILITY Data Contents

BITS(S)	SYMBOL	OPERATION
b[7]	Capability_pec	Hard coded to 1 indicating Packet Error Checking is supported. Reading the Mfr_config_all_pec_en bit will indicate whether PEC is currently required.
b[6]	Capability_scl_max	Hard coded to 1 indicating the maximum supported bus speed is 400kHz.
b[5]	Capability_smb_alert	Hard coded to 1 indicating this device does have an ALERTB pin and does support the SMBus Alert Response Protocol.
b[4:0]	Reserved	Always returns 0.

## PMBus COMMAND DESCRIPTION

### VOUT\_MODE

This command is read only and specifies the mode and exponent for all commands with a L16 data format. See Data Formats table on page 29.

#### VOUT\_MODE Data Contents

BIT(S)	SYMBOL	OPERATION
b[7:5]	Vout_mode_type	Reports linear mode. Hard wired to 000b.
b[4:0]	Vout_mode_parameter	Linear mode exponent. 5-bit two's complement integer. Hardwired to 0x13 (-13 decimal).

### OUTPUT VOLTAGE RELATED COMMANDS

#### *VOUT\_COMMAND, VOUT\_MAX, VOUT\_MARGIN\_HIGH, VOUT\_MARGIN\_LOW, VOUT\_OV\_FAULT\_LIMIT, VOUT\_OV\_WARN\_LIMIT, VOUT\_UV\_WARN\_LIMIT, VOUT\_UV\_FAULT\_LIMIT, POWER\_GOOD\_ON and POWER\_GOOD\_OFF*

These commands use the same format and provide various servo, margining, and supervising limits for a channel's output voltage. When odd channels are configured to measure current, the OV\_WARN\_LIMIT, UV\_WARN\_LIMIT, OV\_FAULT\_LIMIT and UV\_FAULT\_LIMIT commands are not supported.

#### Data Contents

BIT(S)	SYMBOL	OPERATION
b[15:0]	Vout_command[15:0], Vout_max[15:0], Vout_margin_high[15:0], Vout_margin_low[15:0], Vout_ov_fault_limit[15:0], Vout_ov_warn_limit[15:0], Vout_uv_warn_limit[15:0], Vout_uv_fault_limit[15:0], Power_good_on[15:0], Power_good_off[15:0]	These commands relate to output voltage. The data uses the L16 format. Units: V

### INPUT VOLTAGE RELATED COMMANDS

#### *VIN\_ON, VIN\_OFF, VIN\_OV\_FAULT\_LIMIT, VIN\_OV\_WARN\_LIMIT, VIN\_UV\_WARN\_LIMIT and VIN\_UV\_FAULT\_LIMIT*

These commands use the same format and provide voltage supervising limits for the input voltage  $V_{IN\_SNS}$ .

#### Data Contents

BIT(S)	SYMBOL	OPERATION
b[15:0]	Vin_on[15:0], Vin_off[15:0], Vin_ov_fault_limit[15:0], Vin_ov_warn_limit[15:0], Vin_uv_warn_limit[15:0], Vin_uv_fault_limit[15:0]	These commands relate to input voltage. The data uses the L11 format. Units: V.

## PMBus COMMAND DESCRIPTION

### TEMPERATURE RELATED COMMANDS

#### *OT\_FAULT\_LIMIT, OT\_WARN\_LIMIT, UT\_WARN\_LIMIT and UT\_FAULT\_LIMIT*

These commands provide supervising limits for temperature.

##### Data Contents

BIT(S)	SYMBOL	OPERATION
b[15:0]	Ot_fault_limit[15:0], Ot_warn_limit[15:0], Ut_warn_limit[15:0], Ut_fault_limit[15:0]	The data uses the L11 format. Units: °C.

### TIMER LIMITS

#### *TON\_DELAY, TON\_RISE, TON\_MAX\_FAULT\_LIMIT and TOFF\_DELAY*

These commands share the same format and provide sequencing and timer fault and warning delays in ms.

TON\_DELAY sets the amount of time in milliseconds that a channel waits following the start of an ON sequence before its V<sub>OUT\_EN</sub> pin enables a DC/DC converter. This delay is counted using SHARE\_CLK only.

TON\_RISE sets the amount of time in ms that elapses after the power supply has been enabled until the LTC2978A's DAC soft-connects and servos the output voltage to the desired level if Mfr\_dac\_mode = 00b. This delay is counted using SHARE\_CLK only.

TON\_MAX\_FAULT\_LIMIT is the maximum amount of time that the power supply being controlled by the LTC2978A can attempt to power up the output without reaching the VOUT\_UV\_FAULT\_LIMIT. If the output reaches VOUT\_UV\_FAULT\_LIMIT prior to TON\_MAX\_FAULT\_LIMIT, the LTC2978A unmask the VOUT\_UV\_FAULT\_LIMIT threshold. If it does not, then a TON\_MAX\_FAULT is declared. (Note that a value of zero means there is no limit to how long the power supply can attempt to bring up its output voltage.) This delay is counted using SHARE\_CLK only.

TOFF\_DELAY is the amount of time that elapses after the CONTROL<sub>n</sub> pin and/or OPERATION command is deasserted until the channel is disabled (soft-off). This delay is counted using SHARE\_CLK if available, otherwise the internal oscillator is used.

##### Data Contents

BIT(S)	SYMBOL	OPERATION
b[15:0]	Ton_delay[15:0], Ton_rise[15:0], Ton_max_fault_limit[15:0], Toff_delay[15:0],	The data uses the L11 format. The internal timers operate on a 10µs internal clock. The SHARE_CLK pin may be used to synchronize the 10µs timer. Delays are rounded to the nearest 10µs Units: ms. Max value: 655ms

**PMBus COMMAND DESCRIPTION****FAULT RESPONSE FOR VOLTAGES MEASURED BY THE HIGH SPEED SUPERVISOR*****VOUT\_OV\_FAULT\_RESPONSE and VOUT\_UV\_FAULT\_RESPONSE***

The fault response documented here is for voltages that are measured by the high speed supervisor. These voltages are measured over a short period of time and may require a deglitch period. Note that in addition to the response described by these commands, the LTC2978A will also:

- Set the appropriate bit(s) in the STATUS\_BYTE
- Set the appropriate bit(s) in the STATUS\_WORD
- Set the appropriate bit in the corresponding STATUS\_VOUT register, and
- Notify the host by pulling the ALERTB pin low.

Note: Odd numbered channels configured for high resolution ADC measurements (current measurements) will not respond to OV/UV faults or warnings.

**Data Contents**

<b>BIT(S)</b>	<b>SYMBOL</b>	<b>OPERATION</b>
b[7:6]	Vout_ov_fault_response_action, Vout_uv_fault_response_action	Response action: 00b: The unit continues operation without interruption. 01b: The unit continues operating for the delay time specified by bits[2:0] in increments of ts_vs. (See Electrical Characteristics Table, Voltage Supervisor Characteristics section). If the fault is still present at the end of the delay time, the unit shuts down and responds as programmed in the retry setting (bits [5:3]). 1Xb: The device shuts down and responds according to the retry setting in bits [5:3].
b[5:3]	Vout_ov_fault_response_retry, Vout_uv_fault_response_retry	Response retry behavior: 000b: A zero value for the retry setting means that the unit does not attempt to restart. The output remains disabled until the fault is cleared. 001b-111b: The PMBus device attempts to restart continuously, without limitation, at intervals of Mfr_retry_delay, until it is commanded OFF (by the CONTROL pin or OPERATION command or both), bias power is removed, or another fault condition causes the unit to shut down. Changing the value might not take effect until the next off-then-on sequence on that channel.
b[2:0]	Vout_ov_fault_response_delay, Vout_uv_fault_response_delay	This sample count determines the amount of time a unit is to ignore a fault after it is first detected. Use this delay to deglitch fast faults. 000b: The unit turns off immediately. 001b-111b: The unit turns off after b[2:0] samples at the sampling period of ts_vs (12.2µs typical).

## PMBus COMMAND DESCRIPTION

### FAULT RESPONSE FOR VALUES MEASURED BY THE ADC

#### *OT\_FAULT\_RESPONSE, UT\_FAULT\_RESPONSE, VIN\_OV\_FAULT\_RESPONSE and VIN\_UV\_FAULT\_RESPONSE*

The fault response documented here is for values that are measured by the ADC. These values are measured over a longer period of time and are not deglitched. Note that in addition to the response described by these commands, the LTC2978A will also:

- Set the appropriate bit(s) in the STATUS\_BYTE
- Set the appropriate bit(s) in the STATUS\_WORD
- Set the appropriate bit in the corresponding STATUS\_VIN or STATUS\_TEMPERATURE register, and
- Notify the host by pulling the ALERTB pin low.

#### Data Contents

BIT(S)	SYMBOL	OPERATION
b[7:6]	Ot_fault_response_action, Ut_fault_response_action, Vin_ov_fault_response_action, Vin_uv_fault_response_action	Response action: 00b: The unit continues operation without interruption. 01b to 11b: The device shuts down and responds according to the retry setting in bits [5:3].
b[5:3]	Ot_fault_response_retry, Ut_fault_response_retry, Vin_ov_fault_response_retry, Vin_uv_fault_response_retry	Response retry behavior: 000b: A zero value for the retry setting means that the unit does not attempt to restart. The output remains disabled until the fault is cleared. 001b-111b: The PMBus device attempts to restart continuously, without limitation, using Mfr_retry_delay, until it is commanded OFF (by the CONTROL <sub>n</sub> pin or OPERATION command or both), bias power is removed, or another fault condition causes the unit to shut down. Changing the value might not take effect until the next off-then-on sequence on that channel.
b[2:0]	Ot_fault_response_delay, Ut_fault_response_delay, Vin_ov_fault_response_delay, Vin_uv_fault_response_delay	Hard coded to 000b. There is no additional deglitch delay applied to fault detection.

### TIMED FAULT RESPONSE

#### *TON\_MAX\_FAULT\_RESPONSE*

This command defines the LTC2978A response to a TON\_MAX\_FAULT. It may be used to protect against a short-circuited output at start-up. After start-up use VOUT\_UV\_FAULT\_RESPONSE to protect against a short-circuited output.

The device also:

- Sets the HIGH\_BYTE bit in the STATUS\_BYTE,
- Sets the VOUT bit in the STATUS\_WORD,
- Sets the TON\_MAX\_FAULT bit in the STATUS\_VOUT register, and
- Notifies the host by asserting ALERTB.

## PMBus COMMAND DESCRIPTION

### TON\_MAX\_FAULT\_RESPONSE Data Contents

BIT(S)	SYMBOL	OPERATION
b[7:6]	Ton_max_fault_response_action	Response action: 00b: The unit continues operation without interruption. 01b: The unit continues operating for the delay time specified which for this type of fault corresponds to an immediate shutdown. After shutting off, the device responds according to the retry settings in bits [5:3]. 1Xb: The device shuts down and responds according to the retry setting in bits [5:3].
b[5:3]	Ton_max_fault_response_retry	Response retry behavior: 000b: A zero value for the Retry Setting means that the unit does not attempt to restart. The output remains disabled until the fault is cleared. 001b-111b: The PMBus device attempts to restart continuously, without limitation, using Mfr_retry_delay, until it is commanded OFF (by the CONTROL <sub>n</sub> pin or OPERATION command or both), bias power is removed, or another fault condition causes the unit to shut down. Changing the value might not take effect until the next off-then-on sequence on that channel.
b[2:0]	Ton_max_fault_response_delay	Hard coded to 000b. There is no additional deglitch delay applied to fault detection.

### Clearing Latched Faults

When a channel shuts down due to a fault, the off state is latched. This is referred to as a latched fault condition. Latched faults are reset by toggling the CONTROL pin, using the OPERATION or ON\_OFF\_CONFIG command, or removing and reapplying the bias voltage to the V<sub>IN\_SNS</sub> pin. All fault and warning conditions result in the ALERTB pin being asserted low and the corresponding bits being set in the status registers. The CLEAR\_FAULTS command resets the contents of the status registers and de-asserts the ALERTB output, but it does not clear a faulted off state nor allow a channel to turn back on.

After resetting the faults, ALERTB will be de-asserted. If using a CONTROL pin toggle that does not affect all channels, a non-global OPERATION or ON\_OFF\_CONFIG command, or a CLEAR\_FAULTS command, check the Status\_word of all other channels to make sure no additional faults are reported.

## STATUS COMMANDS

### STATUS\_BYTE

The STATUS\_BYTE command returns the summary of the most critical faults or warnings which have occurred, as shown in the following table. STATUS\_BYTE is a subset of STATUS\_WORD and duplicates the same information.

### STATUS\_BYTE Data Contents

BIT(S)	SYMBOL	OPERATION
b[7]	Status_byte_busy	Same as Status_word_busy
b[6]	Status_byte_off	Same as Status_word_off
b[5]	Status_byte_vout_ov	Same as Status_word_vout_ov
b[4]	Status_byte_iout_oc	Same as Status_word_iout_oc
b[3]	Status_byte_vin_uv	Same as Status_word_vin_uv
b[2]	Status_byte_temp	Same as Status_word_temp
b[1]	Status_byte_cml	Same as Status_word_cml
b[0]	Status_byte_high_byte	Same as Status_word_high_byte

## PMBus COMMAND DESCRIPTION

### STATUS\_WORD

The STATUS\_WORD command returns two bytes of information with a summary of the unit's fault condition. Based on the information in these bytes, the host can get more information by reading the appropriate detailed status register.

The low byte of the STATUS\_WORD is the same register as the STATUS\_BYTE command.

#### STATUS\_WORD Data Contents

BIT(S)	SYMBOL	OPERATION
b[15]	Status_word_vout	An output voltage fault or warning has occurred. See STATUS_VOUT.
b[14]	Status_word_iout	Not supported. Always returns 0.
b[13]	Status_word_input	An input voltage fault or warning has occurred. See STATUS_INPUT.
b[12]	Status_word_mfr	A manufacturer specific fault has occurred. See STATUS_MFR_SPECIFIC.
b[11]	Status_word_power_not_good	The PWRGD pin, if enabled, is negated. Power is not good.
b[10]	Status_word_fans	Not supported. Always returns 0.
b[9]	Status_word_other	Not supported. Always returns 0.
b[8]	Status_word_unknown	Not supported. Always returns 0.
b[7]	Status_word_busy	Device busy when PMBus command received. See OPERATION: Processing Commands.
b[6]	Status_word_off	This bit is asserted if the unit is not providing power to the output, regardless of the reason, including simply not being enabled. The off bit is clear if unit is allowed to provide power to the output.
b[5]	Status_word_vout_ov	An output overvoltage fault has occurred.
b[4]	Status_word_iout_oc	Not supported. Always returns 0.
b[3]	Status_word_vin_uv	A $V_{IN}$ undervoltage fault has occurred.
b[2]	Status_word_temp	A temperature fault or warning has occurred. See STATUS_TEMPERATURE.
b[1]	Status_word_cml	A communication, memory or logic fault has occurred. See STATUS_CML.
b[0]	Status_word_high_byte	A fault/warning not listed in b[7:1] has occurred.

### STATUS\_VOUT

The STATUS\_VOUT command returns the summary of the output voltage faults or warnings which have occurred, as shown in the following table:

#### STATUS\_VOUT Data Contents

BIT(S)	SYMBOL	OPERATION
b[7]	Status_vout_ov_fault	Overvoltage fault.
b[6]	Status_vout_ov_warn	Overvoltage warning.
b[5]	Status_vout_uv_warn	Undervoltage warning
b[4]	Status_vout_uv_fault	Undervoltage fault.
b[3]	Status_vout_max_fault	VOUT_MAX fault. An attempt has been made to set the output voltage to a value higher than allowed by the VOUT_MAX command. After being cleared, Status_vout_max_fault will not report additional faults until a channel state transition (off-then-on) has been performed or a valid output voltage, lower than allowed by VOUT_MAX, has been set.
b[2]	Status_vout_ton_max_fault	TON_MAX_FAULT sequencing fault.
b[1]	Status_vout_toff_max_warn	Not supported. Always returns 0.
b[0]	Status_vout_tracking_error	Not supported. Always returns 0.

## PMBus COMMAND DESCRIPTION

### STATUS\_INPUT

The STATUS\_INPUT command returns the summary of the  $V_{IN}$  faults or warnings which have occurred, as shown in the following table:

#### STATUS\_INPUT Data Contents

BIT(S)	SYMBOL	OPERATION
b[7]	Status_input_ov_fault	$V_{IN}$ Overvoltage fault
b[6]	Status_input_ov_warn	$V_{IN}$ Overvoltage warning
b[5]	Status_input_uv_warn	$V_{IN}$ Undervoltage warning
b[4]	Status_input_uv_fault	$V_{IN}$ Undervoltage fault
b[3]	Status_input_off	Unit is off for insufficient input voltage.
b[2]	$I_{IN}$ overcurrent fault	Not supported. Always returns 0.
b[1]	$I_{IN}$ overcurrent warn	Not supported. Always returns 0.
b[0]	PIN overpower warn	Not supported. Always returns 0.

### STATUS\_TEMPERATURE

The STATUS\_TEMPERATURE command returns the summary of the temperature faults or warnings which have occurred, as shown in the following table:

#### STATUS\_TEMPERATURE Data Contents

Bit(s)	Symbol	Operation
b[7]	Status_temperature_ot_fault	Overtemperature fault.
b[6]	Status_temperature_ot_warn	Overtemperature warning.
b[5]	Status_temperature_ut_warn	Undertemperature warning.
b[4]	Status_temperature_ut_fault	Undertemperature fault.
b[3]	Reserved	Reserved. Always returns 0.
b[2]	Reserved	Reserved. Always returns 0.
b[1]	Reserved	Reserved. Always returns 0.
b[0]	Reserved	Reserved. Always returns 0.



## PMBus COMMAND DESCRIPTION

### STATUS\_CML

The STATUS\_CML command returns the summary of the communication, memory and logic faults or warnings which have occurred, as shown in the following table:

#### STATUS\_CML Data Contents

BIT(S)	SYMBOL	OPERATION
b[7]	Status_cml_cmd_fault	Illegal or unsupported command fault has occurred.
b[6]	Status_cml_data_fault	Illegal or unsupported data received.
b[5]	Status_cml_pec_fault	A PEC fault has occurred. Note: PEC checking is always active in the LTC2978A. Any extra byte received before a STOP will set Status_cml_pec_fault unless the extra byte is a matching PEC byte.
b[4]	Status_cml_memory_fault	A fault has occurred in the EEPROM. The CLEAR_FAULTS command will clear this bit, but correct operation should not be assumed until a successful retry of the failing EEPROM access has occurred.
b[3]	Status_cml_processor_fault	Not supported, always returns 0.
b[2]	Reserved	Reserved, always returns 0.
b[1]	Status_cml_pmbus_fault	A communication fault other than ones listed in this table has occurred. This is a catch all category for illegally formed I <sup>2</sup> C/SMBus commands (Example: An address byte with read =1 received immediately after a START).
b[0]	Status_cml_unknown_fault	Not supported, always returns 0.

### STATUS\_MFR\_SPECIFIC

The STATUS\_MFR\_SPECIFIC command returns manufacturer specific status flags. Bits marked CHANNEL = All are not paged. Bits marked STICKY = Yes stay set until a CLEAR\_FAULTS is issued or the channel is commanded on by the user. Bits marked ALERT = Yes pull ALERTB low when the bit is set. Bits marked OFF = Yes indicate that the event can be configured elsewhere to turn the channel off.

#### STATUS\_MFR\_SPECIFIC Data Contents

BIT(S)	SYMBOL	OPERATION	CHANNEL	STICKY	ALERT	OFF
b[7]	Status_mfr_discharge	A V <sub>OUT</sub> discharge fault occurred while attempting to enter the ON state	Current Page	Yes	Yes	Yes
b[6]	Status_mfr_fault1_in	This channel attempted to turn on while the FAULTBz1 pin was asserted low, or this channel has shut down at least once in response to a FAULTBz1 pin asserting low since the last CONTROL <sub>n</sub> pin toggle, OPERATION command ON/OFF cycle or CLEAR_FAULTS command.	Current Page	Yes	Yes	Yes
b[5]	Status_mfr_fault0_in	This channel attempted to turn on while the FAULTBz0 pin was asserted low, or this channel has shut down at least once in response to a FAULTBz0 pin asserting low since the last CONTROL <sub>n</sub> pin toggle, OPERATION command ON/OFF cycle or CLEAR_FAULTS command.	Current Page	Yes	Yes	Yes
b[4]	Status_mfr_servo_target_reached	Servo target has been reached.	Current Page	No	No	No
b[3]	Status_mfr_dac_connected	DAC is connected and driving V <sub>DACP</sub> pin.	Current Page	No	No	No
b[2]	Status_mfr_dac_saturated	A previous servo operation terminated with maximum or minimum DAC value.	Current Page	Yes	No	No
b[1]	Status_mfr_vinen_faulted_off	V <sub>IN_EN</sub> has been deasserted due to a V <sub>OUT</sub> fault.	All	No	No	No
b[0]	Status_mfr_watchdog_fault	A watchdog fault has occurred.	All	Yes	Yes	No

## PMBus COMMAND DESCRIPTION

### ADC MONITORING COMMANDS

#### **READ\_VIN**

This command returns the most recent ADC measured value of the voltage measured at the  $V_{IN\_SNS}$  pin.

##### READ\_VIN Data Contents

BIT(S)	SYMBOL	OPERATION
b[15:0]	Read_vin[15:0]	The data uses the L11 format. Units: V

#### **READ\_VOUT**

This command returns the most recent ADC measured value of the channel's output voltage. When odd channels are configured to measure current, the data contents use the L11 format with units in mV.

##### READ\_VOUT Data Contents

BIT(S)	SYMBOL	OPERATION
b[15:0]	Read_vout[15:0]	The data uses the L16 format. Units: V

##### READ\_VOUT Data Contents—for Odd Channels Configured to Measure Current (Mfr\_config\_adc\_hires = 1)

Bit(s)	Symbol	Operation
b[15:0]	Read_vout[15:0]	The data uses the L11 format. Units: mV

#### **READ\_TEMPERATURE\_1**

This command returns the most recent ADC measured value of junction temperature in °C as determined by the LTC2978A's internal temperature sensor.

##### READ\_TEMPERATURE\_1 Data Contents

BIT(S)	SYMBOL	OPERATION
b[15:0]	Read_temperature_1 [15:0]	The data uses the L11 format. Units: °C.

#### **PMBUS\_REVISION**

The PMBUS\_REVISION command register is read only and reports the LTC2978A compliance to the PMBus standard revision 1.1.

##### PMBUS\_REVISION Data Contents

BIT(S)	SYMBOL	OPERATION
b[7:0]	PMBus_rev	Reports the PMBus standard revision compliance. This is hard-coded to 0x11 for revision 1.1.

## PMBus COMMAND DESCRIPTION

### MANUFACTURER SPECIFIC COMMANDS

#### MFR\_CONFIG\_LTC2978

This command is used to configure various manufacturer specific operating parameters for each channel.

#### MFR\_CONFIG\_LTC2978 Data Contents

BIT(S)	SYMBOL	OPERATION
b[15:12]	Reserved	Don't care. Always returns 0.
b[11]	Mfr_config_fast_servo_off	Disables fast servo when margining or trimming output voltages: 0: fast-servo enabled. 1: fast-servo disabled.
b[10]	Mfr_config_supervisor_resolution	Selects supervisor resolution: 0: high resolution – 4mV/LSB, range for $V_{VSENSEn} - V_{VSENSEm}$ is 0V to 3.8V. 1: low resolution – 8mV/LSB, range for $V_{VSENSEn} - V_{VSENSEm}$ is 0V to 6.0V.
b[9]	Mfr_config_adc_hires	Selects ADC resolution for odd channels. This is typically used to measure current. Ignored for even channels (they always use low resolution). 0: low resolution – 122 $\mu$ V/LSB. 1: high resolution – 15.6 $\mu$ V/LSB.
b[8]	Mfr_config_controln_sel	Selects the active control pin input (CONTROL0 or CONTROL1) for this channel. 0: Select CONTROL0 pin. 1: Select CONTROL1 pin.
b[7]	Mfr_config_servo_continuous	Select whether the UNIT should continuously servo $V_{OUT}$ after it has reached a new margin or nominal target. Only applies when Mfr_config_dac_mode = 00b. 0: Do not continuously servo $V_{OUT}$ after reaching initial target. 1: Continuously servo $V_{OUT}$ to target.
b[6]	Mfr_config_servo_on_warn	Control re-servo on warning feature. Only applies when Mfr_config_dac_mode = 00b and Mfr_config_servo_continuous = 0. 0: Do not allow the unit to re-servo when a $V_{OUT}$ warning threshold is met or exceeded. 1: Allow the unit to re-servo $V_{OUT}$ to nominal target if $V_{OUT} \geq V(V_{out\_ov\_warn\_limit})$ or $V_{OUT} \leq V(V_{out\_uv\_warn\_limit})$ .
b[5:4]	Mfr_config_dac_mode	Determines how DAC is used when channel is in the ON state and TON_RISE has elapsed. 00: Soft-connect (if needed) and servo to target. 01: DAC not connected. 10: DAC connected immediately using value from MFR_DAC command. If this is the configuration after a reset or RESTORE_USER_ALL, MFR_DAC will be undefined and must be written to desired value. 11: DAC is soft-connected. After soft-connect is complete MFR_DAC may be written.
b[3]	Mfr_config_vo_en_wpu_en	$V_{OUT\_EN}$ pin charge-pumped, current-limited pull-up enable. 0: Disable weak pull-up. $V_{OUT\_EN}$ pin driver is three-stated when channel is on. 1: Use weak current-limited pull-up on $V_{OUT\_EN}$ pin when the channel is on. For channels 4-7 this bit is treated as a 0 regardless of its value.
b[2]	Mfr_config_vo_en_wpd_en	$V_{OUT\_EN}$ pin current-limited pull-down enable. 0: Use a fast N-channel device to pull down $V_{OUT\_EN}$ pin when the channel is off for any reason. 1: Use weak current-limited pull-down to discharge $V_{OUT\_EN}$ pin when channel is off due to soft stop by the CONTROL $n$ pin and/or OPERATION command. If the channel is off due to a fault, use the fast pull-down on $V_{OUT\_EN}$ pin. For channels 4-7 this bit is treated as a 0 regardless of its value.
b[1]	Mfr_config_dac_gain	DAC buffer gain. 0: Select DAC buffer gain dac_gain_0 (1.38V full-scale) 1: Select DAC buffer gain dac_gain_1 (2.65V full-scale)

## PMBus COMMAND DESCRIPTION

### MFR\_CONFIG\_LTC2978 Data Contents

BIT(S)	SYMBOL	OPERATION
b[0]	Mfr_config_dac_pol	DAC output polarity. 0: Encodes negative (inverting) DC/DC converter trim input. 1: Encodes positive (noninverting) DC/DC converter trim input.

### MFR\_CONFIG\_ALL\_LTC2978

This command is used to configure parameters that are common to all channels on the IC. They may be set or reviewed from any PAGE setting.

### MFR\_CONFIG\_ALL\_LTC2978 Data Contents

BIT(S)	SYMBOL	OPERATION
b[7]	Mfr_config_all_fault_log_enable	Enable fault logging to EEPROM in response to Fault. 0: Fault logging to EEPROM is disabled 1: Fault logging to EEPROM is enabled
b[6]	Mfr_config_all_vin_on_clr_faults_en	Allow $V_{IN}$ rising above $V_{IN\_ON}$ to clear all latched faults 0: $V_{IN\_ON}$ clear faults feature is disabled 1: $V_{IN\_ON}$ clear faults feature is enabled
b[5]	Mfr_config_all_control1_pol	Selects active polarity of CONTROL1 pin. 0: Active low (pull pin low to start unit) 1: Active high (pull pin high to start unit)
b[4]	Mfr_config_all_control0_pol	Selects active polarity of CONTROL0 pin. 0: Active low (pull pin low to start unit) 1: Active high (pull pin high to start unit)
b[3]	Mfr_config_all_vin_share_enable	Allow this unit to hold SHARE_CLK pin low when $V_{IN}$ has not risen above $V_{IN\_ON}$ or has fallen below $V_{IN\_OFF}$ . When enabled, this unit will also turn all channels off in response to share-clock being held low. 0: SHARE_CLK inhibit is disabled 1: SHARE_CLK inhibit is enabled
b[2]	Mfr_config_all_pec_en	PMBus packet error checking enable. 0: PEC is accepted but not required 1: PEC is required
b[1]	Mfr_config_all_longer_pmbus_timeout	Increase PMBus timeout internal by a factor of 8. Recommended for fault logging. 0: PMBus timeout is not multiplied by a factor of 8 1: PMBus timeout is multiplied by a factor of 8
b[0]	Mfr_config_all_vinen_wpu_dis	$V_{IN\_EN}$ charge-pumped, current-limited pull-up disable. 0: Use weak current-limited pull-up on $V_{IN\_EN}$ after power-up, as long as no faults have forced $V_{IN\_EN}$ off. 1: Disable weak pull-up. $V_{IN\_EN}$ driver is three-stated after power-up as long as no faults have forced $V_{IN\_EN}$ off.

## PMBus COMMAND DESCRIPTION

### *MFR\_FAULTBz0\_PROPAGATE, MFR\_FAULTBz1\_PROPAGATE*

These manufacturer specific commands enable channels that have faulted off to propagate that state to the appropriate fault pin. Faulted off states for pages 0 through 3 can only be propagated to pins FAULTB00 and FAULTB01; this is referred to as zone 0. Faulted off states for pages 4 through 7 can only be propagated to pins FAULTB10 and FAULTB11; this is referred to as zone 1. The z designator in the command name is used to indicate that this command affects different zones depending on the page. See Figure 19.

Note that pulling a fault pin low will have no effect for channels that have MFR\_FAULTBzn\_RESPONSE set to 0. The channel continues operation without interruption. This fault response is called Ignore (0x0) in LTpowerPlay.

#### **MFR\_FAULTBz0\_PROPAGATE Data Content**

BIT(S)	SYMBOL	OPERATION
b[7:1]	Reserved	Don't care. Always returns 0.
b[0]	Mfr_faultbz0_propagate	Enable fault propagation. For pages 0 through 3, zone 0 0: Channel's faulted off state does not assert FAULTB00 low. 1: Channel's faulted off state asserts FAULTB00 low. For pages 4 through 7, zone 1 0: Channel's faulted off state does not assert FAULTB10 low. 1: Channel's faulted off state asserts FAULTB10 low.

#### **MFR\_FAULTBz1\_PROPAGATE Data Content**

BIT(S)	SYMBOL	OPERATION
b[7:1]	Reserved	Don't care. Always returns 0.
b[0]	Mfr_faultbz1_propagate	Enable fault propagation. For pages 0 through 3, zone 0 0: Channel's faulted off state does not assert FAULTB01 low. 1: Channel's faulted off state asserts FAULTB01 low. For pages 4 through 7, zone 1 0: Channel's faulted off state does not assert FAULTB11 low. 1: Channel's faulted off state asserts FAULTB11 low.

**PMBus COMMAND DESCRIPTION****MFR\_PWRGD\_EN**

This command register controls the mapping of the watchdog and channel power good status to the PWRGD pin. Note that odd numbered channels whose ADC is in high res mode do not contribute to power good.

**MFR\_PWRGD\_EN Data Contents**

BIT(S)	SYMBOL	OPERATION
b[15:9]	Reserved	Read only, always returns 0s.
b[8]	Mfr_pwrzd_en_wdog	Watchdog 1 = Watchdog timer not-expired status is ANDed with PWRGD status for any similarly enabled channels to determine when the PWRGD pin gets asserted. 0 = Watchdog timer does not affect the PWRGD pin.
b[7]	Mfr_pwrzd_en_chan7	Channel 7 1 = PWRGD status for this channel is ANDed with PWRGD status for any similarly enabled channels to determine when the PWRGD pin gets asserted. 0 = PWRGD status for this channel does not affect the PWRGD pin.
b[6]	Mfr_pwrzd_en_chan6	Channel 6 1 = PWRGD status for this channel is ANDed with PWRGD status for any similarly enabled channels to determine when the PWRGD pin gets asserted. 0 = PWRGD status for this channel does not affect the PWRGD pin.
b[5]	Mfr_pwrzd_en_chan5	Channel 5 1 = PWRGD status for this channel is ANDed with PWRGD status for any similarly enabled channels to determine when the PWRGD pin gets asserted. 0 = PWRGD status for this channel does not affect the PWRGD pin.
b[4]	Mfr_pwrzd_en_chan4	Channel 4 1 = PWRGD status for this channel is ANDed with PWRGD status for any similarly enabled channels to determine when the PWRGD pin gets asserted. 0 = PWRGD status for this channel does not affect the PWRGD pin.
b[3]	Mfr_pwrzd_en_chan3	Channel 3 1 = PWRGD status for this channel is ANDed with PWRGD status for any similarly enabled channels to determine when the PWRGD pin gets asserted. 0 = PWRGD status for this channel does not affect the PWRGD pin.
b[2]	Mfr_pwrzd_en_chan2	Channel 2 1 = PWRGD status for this channel is ANDed with PWRGD status for any similarly enabled channels to determine when the PWRGD pin gets asserted. 0 = PWRGD status for this channel does not affect the PWRGD pin.
b[1]	Mfr_pwrzd_en_chan1	Channel 1 1 = PWRGD status for this channel is ANDed with PWRGD status for any similarly enabled channels to determine when the PWRGD pin gets asserted. 0 = PWRGD status for this channel does not affect the PWRGD pin.
b[0]	Mfr_pwrzd_en_chan0	Channel 0 1 = PWRGD status for this channel is ANDed with PWRGD status for any similarly enabled channels to determine when the PWRGD pin gets asserted. 0 = PWRGD status for this channel does not affect the PWRGD pin.

## PMBus COMMAND DESCRIPTION

### ***MFR\_FAULTB00\_RESPONSE, MFR\_FAULTB01\_RESPONSE, MFR\_FAULTB10\_RESPONSE and MFR\_FAULTB11\_RESPONSE***

These manufacturer specific commands share the same format and specify the response to assertions of the FAULTB pins. For fault zone 0, MFR\_FAULTB00\_RESPONSE determines whether channels 0 to 3 shut off when the FAULTB00 pin is asserted, and MFR\_FAULTB01\_RESPONSE determines whether channels 0 to 3 shut off when the FAULTB01 pin is asserted. For fault zone 1, MFR\_FAULTB10\_RESPONSE determines whether channels 4 to 7 shut off when the FAULTB10 pin is asserted, and MFR\_FAULTB11\_RESPONSE determines whether channels 4 to 7 shut off when the FAULTB11 pin is asserted. When a channel shuts off in response to a FAULTB pin, the ALERTB pin is asserted low and the appropriate bit is set in the STATUS\_MFR\_SPECIFIC register. For a graphical explanation, see the switches on the left hand side of Figure 19, Channel Fault Management Block Diagram.

#### Data Contents—Fault Zone 0 Response Commands

BIT(S)	SYMBOL	OPERATION
b[7:4]	Reserved	Read only, always returns 0s.
b[3]	Mfr_faultb00_response_chan3, Mfr_faultb01_response_chan3	Channel 3 response. 0: The channel continues operation without interruption. 1: The channel shuts down if the corresponding FAULTB <sub>zn</sub> pin is still asserted after 10μs. When the FAULTB <sub>zn</sub> pin subsequently deasserts, the channel turns back on, honoring TON_DELAY and TON_RISE settings.
b[2]	Mfr_faultb00_response_chan2, Mfr_faultb01_response_chan2	Channel 2 response. 0: The channel continues operation without interruption. 1: The channel shuts down if the corresponding FAULTB <sub>zn</sub> pin is still asserted after 10μs. When the FAULTB <sub>zn</sub> pin subsequently deasserts, the channel turns back on, honoring TON_DELAY and TON_RISE settings.
b[1]	Mfr_faultb00_response_chan1, Mfr_faultb01_response_chan1	Channel 1 response. 0: The channel continues operation without interruption. 1: The channel shuts down if the corresponding FAULTB <sub>zn</sub> pin is still asserted after 10μs. When the FAULTB <sub>zn</sub> pin subsequently deasserts, the channel turns back on, honoring TON_DELAY and TON_RISE settings.
b[0]	Mfr_faultb00_response_chan0, Mfr_faultb01_response_chan0	Channel 0 response. 0: The channel continues operation without interruption. 1: The channel shuts down if the corresponding FAULTB <sub>zn</sub> pin is still asserted after 10μs. When the FAULTB <sub>zn</sub> pin subsequently deasserts, the channel turns back on, honoring TON_DELAY and TON_RISE settings.

#### Data Contents—Fault Zone 1 Response Commands

BIT(S)	SYMBOL	OPERATION
b[7:4]	Reserved	Read only, always returns 0s.
b[3]	Mfr_faultb10_response_chan7, Mfr_faultb11_response_chan7	Channel 7 response. 0: The channel continues operation without interruption. 1: The channel shuts down if the corresponding FAULTB <sub>zn</sub> pin is still asserted after 10μs. When the FAULTB <sub>zn</sub> pin subsequently deasserts, the channel turns back on, honoring TON_DELAY and TON_RISE settings.
b[2]	Mfr_faultb10_response_chan6, Mfr_faultb11_response_chan6	Channel 6 response. 0: The channel continues operation without interruption. 1: The channel shuts down if the corresponding FAULTB <sub>zn</sub> pin is still asserted after 10μs. When the FAULTB <sub>zn</sub> pin subsequently deasserts, the channel turns back on, honoring TON_DELAY and TON_RISE settings.
b[1]	Mfr_faultb10_response_chan5, Mfr_faultb11_response_chan5	Channel 5 response. 0: The channel continues operation without interruption. 1: The channel shuts down if the corresponding FAULTB <sub>zn</sub> pin is still asserted after 10μs. When the FAULTB <sub>zn</sub> pin subsequently deasserts, the channel turns back on, honoring TON_DELAY and TON_RISE settings.
b[0]	Mfr_faultb10_response_chan4, Mfr_faultb11_response_chan4	Channel 4 response. 0: The channel continues operation without interruption. 1: The channel shuts down if the corresponding FAULTB <sub>zn</sub> pin is still asserted after 10μs. When the FAULTB <sub>zn</sub> pin subsequently deasserts, the channel turns back on, honoring TON_DELAY and TON_RISE settings.

2978afb

**PMBus COMMAND DESCRIPTION*****MFR\_VINEN\_OV\_FAULT\_RESPONSE***

This command register determines whether  $V_{OUT}$  overvoltage faults from a given channel cause the  $V_{IN\_EN}$  pin to be pulled low.

**MFR\_VINEN\_OV\_FAULT\_RESPONSE Data Contents**

BIT(S)	SYMBOL	OPERATION
b[7]	Mfr_vinen_ov_fault_response_chan7	Response to channel 7 VOUT_OV_FAULT. 1 = Disable (pull low) $V_{IN\_EN}$ via fast pull-down. 0 = Do not disable $V_{IN\_EN}$ .
b[6]	Mfr_vinen_ov_fault_response_chan6	Response to channel 6 VOUT_OV_FAULT. 1 = Disable (pull low) $V_{IN\_EN}$ via fast pull-down. 0 = Do not disable $V_{IN\_EN}$ .
b[5]	Mfr_vinen_ov_fault_response_chan5	Response to channel 5 VOUT_OV_FAULT. 1 = Disable (pull low) $V_{IN\_EN}$ via fast pull-down. 0 = Do not disable $V_{IN\_EN}$ .
b[4]	Mfr_vinen_ov_fault_response_chan4	Response to channel 4 VOUT_OV_FAULT. 1 = Disable (pull low) $V_{IN\_EN}$ via fast pull-down. 0 = Do not disable $V_{IN\_EN}$ .
b[3]	Mfr_vinen_ov_fault_response_chan3	Response to channel 3 VOUT_OV_FAULT. 1 = Disable (pull low) $V_{IN\_EN}$ via fast pull-down. 0 = Do not disable $V_{IN\_EN}$ .
b[2]	Mfr_vinen_ov_fault_response_chan2	Response to channel 2 VOUT_OV_FAULT. 1 = Disable (pull low) $V_{IN\_EN}$ via fast pull-down. 0 = Do not disable $V_{IN\_EN}$ .
b[1]	Mfr_vinen_ov_fault_response_chan1	Response to channel 1 VOUT_OV_FAULT. 1 = Disable (pull low) $V_{IN\_EN}$ via fast pull-down. 0 = Do not disable $V_{IN\_EN}$ .
b[0]	Mfr_vinen_ov_fault_response_chan0	Response to channel 0 VOUT_OV_FAULT. 1 = Disable (pull low) $V_{IN\_EN}$ via fast pull-down. 0 = Do not disable $V_{IN\_EN}$ .



## PMBus COMMAND DESCRIPTION

### MFR\_VINEN\_UV\_FAULT\_RESPONSE

This command register determines whether  $V_{OUT}$  undervoltage faults from a given channel cause the  $V_{IN\_EN}$  pin to be pulled low.

#### MFR\_VINEN\_UV\_FAULT\_RESPONSE Data Contents

BIT(S)	SYMBOL	OPERATION
b[7]	Mfr_vinen_uv_fault_response_chan7	Response to channel 7 $V_{OUT\_UV\_FAULT}$ . 1 = Disable (pull low) $V_{IN\_EN}$ via fast pull-down. 0 = Do not disable $V_{IN\_EN}$ .
b[6]	Mfr_vinen_uv_fault_response_chan6	Response to channel 6 $V_{OUT\_UV\_FAULT}$ . 1 = Disable (pull low) $V_{IN\_EN}$ via fast pull-down. 0 = Do not disable $V_{IN\_EN}$ .
b[5]	Mfr_vinen_uv_fault_response_chan5	Response to channel 5 $V_{OUT\_UV\_FAULT}$ . 1 = Disable (pull low) $V_{IN\_EN}$ via fast pull-down. 0 = Do not disable $V_{IN\_EN}$ .
b[4]	Mfr_vinen_uv_fault_response_chan4	Response to channel 4 $V_{OUT\_UV\_FAULT}$ . 1 = Disable (pull low) $V_{IN\_EN}$ via fast pull-down. 0 = Do not disable $V_{IN\_EN}$ .
b[3]	Mfr_vinen_uv_fault_response_chan3	Response to channel 3 $V_{OUT\_UV\_FAULT}$ . 1 = Disable (pull low) $V_{IN\_EN}$ via fast pull-down. 0 = Do not disable $V_{IN\_EN}$ .
b[2]	Mfr_vinen_uv_fault_response_chan2	Response to channel 2 $V_{OUT\_UV\_FAULT}$ . 1 = Disable (pull low) $V_{IN\_EN}$ via fast pull-down. 0 = Do not disable $V_{IN\_EN}$ .
b[1]	Mfr_vinen_uv_fault_response_chan1	Response to channel 1 $V_{OUT\_UV\_FAULT}$ . 1 = Disable (pull low) $V_{IN\_EN}$ via fast pull-down. 0 = Do not disable $V_{IN\_EN}$ .
b[0]	Mfr_vinen_uv_fault_response_chan0	Response to channel 0 $V_{OUT\_UV\_FAULT}$ . 1 = Disable (pull low) $V_{IN\_EN}$ via fast pull-down. 0 = Do not disable $V_{IN\_EN}$ .

### MFR\_RETRY\_DELAY

This command determines the retry interval when the LTC2978A is in retry mode in response to a fault condition. The read value of this command always returns what was last written and does not reflect internal limiting.

#### MFR\_RETRY\_DELAY Data Contents

BIT(S)	SYMBOL	OPERATION
b[15:0]	Mfr_retry_delay	The data uses the L11 format. This delay is counted using SHARE_CLK only. Delays are rounded to the nearest 200 $\mu$ s. Units: ms. Max delay is 13.1 sec.

## PMBus COMMAND DESCRIPTION

### ***MFR\_RESTART\_DELAY***

This command sets the minimum off time of a CONTROL initiated restart. If the CONTROL pin is toggled off for at least 10 $\mu$ s then on, all dependent channels are disabled, held off for a time = Mfr\_restart\_delay, then sequenced back on. CONTROL $n$  pin transitions whose OFF time exceeds Mfr\_restart\_delay are not affected by this command. A value of all zeros disables this feature. The read value of this command always returns what was last written and does not reflect internal limiting.

#### **MFR\_RESTART\_DELAY Data Contents**

BIT(S)	SYMBOL	OPERATION
b[15:0]	Mfr_restart_delay	The data uses the L11 format. This delay is counted using SHARE_CLK only. Delays are rounded to the nearest 200 $\mu$ s. Units: ms. Max delay is 13.1 sec.

### ***MFR\_VOUT\_PEAK***

This command returns the maximum ADC measured value of the channel's output voltage. This command is not supported for odd channels that are configured to measure current. This register is reset to 0xF800 (0.0) when the LTC2978A emerges from power-on reset or when a CLEAR\_FAULTS command is executed.

#### **MFR\_VOUT\_PEAK Data Contents**

BIT(S)	SYMBOL	OPERATION
b[15:0]	Mfr_vout_peak[15:0]	The data uses the L16 format. Units: V.

### ***MFR\_VIN\_PEAK***

This command returns the maximum ADC measured value of the input voltage. This register is reset to 0x7C00 ( $-2^{25}$ ) when the LTC2978A emerges from power-on reset or when a CLEAR\_FAULTS command is executed.

#### **MFR\_VIN\_PEAK Data Contents**

BIT(S)	SYMBOL	OPERATION
b[15:0]	Mfr_vin_peak[15:0]	The data uses the L11 format. Units: V

### ***MFR\_TEMPERATURE\_PEAK***

This command returns the maximum ADC measured value of junction temperature in  $^{\circ}$ C as determined by the LTC2978A's internal temperature sensor. This register is reset to 0x7C00 ( $-2^{25}$ ) when the LTC2978A emerges from power-on reset or when a CLEAR\_FAULTS command is executed.

#### **MFR\_TEMPERATURE\_PEAK Data Contents**

BIT(S)	SYMBOL	OPERATION
b[15:0]	Mfr_temperature_peak[15:0]	The data uses the L11 format. Units: $^{\circ}$ C.

## PMBus COMMAND DESCRIPTION

### MFR\_DAC

This command register allows the user to directly program the 10-bit DAC. Manual DAC writes require the channel to be in the ON state, TON\_RISE to have expired and MFR\_CONFIG\_LTC2978 b[5:4] = 10b or 11b. Writing MFR\_CONFIG\_LTC2978 b[5:4] = 10b commands the DAC to hard-connect with the value in Mfr\_dac\_direct\_val. Writing b[5:4] = 11b commands the DAC to soft-connect. Once the DAC has soft-connected, Mfr\_dac\_direct\_val returns the value that allowed the DAC to be connected without perturbing the power supply. MFR\_DAC writes are ignored when MFR\_CONFIG\_LTC2978 b[5:4] = 00b or 01b.

#### MFR\_DAC Data Contents

BIT(S)	SYMBOL	OPERATION
b[15:10]	Reserved	Read only, always returns 0.
b[9:0]	Mfr_dac_direct_val	DAC code value.

### MFR\_POWERGOOD\_ASSERTION\_DELAY

This command register allows the user to program the delay from when the internal power good signal becomes valid until the power good output is asserted. This delay is counted using SHARE\_CLK if available, otherwise the internal oscillator is used. This delay is internally limited to 13.1 seconds, and rounded to the nearest 200µs. The read value of this command always returns what was last written and does not reflect internal limiting.

#### MFR\_POWERGOOD\_ASSERTION\_DELAY Data Contents

BIT(S)	SYMBOL	OPERATION
b[15:0]	Mfr_powergood_assertion_delay	The data uses the L11 format. This delay is counted using SHARE_CLK if available, otherwise the internal oscillator is used. Delays are rounded to the nearest 200µs. Units: ms. Max delay is 13.1 sec.

## WATCHDOG OPERATION

A non zero write to the MFR\_WATCHDOG\_T register will reset the watchdog timer. Low-to-high transitions on the WDI/RESETB pin also reset the watchdog timer. If the timer expires, ALERTB is asserted and the PWRGD output is optionally deasserted and then reasserted after MFR\_PWRGD\_ASSERTION\_DELAY ms. Writing 0 to either the MFR\_WATCH\_DOG\_T or MFR\_WATCHDOG\_T\_FIRST registers will disable the timer.

### MFR\_WATCHDOG\_T\_FIRST and MFR\_WATCHDOG\_T

The MFR\_WATCHDOG\_T\_FIRST register allows the user to program the duration of the first watchdog timer interval following assertion of the PWRGD pin, assuming the PWRGD pin reflects the status of the watchdog timer. If assertion of PWRGD is not conditioned by the watchdog timer's status, then MFR\_WATCHDOG\_T\_FIRST applies to the first timing interval after the timer is enabled. Writing a value of 0ms to the MFR\_WATCHDOG\_T\_FIRST register disables the watchdog timer.

The MFR\_WATCHDOG\_T register allows the user to program watchdog time intervals subsequent to the MFR\_WATCHDOG\_T\_FIRST timing interval. Writing a value of 0ms to the MFR\_WATCHDOG\_T register disables the watchdog timer. A non-zero write to MFR\_WATCHDOG\_T will reset the watchdog timer.

## PMBus COMMAND DESCRIPTION

### MFR\_WATCHDOG\_T\_FIRST and MFR\_WATCHDOG\_T Data Contents

BIT(S)	SYMBOL	OPERATION
b[15:0]	Mfr_watchdog_t_first Mfr_watchdog_t	The data uses the L11 format. These timers operate on an internal clock. The Mfr_watchdog_t timer will align to SHARE_CLK if it is running. Delays are rounded to the nearest 10µs for _t and 1ms for _t_first. Writing a zero value for Y to the Mfr_watchdog_t or Mfr_watchdog_t_first registers will disable the watchdog timer. Units: ms. Max timeout is 0.6 sec for _t and 65 sec for _t_first

### MFR\_PAGE\_FF\_MASK

The MFR\_PAGE\_FF\_MASK command is used to select which channels respond when the global page command (PAGE=0xFF) is in use.

### MFR\_PAGE\_FF\_MASK Data Contents

BIT(S)	SYMBOL	OPERATION
b[7]	Mfr_page_ff_mask_chan7	Channel 7 masking of global page command (PAGE=0xFF) accesses 0 = ignore global page command accesses 1 = fully respond to global page command accesses
b[6]	Mfr_page_ff_mask_chan6	Channel 6 masking of global page command (PAGE=0xFF) accesses 0 = ignore global page command accesses 1 = fully respond to global page command accesses
b[5]	Mfr_page_ff_mask_chan5	Channel 5 masking of global page command (PAGE=0xFF) accesses 0 = ignore global page command accesses 1 = fully respond to global page command accesses
b[4]	Mfr_page_ff_mask_chan4	Channel 4 masking of global page command (PAGE=0xFF) accesses 0 = ignore global page command accesses 1 = fully respond to global page command accesses
b[3]	Mfr_page_ff_mask_chan3	Channel 3 masking of global page command (PAGE=0xFF) accesses 0 = ignore global page command accesses 1 = fully respond to global page command accesses
b[2]	Mfr_page_ff_mask_chan2	Channel 2 masking of global page command (PAGE=0xFF) accesses 0 = ignore global page command accesses 1 = fully respond to global page command accesses
b[1]	Mfr_page_ff_mask_chan1	Channel 1 masking of global page command (PAGE=0xFF) accesses 0 = ignore global page command accesses 1 = fully respond to global page command accesses
b[0]	Mfr_page_ff_mask_chan0	Channel 0 masking of global page command (PAGE=0xFF) accesses 0 = ignore global page command accesses 1 = fully respond to global page command accesses

## PMBus COMMAND DESCRIPTION

### MFR\_PADS

The MFR\_PADS command provides read only access to slow frequency digital pads (pins). The input values presented in bits[9:0] are before any deglitching logic.

#### MFR\_PADS Data Contents

BIT(S)	SYMBOL	OPERATION
b[15]	Mfr_pads_pwrgrd_drive	0 = PWRGD pad is being driven low by this chip 1 = PWRGD pad is not being driven low by this chip
b[14]	Mfr_pads_alertb_drive	0 = ALERTB pad is being driven low by this chip 1 = ALERTB pad is not being driven low by this chip
b[13:10]	Mfr_pads_faultb_drive[3:0]	Bit[3] used for FAULTB00 pad, bit[2] used for FAULTB01 pad, bit[1] used for FAULTB10 pad, bit[0] used for FAULTB11 pad as follows: 0 = FAULTBzn pad is being driven low by this chip 1 = FAULTBzn pad is not being driven low by this chip
b[9:8]	Mfr_pads_asel1[1:0]	11: Logic high detected on ASEL1 input pad 10: ASEL1 input pad is floating 01: Reserved 00: Logic low detected on ASEL1 input pad
b[7:6]	Mfr_pads_asel0[1:0]	11: Logic high detected on ASELO input pad 10: ASELO input pad is floating 01: Reserved 00: Logic low detected on ASELO input pad
b[5]	Mfr_pads_control1	1: Logic high detected on CONTROL1 pad 0: Logic low detected on CONTROL1 pad
b[4]	Mfr_pads_control0	1: Logic high detected on CONTROL0 pad 0: Logic low detected on CONTROL0 pad
b[3:0]	Mfr_pads_faultb[3:0]	Bit[3] used for FAULTB00 pad, bit[2] used for FAULTB01 pad, bit[1] used for FAULTB10 pad, bit[0] used for FAULTB11 pad as follows: 1: Logic high detected on FAULTBzn pad 0: Logic low detected on FAULTBzn pad

### MFR\_I2C\_BASE\_ADDRESS

The MFR\_I2C\_BASE\_ADDRESS command determines the base value for the I<sup>2</sup>C/SMBus address byte. Offsets of 0 to 9 are added to this base address to make the device I<sup>2</sup>C/SMBus address. The part responds to the device address.

#### MFR\_I2C\_BASE\_ADDRESS Data Contents

BIT(S)	SYMBOL	OPERATION
b[7]	Reserved	Read only, always returns 0.
b[6:0]	i2c_base_address	This 7-bit value determines the base value of the 7-bit I <sup>2</sup> C/SMBus address. See Operation Section: Device Address.

### MFR\_SPECIAL\_ID

This register contains the manufacturer ID for the LTC2978A.

#### MFR\_SPECIAL\_ID Data Contents

BIT(S)	SYMBOL	OPERATION
b[15:0]	Mfr_special_id	Read only, always returns 0x0124.

## PMBus COMMAND DESCRIPTION

### MFR\_SPECIAL\_LOT

These paged registers contain information that identifies the user configuration that was programmed at the factory.

#### MFR\_SPECIAL\_LOT Data Contents

BIT(S)	SYMBOL	OPERATION
b[7:0]	Mfr_special_lot	Contains the ADI default special lot number. Contact the factory to request a custom factory programmed user configuration and special lot number.

### MFR\_VOUT\_DISCHARGE\_THRESHOLD

This register contains the coefficient that multiplies VOUT\_COMMAND in order to determine the OFF threshold voltage for the associated output. If the output voltage has not decayed below MFR\_VOUT\_DISCHARGE\_THRESHOLD • VOUT\_COMMAND prior to the channel being commanded to enter/re-enter the ON state, the Status\_mfr\_discharge bit in the STATUS\_MFR\_SPECIFIC register will be set and the ALERTB pin will be asserted low. In addition, the channel will not enter the ON state until the output has decayed below its OFF threshold voltage. Setting this to a value greater than 1.0 effectively disables DISCHARGE\_THRESHOLD checking, allowing the channel to turn back on even if it has not decayed at all.

Other channels can be held off if a particular output has failed to discharge by using the bidirectional FAULTBzn pins (refer to the MFR\_FAULTBzn\_RESPONSE and MFR\_FAULTBzn\_PROPAGATE registers).

#### MFR\_VOUT\_DISCHARGE\_THRESHOLD Data Contents

BIT(S)	SYMBOL	OPERATION
b[15:0]	Mfr_vout_discharge_threshold	The data uses the L11 format. Units: Dimensionless, this register contains a coefficient.

### MFR\_COMMON

This command returns status information for the share-clock pin (SHARE\_CLK) and the write-protect pin (WP).

#### MFR\_COMMON Data Contents

BIT(S)	SYMBOL	OPERATION
b[7:2]	Reserved	Read only, always returns 0s
b[1]	Mfr_common_share_clk	Returns status of share-clock pin 1: Share-clock pin is being held low 0: Share-clock pin is active
b[0]	Mfr_common_write_protect	Returns status of write-protect pin 1: Write-protect pin is high 0: Write-protect pin is low

### MFR\_SPARE\_0, MFR\_SPARE\_1, MFR\_SPARE\_2, MFR\_SPARE\_3

These registers are provided as user scratchpad and additional manufacturer reserved locations.

MFR\_SPARE\_1 and MFR\_SPARE\_3 are all reserved for manufacturer use. Such uses include manufacturer traceability information and LTpowerPlay features like the CRC calculation and storage for user EEPROM configurations.

MFR\_SPARE\_0 and MFR\_SPARE\_2 are available for user scratchpad use. These 18 bytes (1 unpagged word plus 8 paged words) might be used for traceability or revision information such as serial number, board model number, assembly location, or assembly date.

## PMBus COMMAND DESCRIPTION

All MFR\_SPARE registers may be stored and recalled from EEPROM using the STORE\_USER\_ALL and RESTORE\_USER\_ALL commands.

### MFR\_VOUT\_MIN

This command returns the minimum ADC measured value of the channel's output voltage. This register is reset to 0xFFFF (7.999) when the LTC2978A emerges from power-on reset or when a CLEAR\_FAULTS command is executed. When odd channels are configured to measure current, this command is not supported. Updates are disabled when undervoltage detection is disabled, such as when Margin Low (Ignore Faults and Warnings) is enabled.

#### MFR\_VOUT\_MIN Data Contents

BIT(S)	SYMBOL	OPERATION
b[15:0]	Mfr_vout_min	The data uses the L16 format. Units: V.

### MFR\_VIN\_MIN

This command returns the minimum ADC measured value of the input voltage. This register is reset to 0x7BFF (approximately  $2^{25}$ ) when the LTC2978A emerges from power-on reset or when a CLEAR\_FAULTS command is executed. Updates are disabled when unit is off for insufficient input voltage.

#### MFR\_VIN\_MIN Data Contents

BIT(S)	SYMBOL	OPERATION
b[15:0]	Mfr_vin_min	The data uses the L11 format. Units: V.

### MFR\_TEMPERATURE\_MIN

This command returns the minimum ADC measured value of junction temperature in °C as determined by the LTC2978A's internal temperature sensor. This register is reset to 0x7BFF (approximately  $2^{25}$ ) when the LTC2978A emerges from power-on reset or when a CLEAR\_FAULTS command is executed.

#### MFR\_TEMPERATURE\_MIN Data Contents

BIT(S)	SYMBOL	OPERATION
b[15:0]	Mfr_temperature_min	The data uses the L11 format. Units: °C.

## FAULT LOG OPERATION

A conceptual diagram of the fault log is shown in Figure 13. The fault log provides black box capability to the LTC2978A. During normal operation, the contents of the status registers, the output voltage/current readings, temperature readings as well as peak and min values of these quantities are stored in a continuously updated buffer in RAM. You can think of the operation as being similar to a strip chart recorder. When a fault occurs, the contents are written into EEPROM for nonvolatile storage. The EEPROM fault log is then locked. The part can be powered down with the fault log being available for reading at a later time.

**PMBus COMMAND DESCRIPTION**

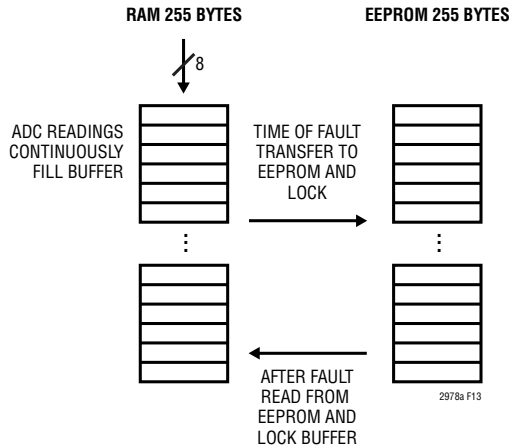

**Figure 13. Fault Log Conceptual Diagram**

***MFR\_FAULT\_LOG\_STORE***

This command allows the user to transfer data from the RAM buffer to EEPROM.

***MFR\_FAULT\_LOG\_RESTORE***

This command allows the user to transfer a copy of the fault-log data from the EEPROM to the RAM buffer. After a restore the RAM buffer is locked until a successful MFR\_FAULT\_LOG read or MFR\_FAULT\_LOG\_CLEAR.

***MFR\_FAULT\_LOG\_CLEAR***

This command initializes the EEPROM block reserved for fault logging. Any previous fault log stored in EEPROM will be erased by this operation and logging of the fault log RAM to EEPROM will be enabled. Make sure that Mfr\_fault\_log\_status\_ram = 0 before issuing the MFR\_FAULT\_LOG\_CLEAR command.

***MFR\_FAULT\_LOG\_STATUS***

Read only. This register is used to manage fault log events.

Mfr\_fault\_log\_status\_eeprom is set after a MFR\_FAULT\_LOG\_STORE command or a faulted-off event triggers a transfer of the fault log from RAM to EEPROM. This bit is cleared by a MFR\_FAULT\_LOG\_CLEAR command.

Mfr\_fault\_log\_status\_ram is set after a MFR\_FAULT\_LOG\_RESTORE to indicate that the data in the RAM has been restored from EEPROM and not yet read using a MFR\_FAULT\_LOG command. This bit is cleared only by a successful execution of an MFR\_FAULT\_LOG command, or by a successful execution of an MFR\_FAULT\_LOG\_CLEAR command.

**MFR\_FAULT\_LOG\_STATUS Data Contents**

BIT(S)	SYMBOL	OPERATION
b[1]	Mfr_fault_log_status_ram	Fault log RAM status: 0: The fault log RAM allows updates. 1: The fault log RAM is locked until the next Mfr_fault_log read.
b[0]	Mfr_fault_log_status_eeprom	Fault log EEPROM status: 0: The transfer of the fault log RAM to the EEPROM is enabled. 1: The transfer of the fault log RAM to the EEPROM is inhibited.



## PMBus COMMAND DESCRIPTION

### MFR\_FAULT\_LOG

Read only. This 2040-bit (255 byte) data block contains a copy of the RAM buffer fault log. The RAM buffer is continuously updated after each ADC conversion as long as Mfr\_fault\_log\_status\_ram is clear.

With Mfr\_config\_all\_fault\_log\_enable = 1 and Mfr\_fault\_log\_status\_eeprom = 0, the RAM buffer is transferred to EEPROM whenever an LTC2978A fault causes a channel to latch off or a MFR\_FAULT\_LOG\_STORE command is received.

Mfr\_fault\_log\_status\_eeprom is set high after the RAM buffer is transferred to EEPROM and not cleared until a MFR\_FAULT\_LOG\_CLEAR is received, even if the LTC2978A is reset or powered down. Fault log EEPROM transfers are not initiated as a result of Status\_mfr\_discharge events.

During a MFR\_FAULT\_LOG read, data is returned as defined by the following table. The fault log data is partitioned into two sections. The first section is referred to as the preamble and contains the Position-last pointer, time information and peak and minimum values. The second section contains a chronological record of telemetry and requires Position-last for proper interpretation. The fault log stores approximately 0.5 seconds of telemetry. To prevent timeouts during block reads, it is recommended that Mfr\_config\_all\_longer\_pmbus\_timeout be set to 1.

Table 2. Data Block Contents

DATA	BYTE*	DESCRIPTION
Position_last[7:0]	0	Position of fault log pointer when fault occurred.
SharedTime[7:0]	1	41-bit share-clock counter value when fault occurred. Counter LSB is in 200µs increments. This counter is cleared at power-up or after the LTC2978A is reset
SharedTime[15:8]	2	
SharedTime[23:16]	3	
SharedTime[31:24]	4	
SharedTime[39:32]	5	
SharedTime[40]	6	
Mfr_vout_peak0[7:0]	7	
Mfr_vout_peak0[15:8]	8	
Mfr_vout_min0[7:0]	9	
Mfr_vout_min0[15:8]	10	
Mfr_vout_peak1[7:0]	11	
Mfr_vout_peak1[15:8]	12	
Mfr_vout_min1[7:0]	13	
Mfr_vout_min1[15:8]	14	
Mfr_vin_peak[7:0]	15	
Mfr_vin_peak[15:8]	16	
Mfr_vin_min[7:0]	17	
Mfr_vin_min[15:8]	18	
Mfr_vout_peak2[7:0]	19	
Mfr_vout_peak2[15:8]	20	
Mfr_vout_min2[7:0]	21	
Mfr_vout_min2[15:8]	22	
Mfr_vout_peak3[7:0]	23	
Mfr_vout_peak3[15:8]	24	
Mfr_vout_min3[7:0]	25	
Mfr_vout_min3[15:8]	26	
Mfr_temp_peak[7:0]	27	
Mfr_temp_peak[15:8]	28	
Mfr_temp_min[7:0]	29	
Mfr_temp_min[15:8]	30	
Mfr_vout_peak4[7:0]	31	
Mfr_vout_peak4[15:8]	32	
Mfr_vout_min4[7:0]	33	
Mfr_vout_min4[15:8]	34	
Mfr_vout_peak5[7:0]	35	
Mfr_vout_peak5[15:8]	36	
Mfr_vout_min5[7:0]	37	
Mfr_vout_min5[15:8]	38	
Mfr_vout_peak6[7:0]	39	
Mfr_vout_peak6[15:8]	40	
Mfr_vout_min6[7:0]	41	
Mfr_vout_min6[15:8]	42	

## PMBus COMMAND DESCRIPTION

**Table 2. Data Block Contents**

DATA	BYTE*	DESCRIPTION
Mfr_vout_peak7[7:0]	43	
Mfr_vout_peak7[15:8]	44	
Mfr_vout_min7[7:0]	45	
Mfr_vout_min7[15:8]	46	
		47 bytes for preamble
Fault_log [Position_last]	47	
Fault_log	48	
.		
.		
.		
Fault_log	237	Last Valid Byte
Reserved	238-254	
		Number of loops (238-47)/40 = 4.8

\*Note: PMBus data byte numbers start at 1 rather than 0. Position\_last is the first byte returned after BYTE COUNT = 0xFF. See block read protocol.

The data returned between bytes 47 and 237 of the previous table is interpreted using Position\_last and the following table. The key to identifying byte 47 is to locate the DATA corresponding to POSITION = Position\_last in the next table. Subsequent bytes are identified by decrementing the value of POSITION. For example: If Position\_last = 9 then the first data returned in byte position 47 of a block read is Read\_vin[15:8] followed by Read\_vin[7:0] followed by Status\_mfr of page 1. See Table 3.

**Table 3. Interpreting Cyclical Loop**

POSITION	DATA
0	Read_vout0[7:0]
1	Read_vout0[15:8]
2	Status_vout0
3	Status_mfr0
4	Read_vout1[7:0]
5	Read_vout1[15:8]
6	Status_vout1
7	Status_mfr1
8	Read_vin[7:0]
9	Read_vin[15:8]
10	Status_vin
11	Reserved
12	Read_vout2[7:0]
13	Read_vout2[15:8]
14	Status_vout2
15	Status_mfr2
16	Read_vout3[7:0]

**Table 3. Interpreting Cyclical Loop**

POSITION	DATA
17	Read_vout3[15:8]
18	Status_vout3
19	Status_mfr3
20	Read_temperature_1[7:0]
21	Read_temperature_1[15:8]
22	Status_temp
23	Reserved
24	Read_vout4[7:0]
25	Read_vout4[15:8]
26	Status_vout4
27	Status_mfr4
28	Read_vout5[7:0]
29	Read_vout5[15:8]
30	Status_vout5
31	Status_mfr5
32	Read_vout6[7:0]
33	Read_vout6[15:8]
34	Status_vout6
35	Status_mfr6
36	Read_vout7[7:0]
37	Read_vout7[15:8]
38	Status_vout7
39	Status_mfr7
	Total Bytes =40

The following table fully decodes a sample fault log read to help clarify the cyclical nature of the operation.

**MFR\_FAULT\_LOG DATA BLOCK CONTENTS**

PREAMBLE INFORMATION				
BYTE NUMBER DECIMAL	BYTE NUMBER HEX		DATA	DESCRIPTION
0	00		Position_last[7:0] = 9	Position of Fault-Log Pointer When Fault Occurred.
1	01		SharedTime[7:0]	41-Bit Share-Clock Counter Value When Fault Occurred. Counter LSB Is in 200µs Increments.
2	02		SharedTime[15:8]	
3	03		SharedTime[23:16]	
4	04		SharedTime[31:24]	

## PMBus COMMAND DESCRIPTION

BYTE NUMBER DECIMAL	BYTE NUMBER HEX	DATA	DESCRIPTION
5	05	SharedTime[39:32]	
6	06	SharedTime[40]	
7	07	Mfr_vout_peak0[7:0]	
8	08	Mfr_vout_peak0[15:8]	
9	09	Mfr_vout_min0[7:0]	
10	0A	Mfr_vout_min0[15:8]	
11	0B	Mfr_vout_peak1[7:0]	
12	0C	Mfr_vout_peak1[15:8]	
13	0D	Mfr_vout_min1[7:0]	
14	0E	Mfr_vout_min1[15:8]	
15	0F	Mfr_vin_peak[7:0]	
16	10	Mfr_vin_peak[15:8]	
17	11	Mfr_vin_min[7:0]	
18	12	Mfr_vin_min[15:8]	
19	13	Mfr_vout_peak2[7:0]	
20	14	Mfr_vout_peak2[15:8]	
21	15	Mfr_vout_min2[7:0]	
22	16	Mfr_vout_min2[15:8]	
23	17	Mfr_vout_peak3[7:0]	
24	18	Mfr_vout_peak3[15:8]	
25	19	Mfr_vout_min3[7:0]	
26	1A	Mfr_vout_min3[15:8]	
27	1B	Mfr_temp_peak[7:0]	
28	1C	Mfr_temp_peak[15:8]	
29	1D	Mfr_temp_min[7:0]	
30	1E	Mfr_temp_min[15:8]	
31	1F	Mfr_vout_peak4[7:0]	
32	20	Mfr_vout_peak4[15:8]	
33	21	Mfr_vout_min4[7:0]	
34	22	Mfr_vout_min4[15:8]	
35	23	Mfr_vout_peak5[7:0]	
36	24	Mfr_vout_peak5[15:8]	
37	25	Mfr_vout_min5[7:0]	
38	26	Mfr_vout_min5[15:8]	
39	27	Mfr_vout_peak6[7:0]	
40	28	Mfr_vout_peak6[15:8]	
41	29	Mfr_vout_min6[7:0]	
42	2A	Mfr_vout_min6[15:8]	
43	2B	Mfr_vout_peak7[7:0]	

BYTE NUMBER DECIMAL	BYTE NUMBER HEX	DATA	DESCRIPTION
44	2C	Mfr_vout_peak7[15:8]	
45	2D	Mfr_vout_min7[7:0]	
46	2E	Mfr_vout_min7[15:8]	End of Preamble

### CYCLICAL DATA LOOPS

BYTE NUMBER DECIMAL	BYTE NUMBER HEX	LOOP BYTE NUMBER DECIMAL	DATA LOOP 0	40 BYTES PER LOOP
47	2F	9	Read_vin[15:8]	Position_last
48	30	8	Read_vin[7:0]	
49	31	7	Status_mfr1	
50	32	6	Status_vout1	
51	33	5	Read_vout1[15:8]	
52	34	4	Read_vout1[7:0]	
53	35	3	Status_mfr0	
54	36	2	Status_vout0	
55	37	1	Read_vout0[15:8]	
56	38	0	Read_vout0[7:0]	

BYTE NUMBER DECIMAL	BYTE NUMBER HEX	LOOP BYTE NUMBER DECIMAL	DATA LOOP 1	40 BYTES PER LOOP
57	39	39	Status_mfr7	
58	3A	38	Status_vout7	
59	3B	37	Read_vout7[15:8]	
60	3C	36	Read_vout7[7:0]	
61	3D	35	Status_mfr6	
62	3E	34	Status_vout6	
63	3F	33	Read_vout6[15:8]	
64	40	32	Read_vout6[7:0]	
65	41	31	Status_mfr5	
66	42	30	Status_vout5	
67	43	29	Read_vout5[15:8]	
68	44	28	Read_vout5[7:0]	
69	45	27	Status_mfr4	
70	46	26	Status_vout4	
71	47	25	Read_vout4[15:8]	
72	48	24	Read_vout4[7:0]	
73	49	23	Reserved	
74	4A	22	Status_temp	

## PMBus COMMAND DESCRIPTION

BYTE NUMBER DECIMAL	BYTE NUMBER HEX	LOOP BYTE NUMBER DECIMAL	DATA LOOP 1	40 BYTES PER LOOP
75	4B	21	Read_temperature_1[15:8]	
76	4C	20	Read_temperature_1[7:0]	
77	4D	19	Status_mfr3	
78	4E	18	Status_vout3	
79	4F	17	Read_vout3[15:8]	
80	50	16	Read_vout3[7:0]	
81	51	15	Status_mfr2	
82	52	14	Status_vout2	
83	53	13	Read_vout2[15:8]	
84	54	12	Read_vout2[7:0]	
85	55	11	Reserved	
86	56	10	Status_vin	
87	57	9	Read_vin[15:8]	
88	58	8	Read_vin[7:0]	
89	59	7	Status_mfr1	
90	5A	6	Status_vout1	
91	5B	5	Read_vout1[15:8]	
92	5C	4	Read_vout1[7:0]	
93	5D	3	Status_mfr0	
94	5E	2	Status_vout0	
95	5F	1	Read_vout0[15:8]	
96	60	0	Read_vout0[7:0]	

BYTE NUMBER DECIMAL	BYTE NUMBER HEX	LOOP BYTE NUMBER DECIMAL	DATA LOOP 2	40 BYTES PER LOOP
97	61	39	Status_mfr7	
98	62	38	Status_vout7	
99	63	37	Read_vout7[15:8]	
100	64	36	Read_vout7[7:0]	
101	65	35	Status_mfr6	
102	66	34	Status_vout6	
103	67	33	Read_vout6[15:8]	
104	68	32	Read_vout6[7:0]	
105	69	31	Status_mfr5	
106	6A	30	Status_vout5	
107	6B	29	Read_vout5[15:8]	
108	6C	28	Read_vout5[7:0]	

BYTE NUMBER DECIMAL	BYTE NUMBER HEX	LOOP BYTE NUMBER DECIMAL	DATA LOOP 2	40 BYTES PER LOOP
109	6D	27	Status_mfr4	
110	6E	26	Status_vout4	
111	6F	25	Read_vout4[15:8]	
112	70	24	Read_vout4[7:0]	
113	71	23	Reserved	
114	72	22	Status_temp	
115	73	21	Read_temperature_1[15:8]	
116	74	20	Read_temperature_1[7:0]	
117	75	19	Status_mfr3	
118	76	18	Status_vout3	
119	77	17	Read_vout3[15:8]	
120	78	16	Read_vout3[7:0]	
121	79	15	Status_mfr2	
122	7A	14	Status_vout2	
123	7B	13	Read_vout2[15:8]	
124	7C	12	Read_vout2[7:0]	
125	7D	11	Reserved	
126	7E	10	Status_vin	
127	7F	9	Read_vin[15:8]	
128	80	8	Read_vin[7:0]	
129	81	7	Status_mfr1	
130	82	6	Status_vout1	
131	83	5	Read_vout1[15:8]	
132	84	4	Read_vout1[7:0]	
133	85	3	Status_mfr0	
134	86	2	Status_vout0	
135	87	1	Read_vout0[15:8]	
136	88	0	Read_vout0[7:0]	

BYTE NUMBER DECIMAL	BYTE NUMBER HEX	LOOP BYTE NUMBER DECIMAL	DATA LOOP 3	40 BYTES PER LOOP
137	89	39	Status_mfr7	
138	8A	38	Status_vout7	
139	8B	37	Read_vout7[15:8]	
140	8C	36	Read_vout7[7:0]	
141	8D	35	Status_mfr6	

## PMBus COMMAND DESCRIPTION

BYTE NUMBER DECIMAL	BYTE NUMBER HEX	LOOP BYTE NUMBER DECIMAL	DATA LOOP 3	40 BYTES PER LOOP
142	8E	34	Status_vout6	
143	8F	33	Read_vout6[15:8]	
144	90	32	Read_vout6[7:0]	
145	91	31	Status_mfr5	
146	92	30	Status_vout5	
147	93	29	Read_vout5[15:8]	
148	94	28	Read_vout5[7:0]	
149	95	27	Status_mfr4	
150	96	26	Status_vout4	
151	97	25	Read_vout4[15:8]	
152	98	24	Read_vout4[7:0]	
153	99	23	Reserved	
154	9A	22	Status_temp	
155	9B	21	Read_temperature_1[15:8]	
156	9C	20	Read_temperature_1[7:0]	
157	9D	19	Status_mfr3	
158	9E	18	Status_vout3	
159	9F	17	Read_vout3[15:8]	
160	A0	16	Read_vout3[7:0]	
161	A1	15	Status_mfr2	
162	A2	14	Status_vout2	
163	A3	13	Read_vout2[15:8]	
164	A4	12	Read_vout2[7:0]	
165	A5	11	Reserved	
166	A6	10	Status_vin	
167	A7	9	Read_vin[15:8]	
168	A8	8	Read_vin[7:0]	
169	A9	7	Status_mfr1	
170	AA	6	Status_vout1	
171	AB	5	Read_vout1[15:8]	
172	AC	4	Read_vout1[7:0]	
173	AD	3	Status_mfr0	
174	AE	2	Status_vout0	
175	AF	1	Read_vout0[15:8]	
176	B0	0	Read_vout0[7:0]	

BYTE NUMBER DECIMAL	BYTE NUMBER HEX	LOOP BYTE NUMBER DECIMAL	DATA LOOP 4	40 BYTES PER LOOP
177	B1	39	Status_mfr7	
178	B2	38	Status_vout7	
179	B3	37	Read_vout7[15:8]	
180	B4	36	Read_vout7[7:0]	
181	B5	35	Status_mfr6	
182	B6	34	Status_vout6	
183	B7	33	Read_vout6[15:8]	
184	B8	32	Read_vout6[7:0]	
185	B9	31	Status_mfr5	
186	BA	30	Status_vout5	
187	BB	29	Read_vout5[15:8]	
188	BC	28	Read_vout5[7:0]	
189	BD	27	Status_mfr4	
190	BE	26	Status_vout4	
191	BF	25	Read_vout4[15:8]	
192	C0	24	Read_vout4[7:0]	
193	C1	23	Reserved	
194	C2	22	Status_temp	
195	C3	21	Read_temperature_1[15:8]	
196	C4	20	Read_temperature_1[7:0]	
197	C5	19	Status_mfr3	
198	C6	18	Status_vout3	
199	C7	17	Read_vout3[15:8]	
200	C8	16	Read_vout3[7:0]	
201	C9	15	Status_mfr2	
202	CA	14	Status_vout2	
203	CB	13	Read_vout2[15:8]	
204	CC	12	Read_vout2[7:0]	
205	CD	11	Reserved	
206	CE	10	Status_vin	
207	CF	9	Read_vin[15:8]	
208	D0	8	Read_vin[7:0]	
209	D1	7	Status_mfr1	
210	D2	6	Status_vout1	
211	D3	5	Read_vout1[15:8]	

## PMBus COMMAND DESCRIPTION

BYTE NUMBER DECIMAL	BYTE NUMBER HEX	LOOP BYTE NUMBER DECIMAL	DATA LOOP 4	40 BYTES PER LOOP
212	D4	4	Read_vout1[7:0]	
213	D5	3	Status_mfr0	
214	D6	2	Status_vout0	
215	D7	1	Read_vout0[15:8]	
216	D8	0	Read_vout0[7:0]	

BYTE NUMBER DECIMAL	BYTE NUMBER HEX	LOOP BYTE NUMBER DECIMAL	DATA LOOP 5	40 BYTES PER LOOP
217	D9	39	Status_mfr7	
218	DA	38	Status_vout7	
219	DB	37	Read_vout7[15:8]	
220	DC	36	Read_vout7[7:0]	
221	DD	35	Status_mfr6	
222	DE	34	Status_vout6	
223	DF	33	Read_vout6[15:8]	
224	E0	32	Read_vout6[7:0]	
225	E1	31	Status_mfr5	
226	E2	30	Status_vout5	
227	E3	29	Read_vout5[15:8]	
228	E4	28	Read_vout5[7:0]	
229	E5	27	Status_mfr4	
230	E6	26	Status_vout4	
231	E7	25	Read_vout4[15:8]	
232	E8	24	Read_vout4[7:0]	
233	E9	23	Reserved	
234	EA	22	Status_temp	
235	EB	21	Read_temperature_1[15:8]	
236	EC	20	Read_temperature_1[7:0]	
237	ED	19	Status_mfr3	Last Valid Fault Log Byte

RESERVED BYTES				
238	EE		0x00	Bytes EE - FE Return 0x00 But Must Be Read
239	EF		0x00	
240	F0		0x00	
241	F1		0x00	
242	F2		0x00	
243	F3		0x00	
244	F4		0x00	
245	F5		0x00	
246	F6		0x00	
247	F7		0x00	
248	F8		0x00	
249	F9		0x00	
250	FA		0x00	
251	FB		0x00	
252	FC		0x00	
253	FD		0x00	
254	FE		0x00	
				Use One Block Read Command to Read 255 Bytes Total, from 0x00 to 0xFE

## APPLICATIONS INFORMATION

### OVERVIEW

The LTC2978A is a power management IC that is capable of sequencing, margining, trimming, supervising output voltage for OV/UV conditions, providing fault management, and voltage read back for eight DC/DC converters. Input voltage and LTC2978A junction temperature read back are also available. Odd numbered channels can be configured to read back sense resistor voltages to provide current measurements for those channels. Analog Devices Power System Managers can coordinate operation among multiple devices using common SHARE\_CLK, FAULTB and CONTROL pins. The LTC2978A utilizes a PMBus compliant interface and command set.

### POWERING THE LTC2978A

The LTC2978A can be powered two ways. The first method requires that a voltage between 4.5V and 15V be applied to the  $V_{PWR}$  pin. See Figure 14. An internal linear regulator converts  $V_{PWR}$  down to 3.3V which drives all of the internal circuitry of the LTC2978A.

Alternatively, power from an external 3.3V supply may be applied directly to the  $V_{DD33}$  pins 16 and 17 using a voltage between 3.13V and 3.47V. Tie  $V_{PWR}$  to  $V_{DD33}$  pins. See Figure 15. All functionality is available when using this alternate power method. The higher voltages needed

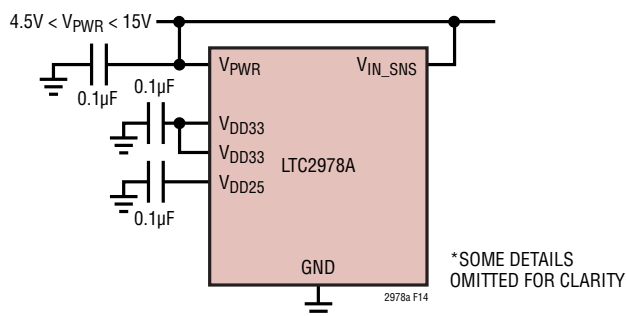

Figure 14. Powering LTC2978A Directly from an Intermediate Bus

for the  $V_{OUT\_EN[3:0]}$  pins and bias for the  $V_{SENSE}$  pins are charge-pumped from  $V_{DD33}$ .

### SETTING COMMAND REGISTER VALUES

The command register settings described herein are intended as a reference and for the purpose of understanding the registers in a software development environment. In actual practice, the LTC2978A can be completely configured for standalone operation with the ADI USB to I<sup>2</sup>C/SMBus/PMBus controller (DC1613) and software GUI using intuitive menu driven objects.

### SEQUENCE, SERVO, MARGIN AND RESTART OPERATIONS

#### Command Units On or Off

Three control parameters determine how a particular channel is turned on and off. The CONTROL pins, the OPERATION command and the value of the input voltage measured at the  $V_{IN\_SNS}$  pin ( $V_{IN}$ ). In all cases,  $V_{IN}$  must exceed  $V_{IN\_ON}$  in order to enable the device to respond to the CONTROL pin or OPERATION command. When  $V_{IN}$  drops below  $V_{IN\_OFF}$  an immediate OFF of all channels will result. Refer to the OPERATION section in the data sheet for a detailed description of the ON\_OFF\_CONFIG command.

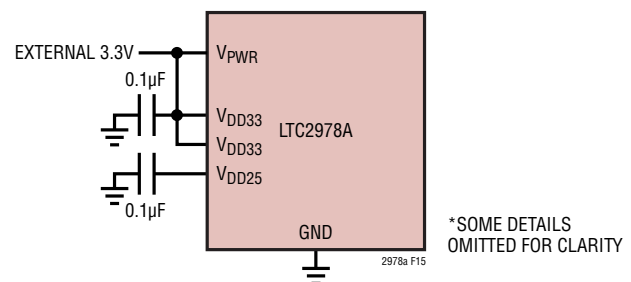

Figure 15. Powering LTC2978A from External 3.3V Supply



## APPLICATIONS INFORMATION

Some examples of typical ON/OFF configurations are:

1. A DC/DC converter may be configured to turn on anytime  $V_{IN}$  exceeds  $V_{IN\_ON}$ .
2. A DC/DC converter may be configured to turn on only when it receives an OPERATION command.
3. A DC/DC converter may be configured to turn on only via the CONTROL pin.
4. A DC/DC converter may be configured to turn on only when it receives an OPERATION command and the CONTROL pin is asserted.

### On Sequencing

The  $TON\_DELAY$  command sets the amount of time that a channel will wait following the start of an ON sequence before its  $V_{OUT\_EN}$  pin will enable a DC/DC converter. Once the DC/DC converter has been enabled, the  $TON\_RISE$  value determines the time at which the device soft-connects the DAC and servos the DC/DC converter output to the  $V_{OUT\_COMMAND}$  value. The  $TON\_MAX\_FAULT\_LIMIT$  value determines the time at which the device checks for an undervoltage condition. If a  $TON\_MAX\_FAULT$  occurs, the channel can be configured to disable the DC/DC converter and propagate the fault to other channels using the bidirectional FAULTB pins. Note that overvoltage faults are checked against the  $V_{OUT\_OV\_FAULT\_LIMIT}$  at all times the device is powered up and not in a reset state nor margining while ignoring OVs. Figure 16 shows a typical on-sequence using the CONTROL pin.

### On State Operation

Once a channel has reached the ON state, the OPERATION command can be used to command the DC/DC converter's output to margin high, margin low, or return to a nominal output voltage indicated by  $V_{OUT\_COMMAND}$ . The user also has the option of configuring a channel to continuously trim the output of the DC/DC converter to the  $V_{OUT\_COMMAND}$  voltage, or the channel's  $V_{DACPn}$  output can be placed in a high impedance state thus allowing the DC/DC converter output voltage to go to its nominal value,  $V_{DCn(NOM)}$ . Refer to the  $MFR\_CONFIG\_LTC2978$  command for details on how to configure the output voltage servo.

### Servo Modes

The ADC, DAC and internal processor comprise a digital servo loop that can be configured to operate in several useful modes. The servo target refers to the desired output voltage.

Continuous/noncontinuous trim mode.  $MFR\_CONFIG\_LTC2978A$  b[7]. In continuous trim mode, the servo will update the DAC in a closed loop fashion each time it takes a  $V_{OUT}$  reading. The update rate is determined by the time it takes to step through the ADC MUX, which is no more than  $t_{UPDATE\_ADC}$ . See Electrical Characteristics Table Note 4. In noncontinuous trim mode, the servo will drive the DAC until the ADC measures the output voltage desired and then stop updating the DAC.

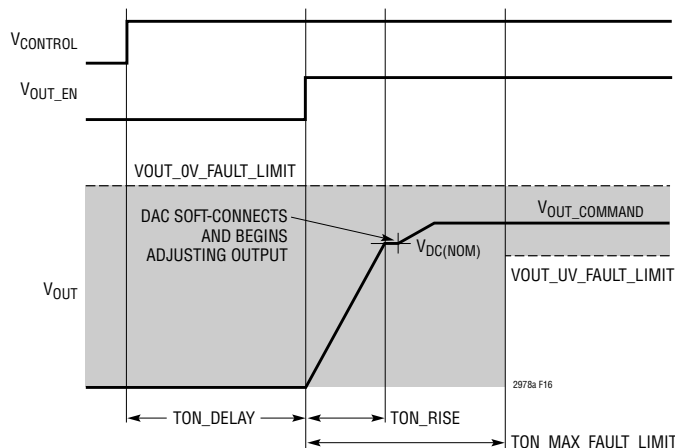

Figure 16. Typical On Sequence Using Control Pin



## APPLICATIONS INFORMATION

As part of continuous/noncontinuous trim mode, fast servo mode can be used to speed up large output transitions, such as margin commands, or ON events. To use, set `Mfr_config_fast_servo_off=0`. When enabled, fast servo is started by a change to the target voltage or a new soft-connect. The DAC is ramped one lsb every  $t_{S\_VDACP}$  period until it is near the new target voltage, at which point slow servo mode is entered to avoid overshoot.

Noncontinuous servo on warn mode. `MFR_CONFIG_LTC2978A` `b[7] = 0`, `b[6] = 1`. When in noncontinuous mode, the LTC2978A will retrim (reservo) the output if the output drifts beyond the OV or UV warn limits.

### DAC Modes

The DACs that drive the  $V_{DACn}$  pins can operate in several useful modes. See `MFR_CONFIG_LTC2978`.

- Soft-connect. Using the ADI patented soft-connect feature, the DAC output is driven to within 1 LSB of the voltage at the DC/DC's feedback node before connecting to avoid introducing transients on the output. This mode is used when servoing the output voltage. During start-up, the LTC2978A waits until `TON_RISE` has expired before connecting the DAC. This is the most common operating mode.
- Disconnected. DAC output is high Z.
- DAC manual with soft-connect. Non servo mode. The DAC soft-connects to the feedback node. Soft-connect drives the DAC code to match the voltage at the feedback node. After connection, the DAC is moved by writing DAC codes to the `MFR_DAC` register.
- DAC manual with hard-connect. Non servo mode. The DAC hard-connects to the feedback node using the current value in `MFR_DAC`. After connection, the DAC is moved by writing DAC codes to the `MFR_DAC` register.

### Margining

The LTC2978A margins and trims the output of a DC/DC converter by forcing a voltage across an external resistor connected between the DAC output and the feedback node or the trim pin. Preset limits for margining are stored in the `VOUT_MARGIN_HIGH/LOW` registers. Margining is actuated by writing the appropriate bits to the `OPERATION` register.

Margining requires the DAC to be connected. Margin requests from a non-global `OPERATION` command that occur when the DAC is disconnected will force the DAC to soft-connect. If a global (`PAGE=0xFF`) `OPERATION` command is used to margin, the DACs must already be connected using `MFR_CONFIG_LTC2978` commands. When in the margin high/low state, the DAC cannot be disconnected. The DAC can only be disconnected from the ON state.

### Off Sequencing

An off sequence is initiated using the `CONTROL` pin or the `OPERATION` command. The `TOFF_DELAY` value determines the amount of time that elapses from the beginning of the off sequence until each channel's  $V_{OUT\_EN}$  pin is pulled low, thus disabling its DC/DC converter.

### $V_{OUT}$ Off Threshold Voltage

The `MFR_VOUT_DISCHARGE_THRESHOLD` command register allows the user to specify the OFF threshold that the output voltage must decay below before the channel can enter/re-enter the ON state. The OFF threshold voltage is specified by multiplying `MFR_VOUT_DISCHARGE_THRESHOLD` and `VOUT_COMMAND`. In the event that an output voltage has not decayed below its OFF threshold before attempting to enter the ON state, the channel will

## APPLICATIONS INFORMATION

continue to be held off, the appropriate bit is set in the STATUS\_MFR\_SPECIFIC register, and the ALERTB pin will be asserted low. When the output voltage has decayed below its OFF threshold, the channel can enter the ON state.

### Automatic Restart Via MFR\_RESTART\_DELAY Command and CONTROLn pin

An automatic restart sequence can be initiated by driving the CONTROL pin to the off state for  $>10\mu\text{s}$  then releasing it. The automatic restart disables all  $V_{\text{OUT\_EN}}$  pins that are mapped to a particular CONTROL pin for a time period = MFR\_RESTART\_DELAY and then starts all DC-DC Converters according to their respective TON\_DELAYS. (See Figure 17).  $V_{\text{OUT\_EN}n}$  pins are mapped to one of the CONTROL pins by the MFR\_CONFIG\_LTC2978 command. This feature allows a host that is about to reset to restart the power in a controlled manner after it has recovered.

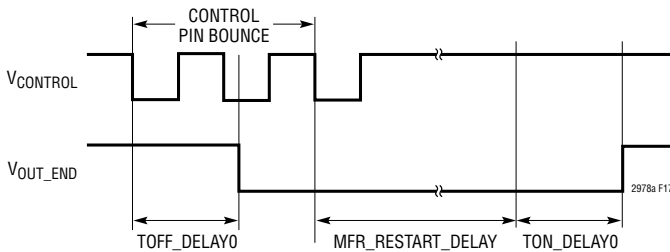

Figure 17. Off Sequence with Automatic Restart

## FAULT MANAGEMENT

### Output Overvoltage and Undervoltage Faults

The high speed voltage supervisor OV and UV fault thresholds are configured using the VOUT\_OV\_FAULT\_LIMIT and VOUT\_UV\_FAULT\_LIMIT commands, respectively. The VOUT\_OV\_FAULT\_RESPONSE and VOUT\_UV\_FAULT\_RESPONSE commands determine the

responses to OV/UV faults. Fault responses can range from disabling the DC/DC converter immediately, waiting to see if the fault condition persists for some interval before disabling the DC/DC converter, or allowing the DC/DC converter to continue operating in spite of the fault. If a DC/DC converter is disabled, the LTC2978A can be configured to retry or latch-off. The retry interval is specified using the MFR\_RETRY\_DELAY command. Latched faults are reset by toggling the CONTROL pin, using the OPERATION command, or removing and reapplying the bias voltage to the  $V_{\text{IN\_SNS}}$  pin. All fault and warning conditions result in the ALERTB pin being asserted low and the corresponding bits being set in the status registers. The CLEAR\_FAULTS command resets the contents of the status registers and deasserts the ALERTB output.

### Output Overvoltage and Undervoltage Warnings

OV and UV warning threshold voltages are processed by the LTC2978A's ADC. These thresholds are set by the VOUT\_OV\_WARN\_LIMIT and VOUT\_UV\_WARN\_LIMIT commands respectively. If a warning occurs, the corresponding bits are set in the status registers and the ALERTB output is asserted low. Note that a warning will never cause a  $V_{\text{OUT\_EN}}$  output pin to disable a DC/DC converter.

### Configuring the $V_{\text{IN\_EN}}$ Output

The  $V_{\text{IN\_EN}}$  output may be used to disable the intermediate bus voltage in the event of an output OV or UV fault. Use the MFR\_VINEN\_OV\_FAULT\_RESPONSE and MFR\_VINEN\_UV\_FAULT\_RESPONSE registers to configure the  $V_{\text{IN\_EN}}$  pin to assert low in response to VOUT\_OV/UV fault conditions. The  $V_{\text{IN\_EN}}$  output will stop pulling low when the LTC2978A is commanded to re-enter the ON state following a faulted-off condition.



APPLICATIONS INFORMATION

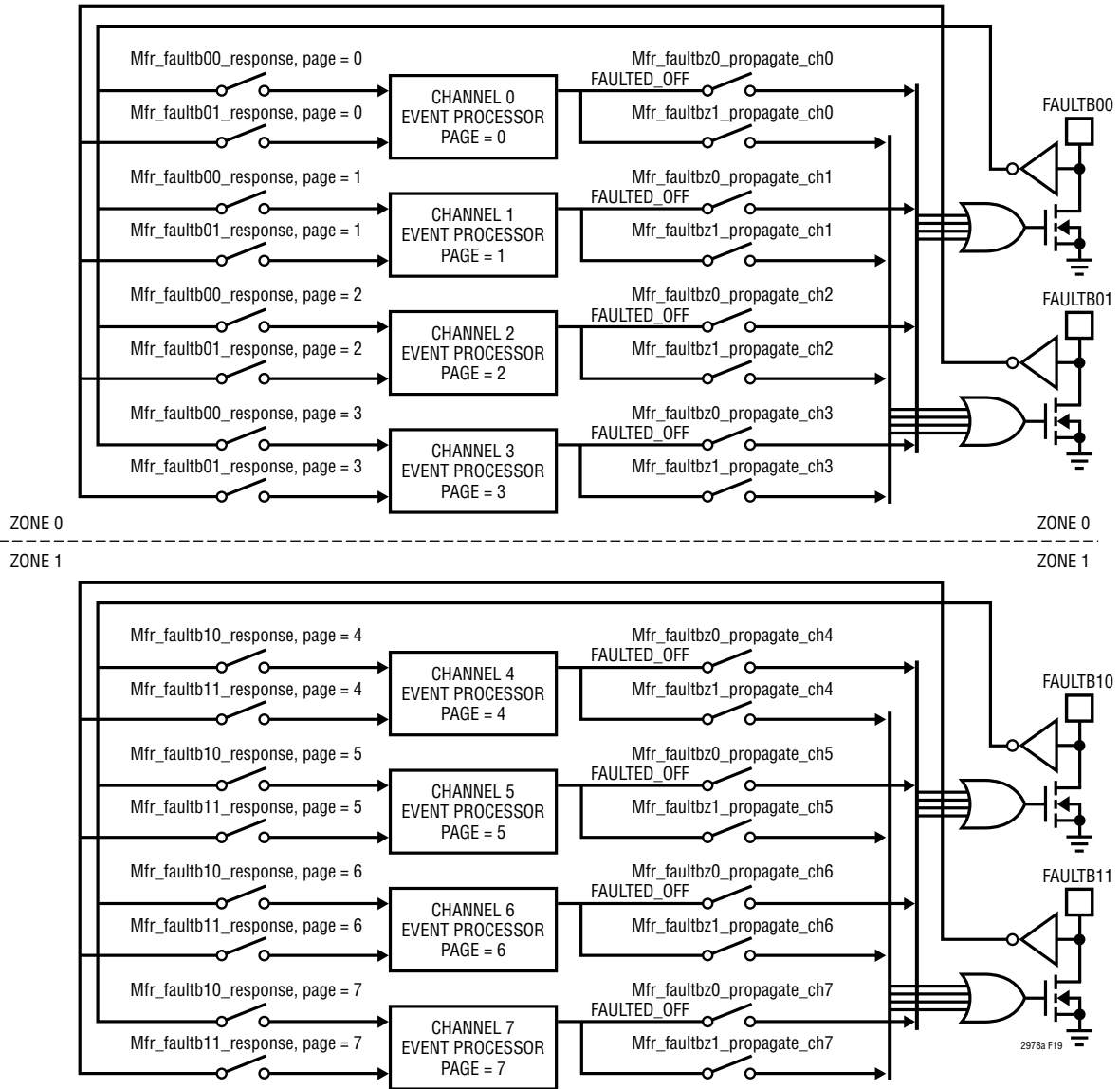

Figure 19. Channel Fault Management Block Diagram

## APPLICATIONS INFORMATION

- A FAULTBzn pin can also be asserted low by an external driver in order to initiate an immediate off-sequence after a 10µs deglitch delay.

### INTERCONNECT BETWEEN MULTIPLE LTC2978A'S

Figure 20 shows how to interconnect the pins in a typical multi-LTC2978A array.

- All VIN\_SNS lines should be tied together in a star type connection at the point where VIN is to be sensed. This will minimize timing errors for the case where the ON\_OFF\_CONFIG is configured to start the LTC2978A based on VIN and ignore the CONTROL line and the OPERATION command. In multi-part applications that are sensitive to timing differences, it is recommended that the Vin\_share\_enable bit of the MFR\_CONFIG\_ALL\_LTC2978 register be set high in order to allow SHARE\_CLK to synchronize on/off sequencing in response to the VIN\_ON and VIN\_OFF thresholds.

- Connecting all VIN\_EN lines together will allow selected faults on any DC/DC converter's output in the array to shut off a common input switch.
- ALERTB is typically one line in an array of PMBus converters. The LTC2978A allows a rich combination of faults and warnings to be propagated to the ALERTB pin.
- WDI/RESETB can be used to put the LTC2978A in the power-on reset state. Pull WDI/RESETB low for at least tRESETB to enter this state.
- The FAULTBzn lines can be connected together to create fault dependencies. Figure 20 shows a configuration where a fault on any FAULTBzn will pull all others low. This is useful for arrays where it is desired to abort a start-up sequence in the event any channel does not come up (see Figure 21).

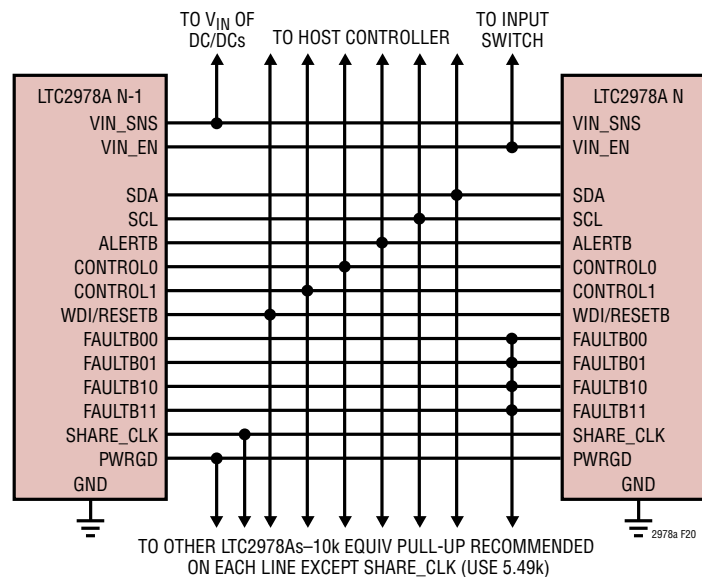

Figure 20. Typical Connections Between Multiple LTC2978As

## APPLICATIONS INFORMATION

- PWRGD reflects the status of the outputs that are mapped to it by the MFR\_PWRGD\_EN command. Figure 20 shows all the PWRGD pins connected together, but any combination may be used. Note that the latency of the PWRGD pin response may be in the range of 30ms to 185ms depending on ADC MUX settings. See Electrical Characteristics Table Note 4.

A fast deassertion of PWRGD may be implemented by wire ANDing the  $V_{IN\_EN}$  pin with the PWRGD pin. If, for example, a UV or OV fault threshold is crossed,  $V_{IN\_EN}$  will pull low if the associated bit in the MFR\_VINEN\_UV\_FAULT\_RESPONSE or MFR\_VINEN\_OV\_FAULT\_RESPONSE register is set. See Figure 22.

## APPLICATION CIRCUITS

### Trimming and Margining DC/DC Converters with External Feedback Resistors

Figure 23 shows a typical application circuit for trimming/margining a power supply with an external feedback network. The  $V_{SENSEP0}$  and  $V_{SENSEM0}$  differential inputs sense the load voltage directly, and a correction voltage is developed between the  $V_{DACP0}$  and  $V_{DACM0}$  pins by the closed-loop servo algorithm.  $V_{DACM0}$  is Kelvin connected to the point-of-load GND in order to minimize the effects of load induced grounding errors. The  $V_{DACP0}$  output is connected to the DC/DC converter's feedback node through resistor R30. For this configuration, set Mfr\_config\_dac\_pol to 0.

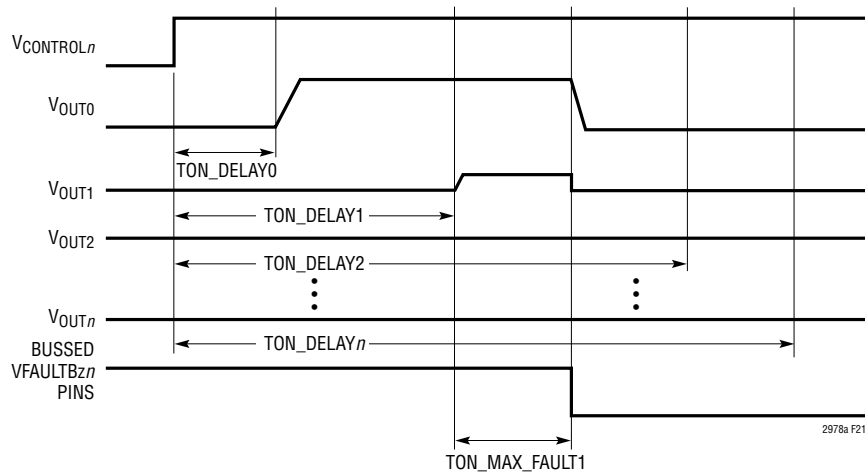

Figure 21. Aborted On Sequence Due to Channel 1 Short

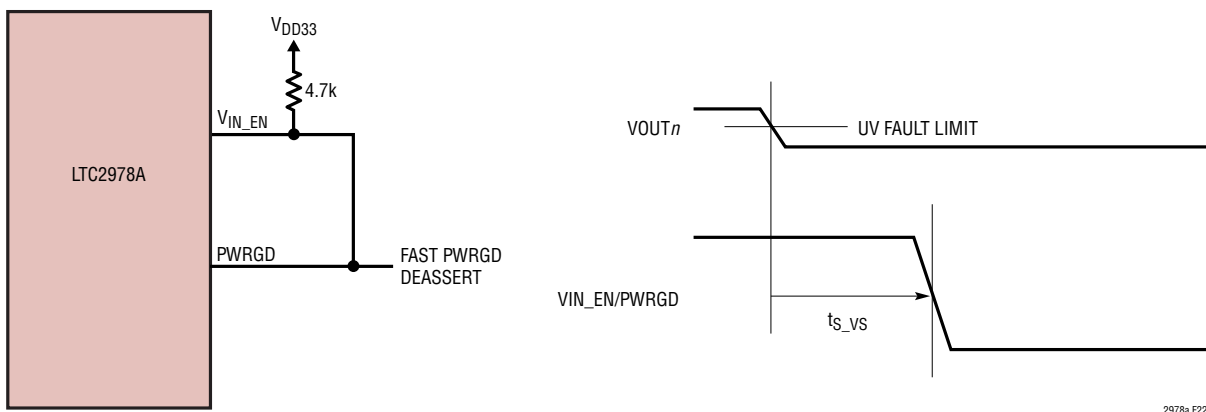

Figure 22. PWRGD Deassert

## APPLICATIONS INFORMATION

### Four-Step Resistor Selection Procedure for DC/DC Converters with External Feedback Resistors

The following four-step procedure should be used to calculate the resistor values required for the application circuit shown in Figure 23.

1. Assume values for feedback resistor R20 and the nominal DC/DC converter output voltage  $V_{DC(NOM)}$ , and solve for R10.

$V_{DC(NOM)}$  is the output voltage of the DC/DC converter when the LTC2978A's  $V_{DACP0}$  pin is in a high impedance state. R10 is a function of R20,  $V_{DC(NOM)}$ , the voltage at the feedback node ( $V_{FB}$ ) when the loop is in regulation, and the feedback node's input current ( $I_{FB}$ ).

$$R10 = \frac{R20 \cdot V_{FB}}{V_{DC(NOM)} - I_{FB} \cdot R20 - V_{FB}} \quad (1)$$

2. Solve for the value of R30 that yields the maximum required DC/DC converter output voltage  $V_{DC(MAX)}$ .

When  $V_{DACP0}$  is at 0V, the output of the DC/DC converter is at its maximum voltage.

$$R30 \leq \frac{R20 \cdot V_{FB}}{V_{DC(MAX)} - V_{DC(NOM)}} \quad (2)$$

3. Solve for the minimum value of  $V_{DACP0}$  that is needed to yield the minimum required DC/DC converter output voltage  $V_{DC(MIN)}$ .

The DAC has two full-scale settings, 1.38V and 2.65V. In order to select the appropriate full-scale setting, calculate the minimum required  $V_{DACP0(F/S)}$  output voltage:

$$V_{DACP0(F/S)} > (V_{DC(NOM)} - V_{DC(MIN)}) \cdot \frac{R30}{R20} + V_{FB} \quad (3)$$

4. Recalculate the minimum, nominal, and maximum DC/DC converter output voltages and the resulting margining resolution.

$$V_{DC(NOM)} = V_{FB} \cdot \left(1 + \frac{R20}{R10}\right) + I_{FB} \cdot R20 \quad (4)$$

$$V_{DC(MIN)} = V_{DC(NOM)} - \frac{R20}{R30} \cdot (V_{DACP0(F/S)} - V_{FB}) \quad (5)$$

$$V_{DC(MAX)} = V_{DC(NOM)} + \frac{R20}{R30} \cdot V_{FB} \quad (6)$$

$$V_{RES} = \frac{\frac{R20}{R30} \cdot V_{DACP0(F/S)}}{1024} \text{ V/DAC LSB} \quad (7)$$

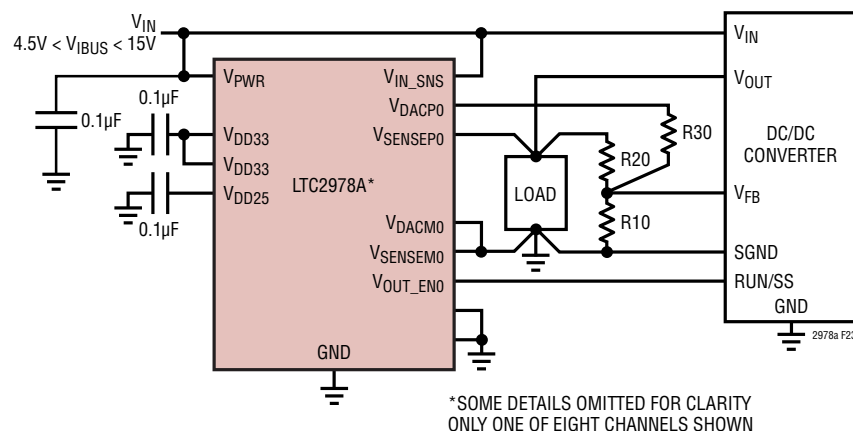

Figure 23. Application Circuit for DC/DC Converters with External Feedback Resistors







## APPLICATIONS INFORMATION

LTC2978 bit b[9] = 1 in order to enable high res mode. The  $V_{OUT\_EN}$  pin will assert low in this mode and cannot be used to control a DC/DC converter. The  $V_{DACP}$  output pin is also unavailable.

### Measuring Current with a Sense Resistor

A circuit for measuring current with a sense resistor is shown in Figure 25. The balanced filter rejects both common mode and differential mode noise from the output of the DC/DC converter. The filter is placed directly across the sense resistor in series with the DC/DC converter's inductor. Note that the current sense inputs must be limited to less than 6V with respect to ground. Select  $R_{CM}$  and  $C_{CM}$  such that the filter's corner frequency is  $< 1/10$  the DC/DC converter's switching frequency. This will result in a current sense waveform that offers a good compromise between the voltage ripple and the delay through the filter. A value  $1k\Omega$  for  $R_{CM}$  is suggested in order to minimize gain errors due to the current sense inputs' internal resistance.

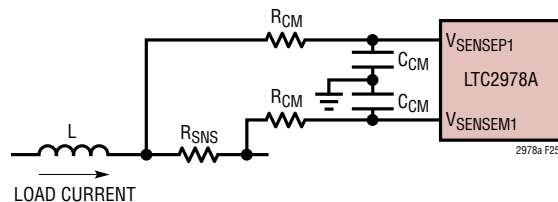

Figure 25. Sense Resistor Current Sensing Circuits

### Measuring Current with Inductor DCR

Figure 26 shows the circuit for applications that require DCR current sense. A second order RC filter is required in these applications in order to minimize the ripple voltage seen at the current sense inputs. A value of  $1k\Omega$  is suggested for  $R_{CM1}$  and  $R_{CM2}$  in order to minimize gain errors due to the current sense inputs' internal resistance.  $C_{CM1}$  should be selected to provide cancellation of the zero created by the DCR and inductance, i.e.  $C_{CM1} = L / (DCR \cdot R_{CM1})$ .  $C_{CM2}$  should be selected to provide a second stage corner frequency at  $< 1/10$  of the DC/DC converter's switching frequency. In addition,  $C_{CM2}$  needs to be much smaller than  $C_{CM1}$  in order to prevent significant loading of the filter's first stage.

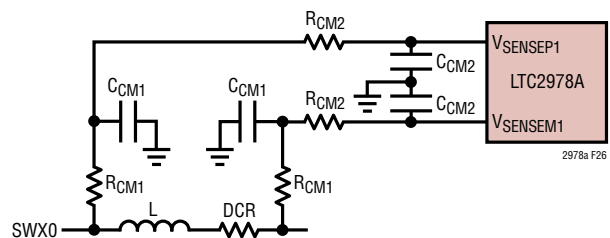

Figure 26. Inductor DCR Current Sensing Circuits

## APPLICATIONS INFORMATION

### Single Phase Design Example

As a design example for a DCR current sense application, assume  $L = 2.2\mu\text{H}$ ,  $\text{DCR} = 10\text{m}\Omega$ , and  $F_{\text{SW}} = 500\text{kHz}$ .

Let  $R_{\text{CM}1} = 1\text{k}\Omega$  and solve for  $C_{\text{CM}1}$ :

$$C_{\text{CM}1} \geq \frac{2.2\mu\text{H}}{10\text{m}\Omega \cdot 1\text{k}\Omega} = 220\text{nF}$$

Let  $R_{\text{CM}2} = 1\text{k}\Omega$ . In order to get a second pole at  $F_{\text{SW}}/10 = 50\text{kHz}$ :

$$C_{\text{CM}2} \cong \frac{1}{2\pi \cdot 50\text{kHz} \cdot 1\text{k}\Omega} = 3.18\text{nF}$$

Let  $C_{\text{CM}2} = 3.3\text{nF}$ . Note that since  $C_{\text{CM}2}$  is much less than  $C_{\text{CM}1}$  the loading effects of the second stage filter on the matched first stage are not significant. Consequently, the delay time constant through the filter for the current sense waveform will be approximately  $3\mu\text{s}$ .

### Measuring Multiphase Currents

For current sense applications with more than one phase, RC averaging may be employed. Figure 27 shows an example of this approach for a 3-phase system with DCR current sensing. The current sense waveforms are averaged together prior to being applied to the second stage of the filter consisting of  $R_{\text{CM}2}$  and  $C_{\text{CM}2}$ . Because the  $R_{\text{CM}1}$  resistors for the three phases are in parallel, the value of  $R_{\text{CM}1}$  must be multiplied by the number of phases. Also note that since the DCRs are effectively in parallel, the value for  $\text{IOUT\_CAL\_GAIN}$  will be equal to the inductor's DCR divided by the number of phases. Care should be taken in the layout of the multiphase inductors to keep the PCB trace resistance from the DC side of each inductor to the summing node balanced in order to provide the most accurate results.

### Multiphase Design Example

Using the same values for inductance and DCR from the previous design example, the value for  $R_{\text{CM}1}$  will be  $3\text{k}\Omega$  for a three phase DC/DC converter if  $C_{\text{CM}1}$  is left at  $220\text{nF}$ . Similarly, the value for  $\text{IOUT\_CAL\_GAIN}$  will be  $\text{DCR}/3 = 3.33\text{m}\Omega$ .

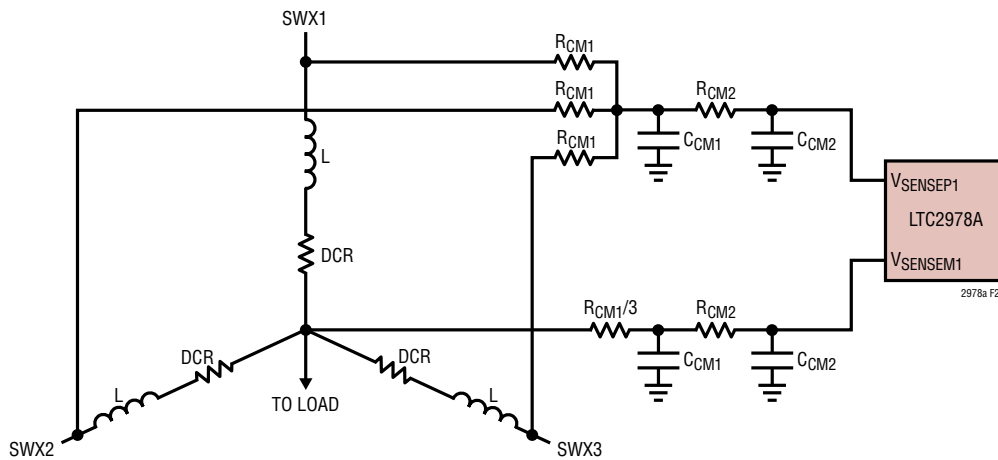

Figure 27. Multiphase DCR Current Sensing Circuits

## APPLICATIONS INFORMATION

### Anti-aliasing Filter Considerations

Noisy environments require an anti-aliasing filter on the input to the LTC2978A's ADC. The R-C circuit shown in Figure 28 is adequate for most situations. Keep  $R40 = R50 \leq 200\Omega$  to minimize ADC gain errors, and select a value for capacitors C10 and C20 that does not add too much additional response time to the OV/UV supervisor, e.g.  $\tau \cong 10\mu s$  ( $R = 100\Omega$ ,  $C = 0.1\mu F$ ).

### Sensing Negative Voltages

Figure 29 shows the LTC2978A sensing a negative power supply ( $V_{EE}$ ). The R1/R2 resistor divider translates the negative supply voltage to the LTC2978A's VSENSE1 input while the VSENSE1 input is tied to the REFP pin which

has a typical output voltage of 1.23V. The voltage divider should be configured in order to present about 0.5V to the voltage sense inputs when the negative supply reaches its POWER\_GOOD\_ON threshold so that the current flowing out of the VSENSE1 pin is minimized to  $\sim 1\mu A$ . The relationship between the POWER\_GOOD\_ON register value and the corresponding negative supply value can be expressed as:

$$V_{EE} = V_{REFP} - (\text{READ\_VOUT}) \cdot \left( \frac{R2}{R1} + 1 \right) - 1\mu A \cdot R2$$

Where READ\_VOUT returns  $V_{SENSEP} - V_{SENSEM}$

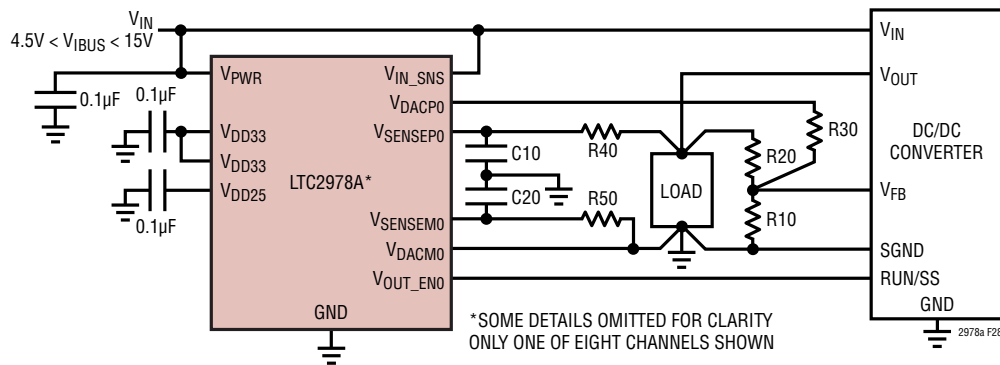

Figure 28. Antialiasing Filter on VSENSE Lines

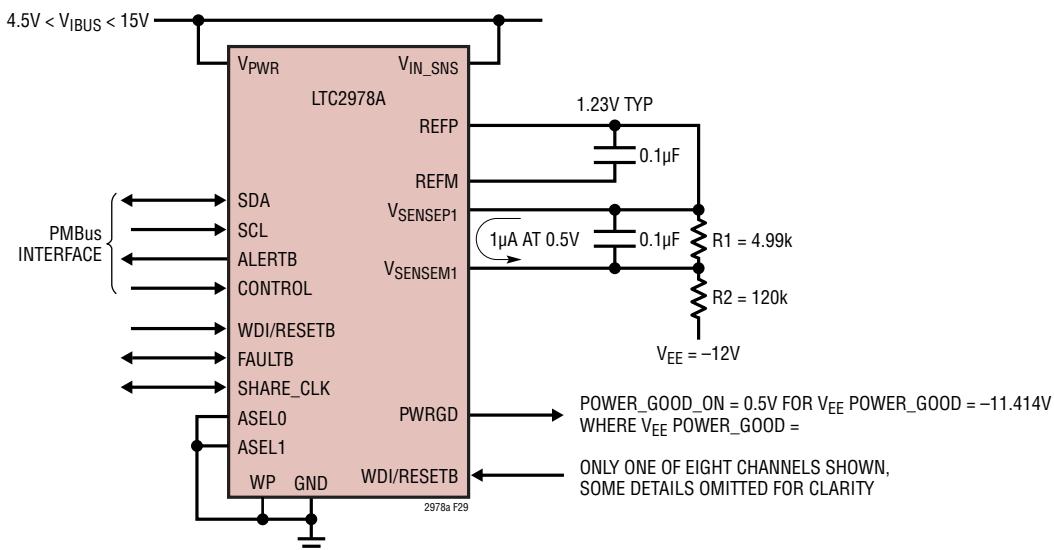

Figure 29. Sensing Negative Voltages

## APPLICATIONS INFORMATION

### Connecting the DC1613 USB to I<sup>2</sup>C/SMBus/PMBus Controller to the LTC2978A in System

The DC1613 USB to I<sup>2</sup>C/SMBus/PMBus Controller can be interfaced to LTC2978As on the user's board for programming, telemetry and system debug. The controller, when used in conjunction with LTpowerPlay software, provides a powerful way to debug an entire power system. Failures are quickly diagnosed using telemetry, fault status registers and the fault log. The final configuration can be quickly developed and stored to the LTC2978A's EEPROM.

Figures 30 and 31 illustrate application schematics for powering, programming and communicating with one or more LTC2978A's via the DC1613 I<sup>2</sup>C/SMBus/PMBus controller regardless of whether or not system power is present.

Figure 30 shows the recommended schematic to use when the LTC2978A is powered by the system intermediate bus through its V<sub>PWR</sub> pin.

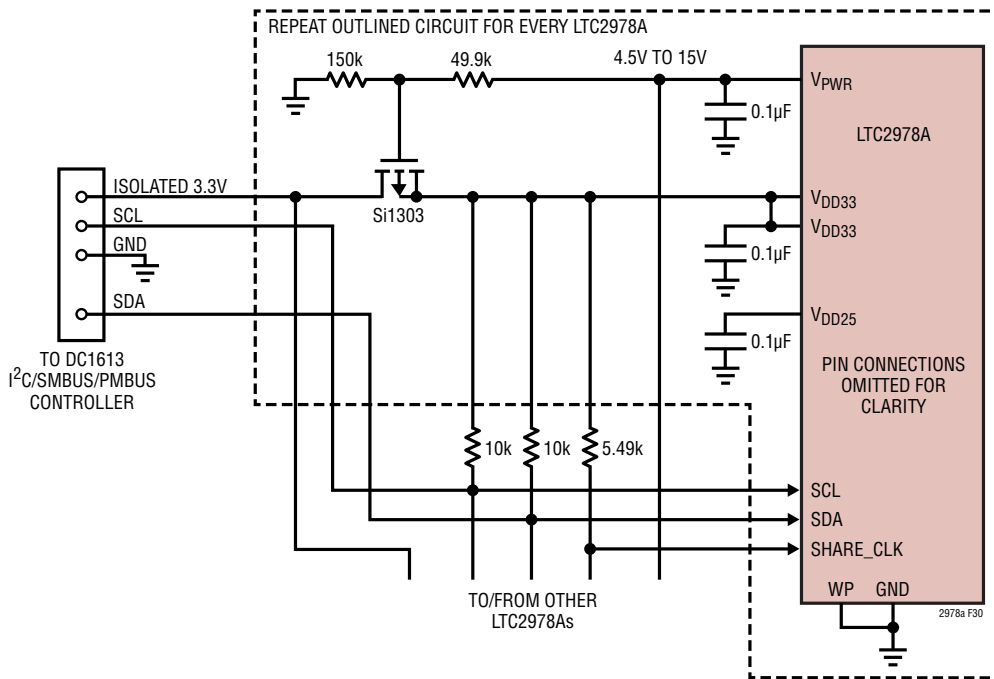

Figure 30. DC1613 Controller Connections When V<sub>PWR</sub> is Used



## APPLICATIONS INFORMATION

### LTpowerPlay: AN INTERACTIVE GUI FOR POWER SYSTEM MANAGERS

LTpowerPlay is a powerful Windows based development environment that supports Analog Devices Power System Manager ICs with EEPROM, including the LTC2978A 8-channel PMBus Power System Manager. The software supports a variety of different tasks. You can use LTpowerPlay to evaluate Analog Devices ICs by connecting to a demo board system. LTpowerPlay can also be used in an offline mode (with no hardware present) in order to build a multi-chip configuration file that can be saved and reloaded at a later time. LTpowerPlay provides unprecedented diagnostic and debug features. It becomes a valuable diagnostic

tool during board bring-up to program or tweak the power management scheme in a system or to diagnose power issues when bringing up rails. LTpowerPlay utilizes Analog Devices's DC1613 USB-to-I<sup>2</sup>C/SMBus/PMBus Controller to communicate with one of many potential targets, including the DC1540 demo board set, the DC1508 socketed programming board, or a customer target system. The software also provides an automatic update feature to keep the software current with the latest set of device drivers and documentation. A great deal of context sensitive help is available within LTpowerPlay along with several tutorial demos. Complete information is available at:

[www.linear.com/ltpowerplay](http://www.linear.com/ltpowerplay)

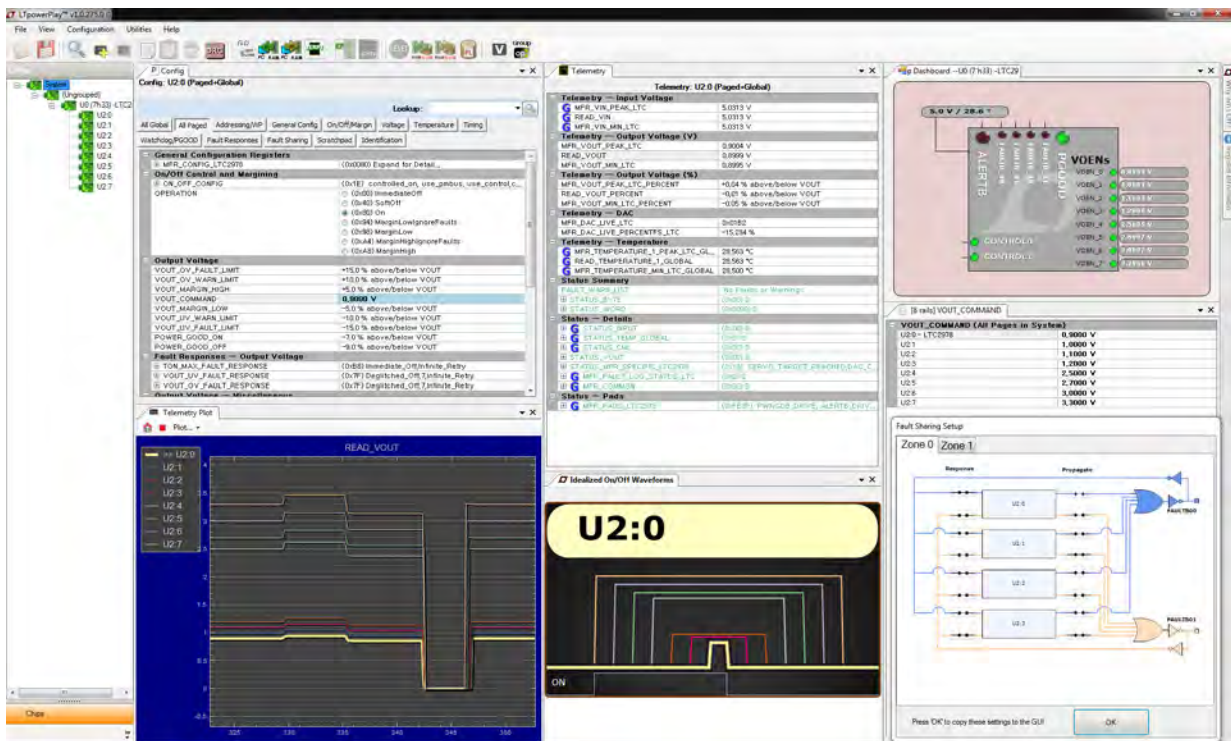

## APPLICATIONS INFORMATION

### PCB ASSEMBLY AND LAYOUT SUGGESTIONS

#### Bypass Capacitor Placement

The LTC2978A requires 0.1  $\mu\text{F}$  bypass capacitors between the  $V_{\text{DD}33}$  pins and GND, the  $V_{\text{DD}25}$  pin and GND, and the REFP pin and REFM pin. If the chip is being powered from the  $V_{\text{PWR}}$  input, then that pin should also be bypassed to GND by a 0.1  $\mu\text{F}$  capacitor. In order to be effective, these capacitors should be made of high quality ceramic dielectric such as X5R or X7R and be placed as close to the chip as possible.

#### Exposed Pad Stencil Design

The LTC2978A's package is thermally and electrically efficient. This is enabled by the exposed die attach pad on the under side of the package which must be soldered down to the PCB or mother board substrate. It is a good practice to minimize the presence of voids within the exposed pad inter-connection. Total elimination of voids is difficult, but the design of the exposed pad stencil is key. Figure 32 shows a suggested screen print pattern.

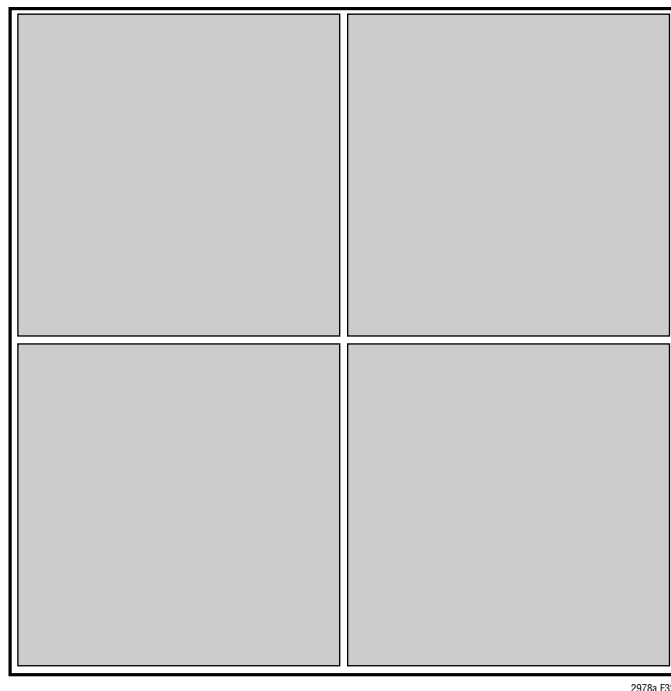

Figure 32. Suggested Screen Pattern for Die Attach Pad

The proposed stencil design enables out-gassing of the solder paste during reflow as well as regulating the finished solder thickness. See IPC7525A.

#### PC Board Layout

Mechanical stress on a PC board and soldering-induced stress can cause the LTC2978A's reference voltage and voltage drift to shift. A simple way to reduce these stress-related shifts is to mount the IC near the short edge of the PC board, or in a corner. The board edge acts as a stress boundary, or a region where the flexure of the board is minimal.

#### Unused ADC Sense Inputs

Connect all unused ADC sense inputs ( $V_{\text{SENSE}n}$  or  $V_{\text{SENSE}EMn}$ ) to GND. In a system where the inputs are connected to removable cards and may be left floating in certain situations, connect the inputs to GND using 100k resistors. Place the 100k resistors before any filter components, as shown in Figure 33, to prevent loading of the filter.

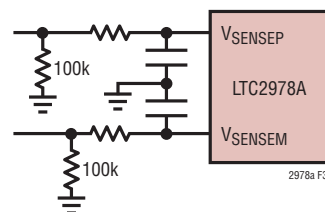

Figure 33. Connecting Unused Inputs to GND



## PACKAGE DESCRIPTION

Please refer to <http://www.linear.com/product/LTC2978A#packaging> for the most recent package drawings.

**UP Package**  
**64-Lead Plastic QFN (9mm × 9mm)**  
 (Reference LTC DWG # 05-08-1705 Rev C)

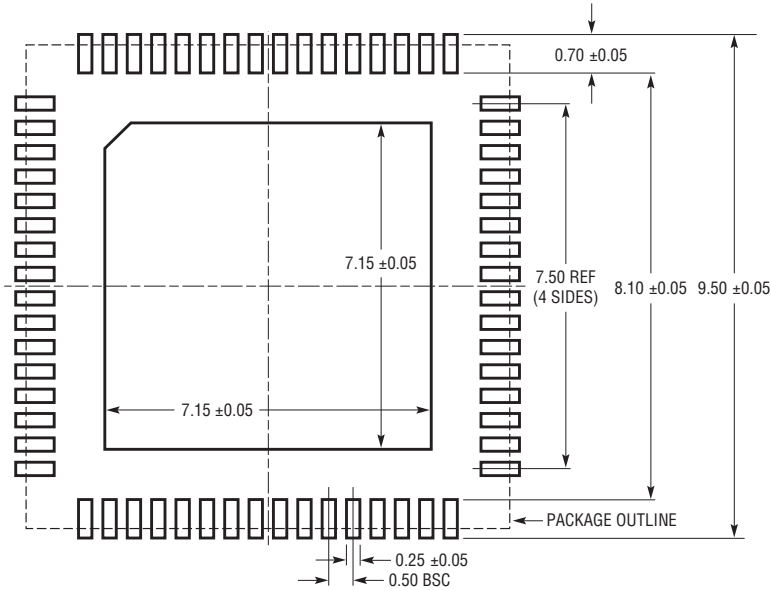

RECOMMENDED SOLDER PAD PITCH AND DIMENSIONS  
 APPLY SOLDER MASK TO AREAS THAT ARE NOT SOLDERED

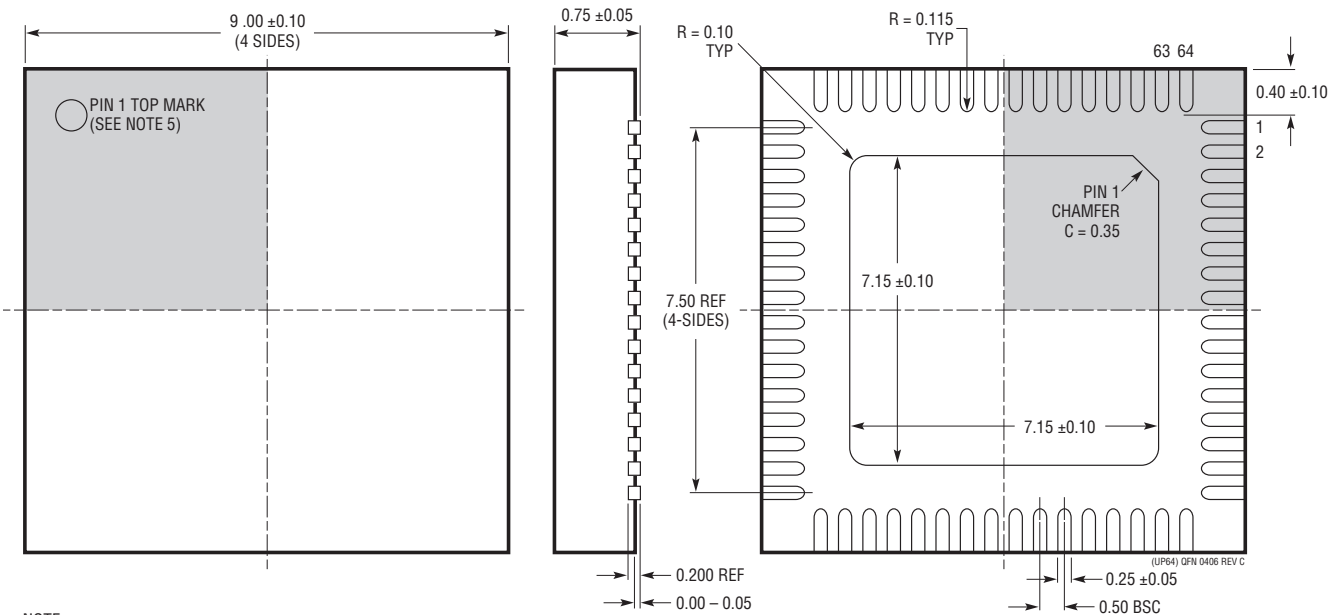

- NOTE:
1. DRAWING CONFORMS TO JEDEC PACKAGE OUTLINE MO-220 VARIATION WJNR-5
  2. ALL DIMENSIONS ARE IN MILLIMETERS
  3. DIMENSIONS OF EXPOSED PAD ON BOTTOM OF PACKAGE DO NOT INCLUDE MOLD FLASH. MOLD FLASH, IF PRESENT, SHALL NOT EXCEED 0.20mm ON ANY SIDE, IF PRESENT
  4. EXPOSED PAD SHALL BE SOLDER PLATED
  5. SHADED AREA IS ONLY A REFERENCE FOR PIN 1 LOCATION ON THE TOP AND BOTTOM OF PACKAGE
  6. DRAWING NOT TO SCALE

BOTTOM VIEW—EXPOSED PAD

(UP64) QFN 0406 REV C



## REVISION HISTORY

REV	DATE	DESCRIPTION	PAGE NUMBER
A	1/14	Improved the voltage range for ADC total unadjusted error (TUE) specification, voltage sense mode, from >1.8V to >1V	5
		Added ADC TUE specification for Current Sense Mode	5
		Consolidated previous ADC specifications—INL, DNL, voltage sense offset error, gain error—into TUE	5
		Updated $V_{OS\_CMP}$ offset voltage specification	7
		$V_{VOUT\_ENn}$ output high voltage specification: changed minimum from 11.6V To 10V	7
B	10/17	Added "Not Recommended for New Designs"	1

