

# DC MOTOR 3 click schematic v100

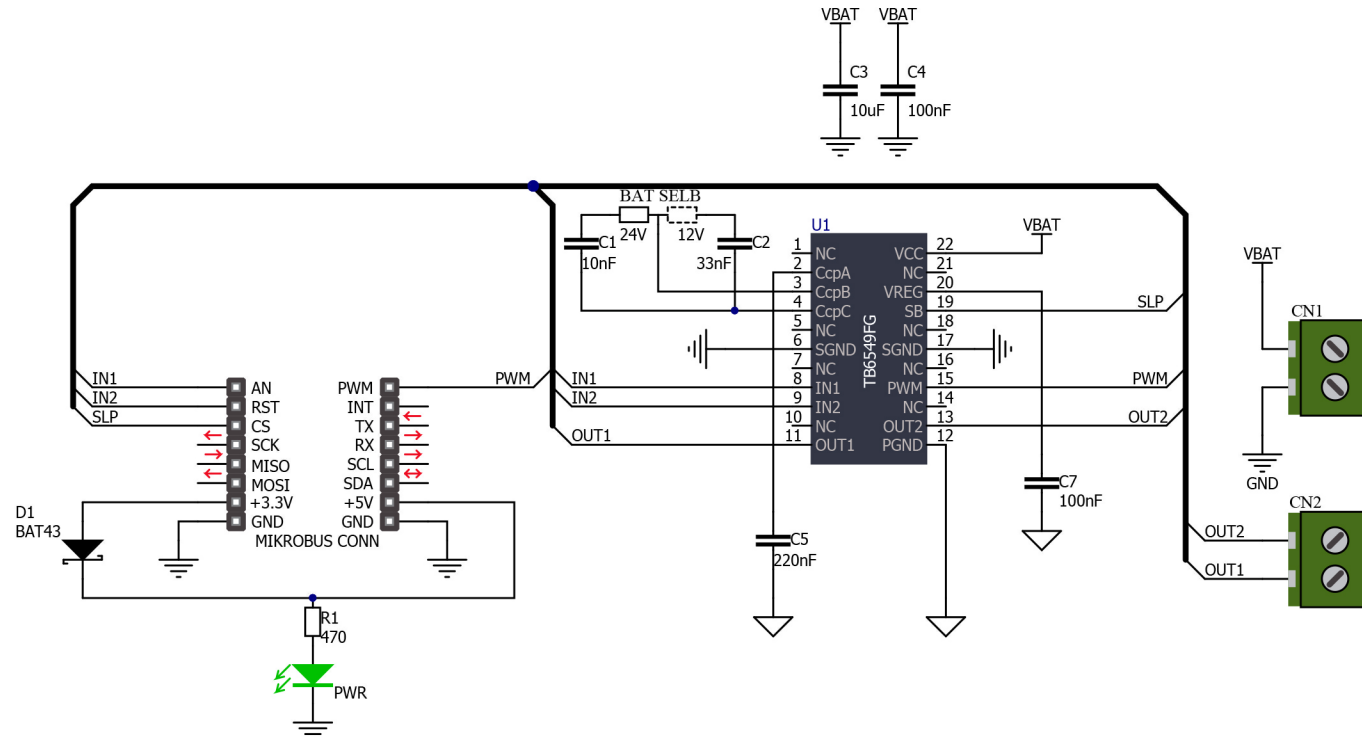

[www.mikroe.com](http://www.mikroe.com)