





Drawing No.	Rev.	Date	Page
SP0605A-3C	B	2023/04/21	1/10

# LED APPROVAL SHEET

Part No: **SP0605A-3C**

NOTE :  
**Green Part**

MAKER			CUSTOMER	
				
R&D	QA	Sales	Checked	Approved
				

Prepared	Checked	Approved
Rachel Lee	Sky Lin	Kenneth Wu

Drawing No.	Rev.	Date	Page
SP0605A-3C	B	2023/04/21	1/10

**Description of P/N No.**

**SP0605A – 3 C**



Three chip Series

SOLIDLITE LED - 0605 SMD-PCB – 0.4t

**Description of Lot.**



Month



NO.

**Description of Rank**

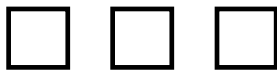

Vf Code : See the page.8/10



Iv Code : See the page.8/10



λ d Code : See the page.8/10

<b>Solidlite Corp.</b>		
P/N :	<input type="text"/>	.
Lot :	<input type="text"/>	.
Date:	<input type="text"/>	. Rank: <input type="text"/>
Q'ty :	<input type="text"/>	. QA <input type="text"/>

### Absolute Maximum Ratings at $T_A=25^\circ\text{C}$

Parameter	MAX.	Unit
DC forward current	R/G/B:30	mA
Power Dissipation	R:100 G/B:120	mW
Pulse Current (1/10 duty, 10ms Pulse width)	R/G/B:100	mA
Reverse Voltage ( $V_R$ )	5	V
Operating Temperature Range	$-40^\circ\text{C}$ to $+85^\circ\text{C}$	
Storage Temperature Range	$-55^\circ\text{C}$ to $+100^\circ\text{C}$	
Lead Soldering Temperature	$260^\circ\text{C}$ for 10 seconds	

### Electrical and Optical Characteristics at $T_A=25^\circ\text{C}$

Parameter	Test Condition	Symbol	Min.	Typ.	Max.	Unit	
Reverse Current	$V_R=5\text{V}$	$I_R$	—	—	100	$\mu\text{A}$	
Viewing Angle	$I_F=5\text{mA}$	$2\theta_{1/2}$	—	130	—	deg	
Forward Voltage	$I_F=5\text{mA}$	$V_F$	Die1 Red	1.6	—	2.1	V
			Die2 Green	2.7	—	3.2	
			Die3 Blue	2.7	—	3.1	
Dominant Wavelength	$I_F=5\text{mA}$	$\lambda_d$	Die1 Red	615	—	635	nm
			Die2 Green	515	—	535	
			Die3 Blue	460	—	480	
Luminous Intensity	$I_F=5\text{mA}$	$I_v$	Die1 Red	15	—	40	mcd
			Die2 Green	70	—	200	
			Die3 Blue	20	—	45	

Recommend forward current for longer duration is 5mA.  
 These values measured by Optical Spectrum Analyzer of SOLIDLITE.

#### Package outline dimensions :

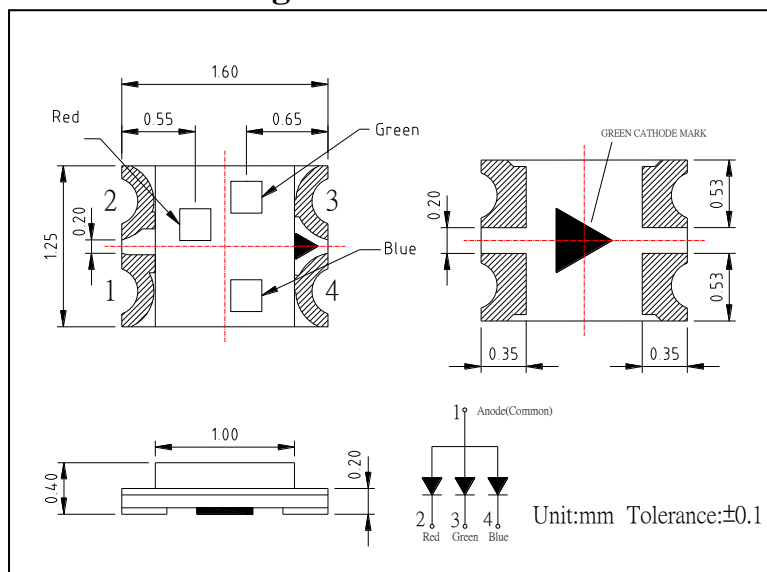

#### Recommended pad :

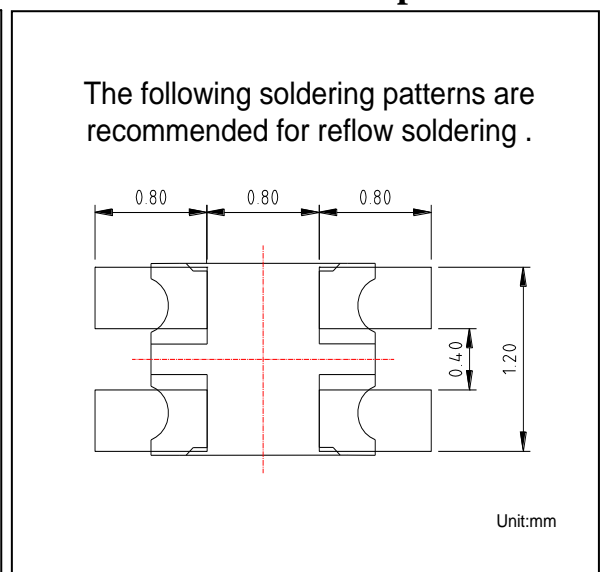

Drawing No.	Rev.	Date	Page
SP0605A-3C	B	2023/04/21	1/10

## Typical Electrical / Optical Characteristics Curves

(25°C Ambient Temperature Unless Otherwise Noted)

Luminous Intensity vs. Ambient Temperature

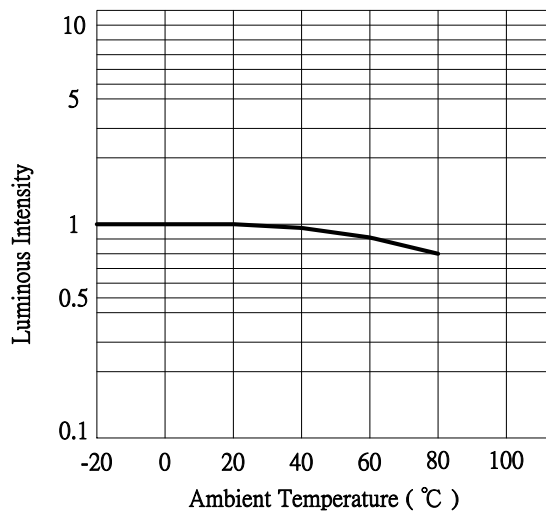

Relative Intensity vs. Forward Current

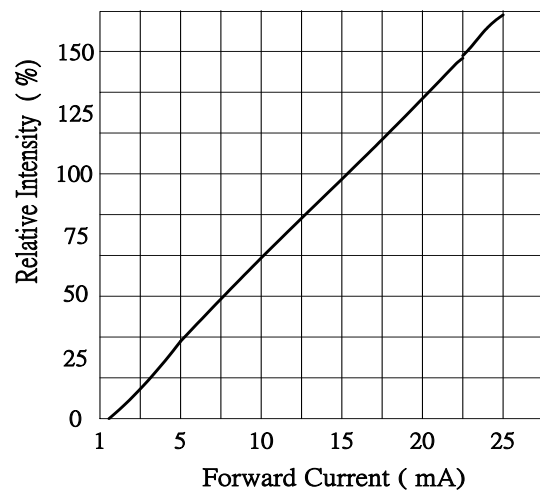

Forward Current vs. Ambient Temperature

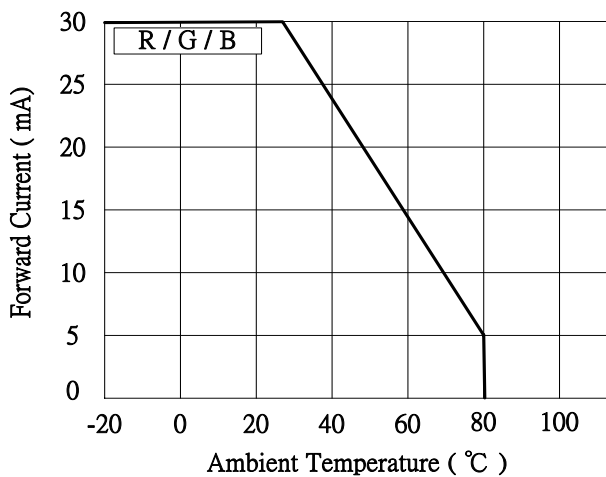

Forward Current vs. Forward Voltage

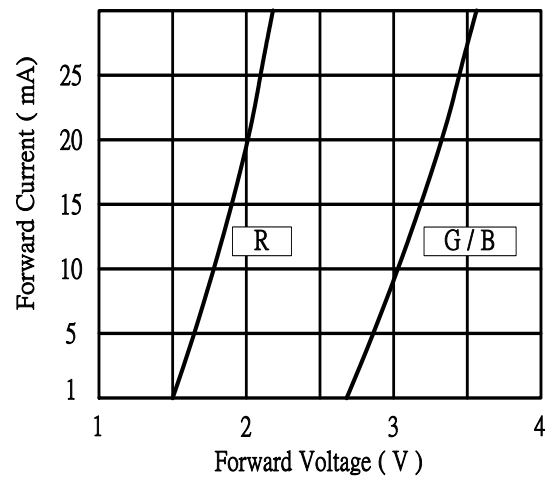

Drawing No.	Rev.	Date	Page
SP0605A-3C	B	2023/04/21	1/10

### Relative Intensity vs Wavelength

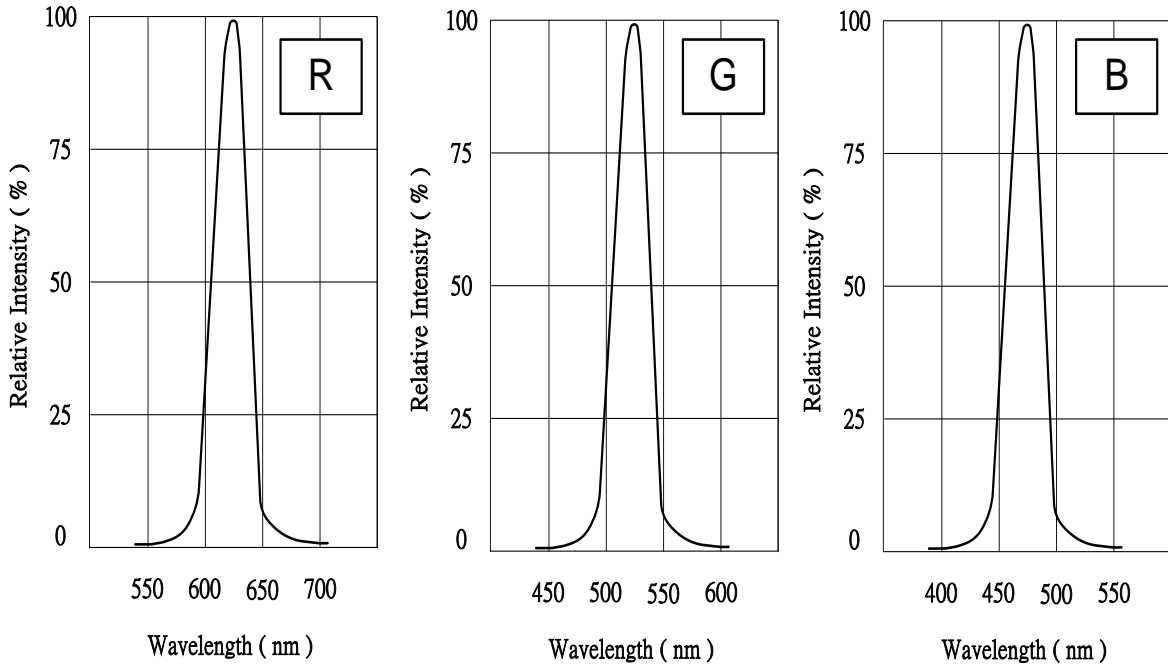

### Spatial Distribution

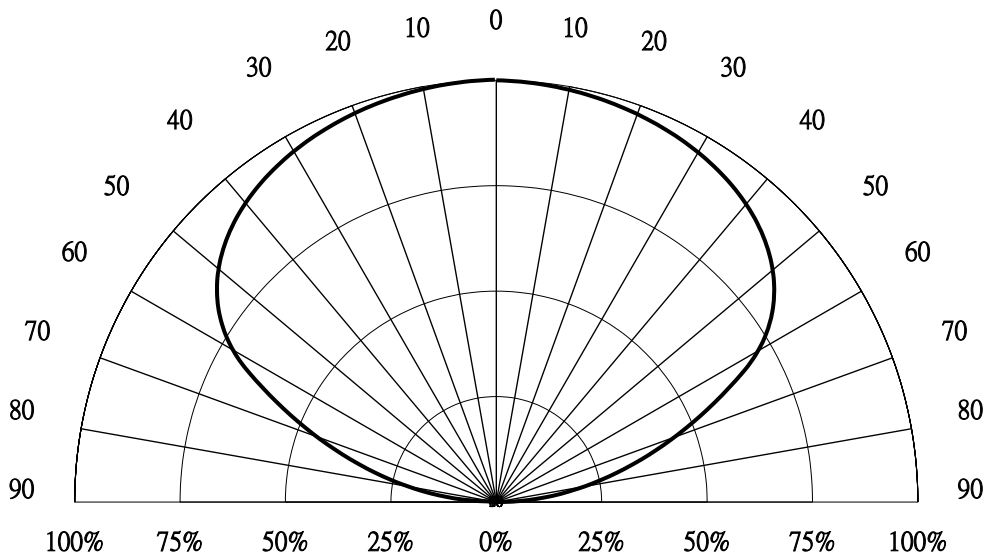

Drawing No.	Rev.	Date	Page
SP0605A-3C	B	2023/04/21	1/10

### Surface Mounting Condition

In automatic mounting of the SMD LEDs on printed circuit boards, any bending, expanding and pulling forces or shock against the SMD LEDs shall be kept min. to prevent them from electrical failures and mechanical damages of the devices.

### Soldering Reflow

Soldering of the SMD LEDs shall conform to the soldering condition in the individual specifications. SMD LEDs are designed for Reflow Soldering.

In the reflow soldering, too high temperature and too large temperature gradient such as rapid heating / cooling may cause electrical & optical failure and damages of the devices.

Solidlite can not guarantee the LED after they have been assembled using the solder dipping method.

### Recommended Soldering Temperature Time Profile (Reflow Soldering)

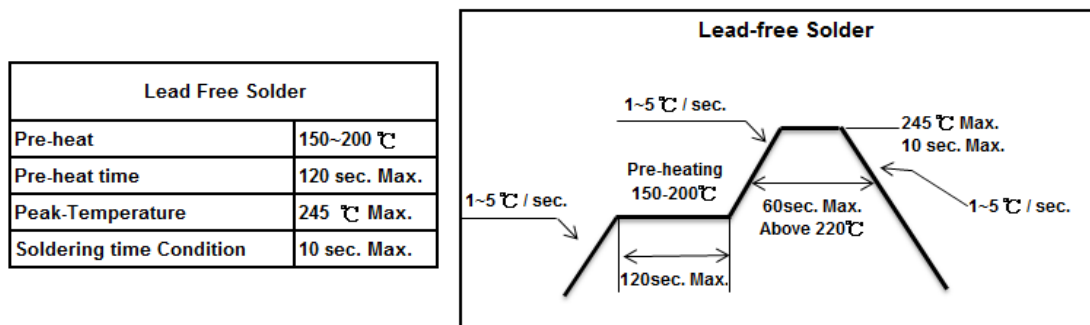

### Reliability Test Item and Conditions

• Results of Reliability Test

\*Test(Note)The values are based on 1-die performance.

No	Item	Test Condition	Test Hours/Cycles	Sample No	Ac / Re
1	DC Operating Life	R/G/B ~I <sub>F</sub> : 5mA	1,000 HRS	50 PCS	0 / 1
2	High Temperature Storage	Temp : 100°C	1,000 HRS	50 PCS	0 / 1
3	Low Temperature Storage	Temp : -55°C	1,000 HRS	50 PCS	0 / 1
4	Thermal Shock Test	-40 °C ↔ 80°C 5min 8secs 5min	100 CYCLES	50 PCS	0 / 1
5	Temperature Cycle	-40°C~25°C~100°C~25°C 30min 5min 30min 5min	300 CYCLES	50 PCS	0 / 1
6	Temp. & Humidity	T <sub>A</sub> =85°C,RH=85%	1,000 HRS	50 PCS	0 / 1

• The Reliability Criteria of SMD LED

Item	Symbol	Test Condition	Limit	
			Min.	Max.
Forward Voltage	V <sub>F</sub>	I <sub>F</sub> : 5mA	-	U.S.L*1.2
Reverse Current	I <sub>R</sub>	V <sub>R</sub> : 5V	-	U.S.L*2
Power	P <sub>O</sub>	I <sub>F</sub> : 5mA	L.S.L.*0.5	

\*U.S.L. : Upper Standard Level

\*L.S.L. : Lower Standard Level

### Package Reel & Static Shielding Bag Dimensions :

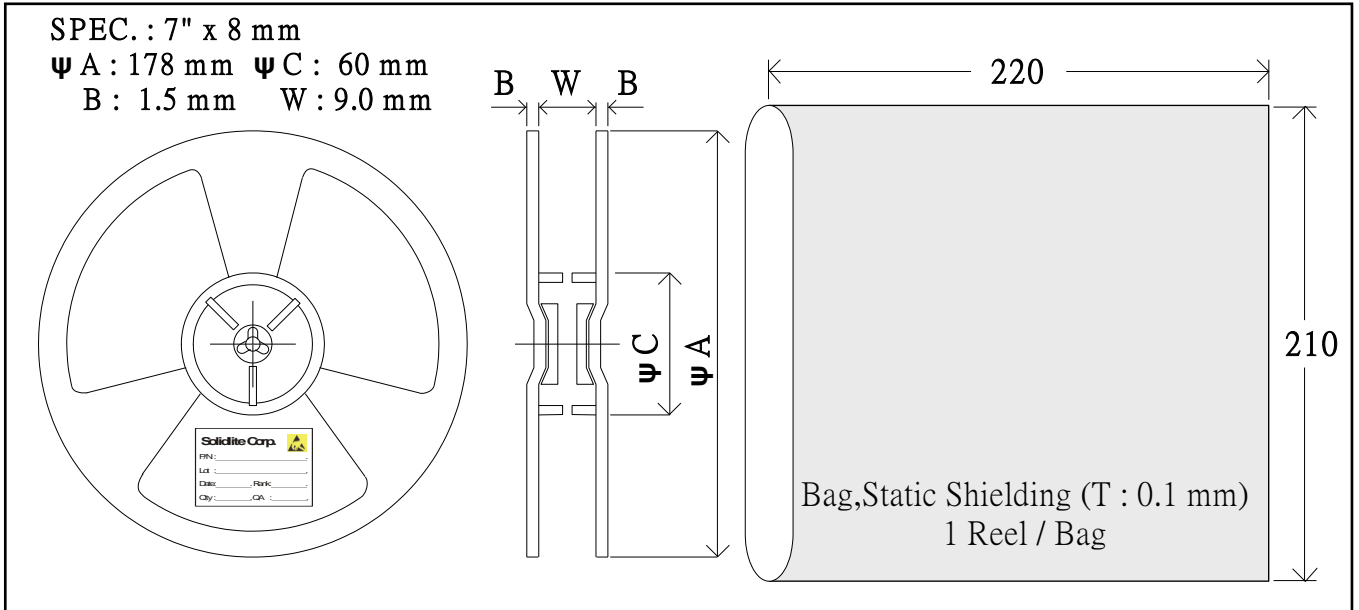

### Package Carrier Tape Dimensions : 3,000 pcs/Reel

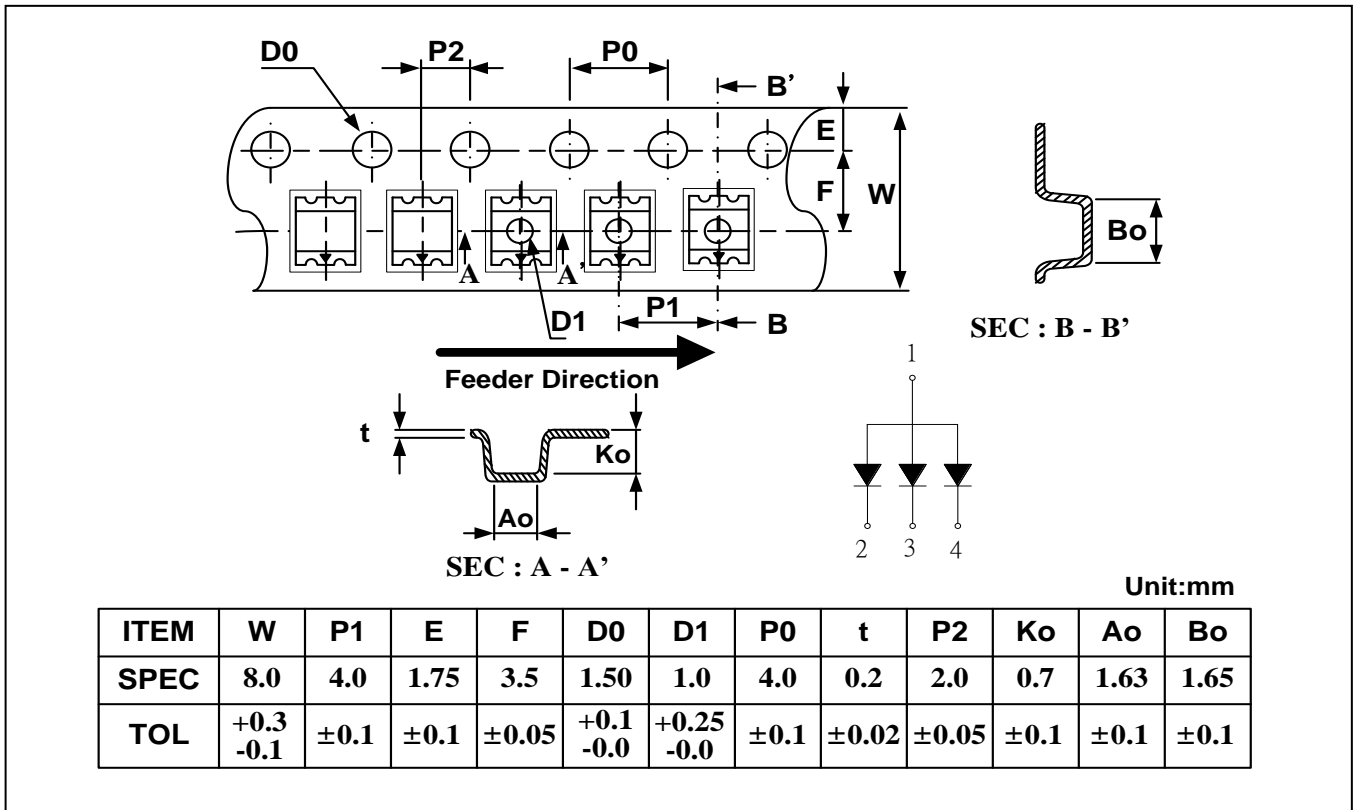

## Ranks Combination

V <sub>f</sub> V <sub>F@5mA</sub> (Voltage)	Color	Spec. Range	Rank
	Red	1.6 ~ 2.1	3
	Green	2.7 ~ 3.2	
	Blue	2.7 ~ 3.1	

Luminous Intensity I <sub>v@5mA</sub> (mcd)	Color	Spec. Range	Rank
	Red	15 ~ 40	D
	Green	70 ~ 200	
	Blue	20 ~ 45	

Dominant Wavelength λ <sub>d@5mA</sub> (nm)	Color	Spec. Range	Rank
	Red	615 ~ 635	2
	Green	515 ~ 535	
	Blue	460 ~ 480	

The quantity ratio of the ranks is decided by SOLIDLITE.

Note:

- 1.The products are sensitive to static electricity and care must be fully taken when handling products.
- 2.Measurement Uncertainty of the Luminous Intensity: ±10%
3. Measurement Uncertainty of the Dominant Wavelength: ±1nm
4. Measurement Uncertainty of the Voltage: ±0.05V

## Cautions :

### 1. Storage

#### \*Storage Conditions

Before opening the package:

The LEDs should be kept at 30°C or less and 90%RH or less. The LEDs should be used within a year. When storing the LEDs, moisture proof packaging with absorbent material (silica gel) is recommended.

After opening the package:

The LEDs should be kept at 30°C or less and 70%RH or less. The LEDs should be soldered within 72 hours (3days) after opening the package. If unused LEDs remain, they should be stored in moisture proof packages, such as sealed containers with packages of moisture absorbent material (silica gel). It's also recommended to return the LEDs to the original moisture proof bag and to reseal the moisture proof bag again.



Drawing No.	Rev.	Date	Page
SP0605A-3C	B	2023/04/21	1/10

\*If the moisture absorbent material (silica gel) has faded away or the LEDs have exceeded the storage time, baking treatment should be performed using the following condition.

Baking treatment: more than 24 hours at 65+/-5°C

\*Solidlite LED electrode sections are comprised of a silver plated copper alloy. The silver surface may be affected by environments which contain corrosive gases and so on. Please avoid conditions which may cause the LED to corrode, tarnish or discolor. This corrosion or discoloration may cause difficulty during soldering operations. It is recommended that the user use the LEDs as soon as possible.

\*Please avoid rapid transitions in ambient temperature, especially in high humidity environments where condensation can occur.

## 2. Moisture Proof Package

\*When moisture is absorbed into the SMT package it may vaporize and expand during soldering. There is a possibility that this can cause exfoliation of the contacts and damage to the optical characteristics of the LEDs. For this reason, the moisture proof package is used to keep moisture to a minimum in the package.

\*The moisture proof package is made of an aluminum moisture proof bag with a zipper. A package of a moisture absorbent material (silica gel) is inserted into the aluminum moisture proof bag. The silica gel changes its color from blue to pink as it absorbs moisture.

## 3. Heat Generation

\*Thermal design of the end product is of paramount importance. Please consider the heat generation of the LED when making the system design. The coefficient of temperature increase per input electric power is affected by the thermal resistance of the circuit board and density of LED placement on the board, as well as other components. It is necessary to avoid intense heat generation and operate within the maximum ratings given in this specification.

\*The operating current should be decided after considering the ambient maximum temperature of LEDs.

## 4. Static Electricity

\*Static electricity or surge voltage damages the LEDs.

It is recommended that a wrist band or an anti-electrostatic glove be used when handling the LEDs.

\*All devices, equipment and machinery must be properly grounded.

It is recommended that measures be taken against surge voltage to the equipment that mounts the LEDs.

\*When inspecting the final products in which LEDs were assembled, it is recommended to check whether the assembled LEDs are damaged by static electricity or not. It is to find static-damaged LEDs by a light-on or a VF test at a lower current (below 1mA is recommended).



Drawing No.	Rev.	Date	Page
SP0605A-3C	B	2023/04/21	1/10

\*Damaged LEDs will show some unusual characteristics such as the leak current remarkably increases, the forward voltage becomes lower, or the LEDs do not light at the low current.

Criteria:(VF>2.0 V at IF=0.5mA)

## 5. Cleaning

\*It is recommended that isopropyl alcohol be used as a solvent for cleaning the LEDs. When using other solvents, it should be confirmed beforehand whether the solvents will dissolve the package and the resin or not. Freon solvents should not be used to clean the LEDs because of worldwide regulations.

\*Do not clean the LEDs by the ultrasonic. When it is absolutely necessary, the influence of ultrasonic cleaning on the LEDs depends on factors such as ultrasonic power and the assembled condition. Before cleaning, a pre-test should be done to confirm whether any damage to the LEDs will occur.

## 6. Other

\*Care must be taken to ensure that the reverse voltage will not exceed the absolute maximum rating when using the LEDs with matrix drive.

\*The LED light output is strong enough to injure human eyes. Precaution must be taken to prevent looking directly at the LEDs with unaided eyes for more than a few seconds

\*Flashing lights have been known to cause discomfort in people. You can prevent this by taking precautions during use. Also, people should be cautious when using equipment that has had LEDs incorporated into it.

\*The LEDs described in this brochure are intended to be used for ordinary electronic equipment (such as office equipment, communications equipment, measurement instruments and household appliances). Consult Solidlite's sales staff in advance for information on the applications in which exceptional quality and reliability are required, particularly when the failure or malfunction of the LEDs may directly jeopardize life or health (such as for airplanes, aerospace, submersible repeaters, nuclear reactor control systems, automobiles, traffic control equipment, life support systems and safety devices).

\*User shall not reverse engineer by disassembling or analysis of the LEDs without having prior written consent from Solidlite. When defective LEDs are found, the user shall inform Solidlite directly before disassembling or analysis.

\*The formal specifications must be exchanged and signed by both parties before large volume purchased begins.

\*The appearance and specifications of the product may be modified for improvement without notice.