

# User's Guide

## TMAG5x73 Evaluation Modules



### ABSTRACT

This user's guide describes the characteristics, operation, and use of the TMAG5273 evaluation module (EVM) and the TMAG5173 EVM. The TMAG5273 EVM is designed to evaluate the performance of the TMAG5273A1 and TMAG5273A2 device variants. The TMAG5173 EVM is designed to evaluate the performance of the TMAG5173A1 and TMAG5173A2 device variant. Throughout this document, the terms evaluation board, evaluation module, and EVM are synonymous with the TMAG5x73EVM. This document includes a schematic, reference printed circuit board (PCB) layouts, and a complete bill of materials (BOM).

### Table of Contents

<b>1 Overview</b>	3
1.1 Kit Contents	5
1.2 Related Documentation From Texas Instruments	5
<b>2 Hardware</b>	5
2.1 Features	5
<b>3 Operation</b>	6
3.1 Quick Start Setup	6
<b>4 EVM Operation</b>	7
4.1 Setup	8
4.2 Rotate and Push Demo	11
4.3 Joystick Demo	13
4.4 Direct EVM Serial Communication	15
<b>5 Circuitry</b>	17
5.1 TMAG5x73 EVM Components	17
5.2 SCB LEDs	17
<b>6 Schematics, PCB Layout, and Bill of Materials</b>	18
6.1 Schematics	18
6.2 PCB Layout	24
6.3 Bill of Materials	28
<b>7 Revision History</b>	30

### List of Figures

Figure 1-1. TMAG5273 Evaluation Module	3
Figure 1-2. TMAG5173 Evaluation Module	4
Figure 3-1. TMAG5x73 EVM With A1 and A2 Parts of Board Still Joined Together	6
Figure 4-1. Sensor Control Board Connected to A1 Part of EVM	7
Figure 4-2. Sensor Control Board Connected to A2 Part of EVM	7
Figure 4-3. Test Points Used to Enter DFU Mode Manually	8
Figure 4-4. GUI Composer Application Window	9
Figure 4-5. TI Cloud Agent	9
Figure 4-6. Hardware Connected	10
Figure 4-7. Change Serial Port	10
Figure 4-8. Registers Page Icon	10
Figure 4-9. Plots Page Icon	10
Figure 4-10. Rotate & Push Module on EVM	11
Figure 4-11. Rotate & Push GUI Page	12
Figure 4-12. X and Y Channel GUI Plots	12
Figure 4-13. Device's Angle Measurement Plot	12
Figure 4-14. Device's Magnitude Plot	13
Figure 4-15. Joystick Module on EVM	13

Figure 4-16. GUI Before Data Collection Begins With Joystick Module.....	14
Figure 4-17. Example X and Y Channel GUI Plots After Joystick Movement.....	14
Figure 4-18. Example Register Read Response.....	15
Figure 4-19. Example Register Write Response.....	15
Figure 4-20. Example Firmware Revision Command Response.....	16
Figure 4-21. Firmware Revision Version in GUI About Screen.....	16
Figure 4-22. BSL Command Response.....	16
Figure 6-1. TMAG5273A1 Part of EVM Schematic.....	18
Figure 6-2. TMAG5273A2 Part of EVM Schematic.....	19
Figure 6-3. TMAG5273EVM Hardware Schematic.....	20
Figure 6-4. TMAG5173A1 Part of EVM Schematic.....	21
Figure 6-5. TMAG5173A2 Part of EVM Schematic.....	22
Figure 6-6. TMAG5173EVM Hardware Schematic.....	23
Figure 6-7. TMAG5273EVM Top View.....	24
Figure 6-8. TMAG5273EVM Top Layer.....	24
Figure 6-9. TMAG5273EVM Bottom View.....	25
Figure 6-10. TMAG5273EVM Bottom Layer.....	25
Figure 6-11. TMAG5173EVM Top View.....	26
Figure 6-12. TMAG5173EVM Top Layer.....	26
Figure 6-13. TMAG5173EVM Bottom View.....	27
Figure 6-14. TMAG5173EVM Bottom Layer.....	27

### List of Tables

Table 1-1. TMAG5x73 Device Summary.....	4
Table 1-2. Kit Contents.....	5
Table 1-3. Related Documentation.....	5
Table 6-1. TMAG5273EVM Bill of Materials.....	28
Table 6-2. TMAG5173EVM Bill of Materials.....	29

### Trademarks

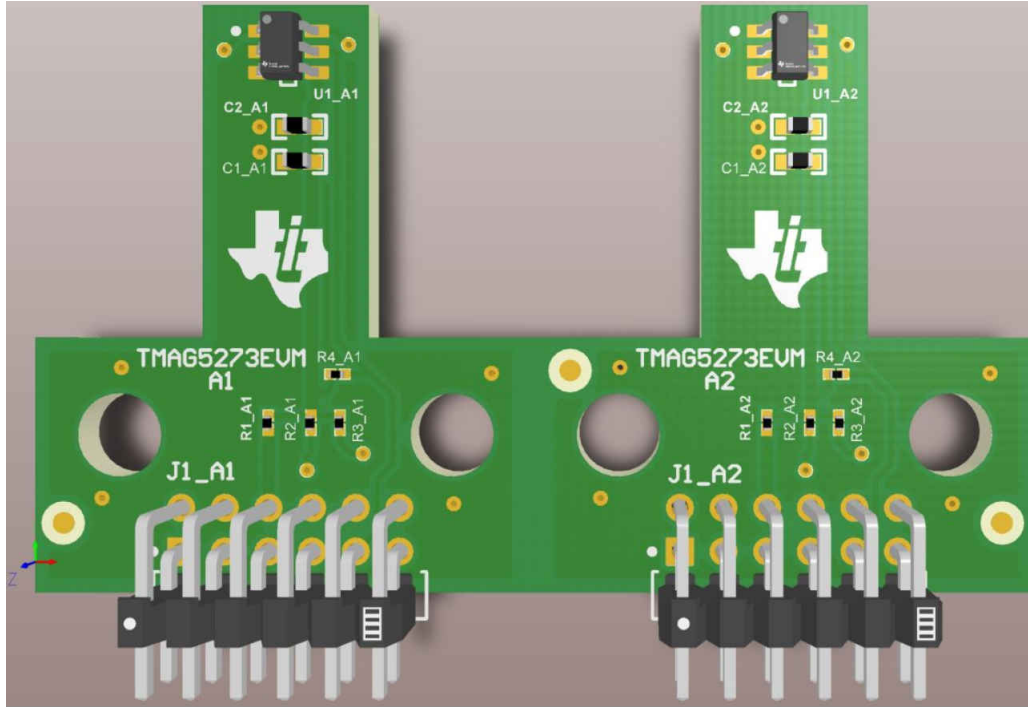
Chrome® is a registered trademark of Google LLC.

Firefox® is a registered trademark of Mozilla Foundation.

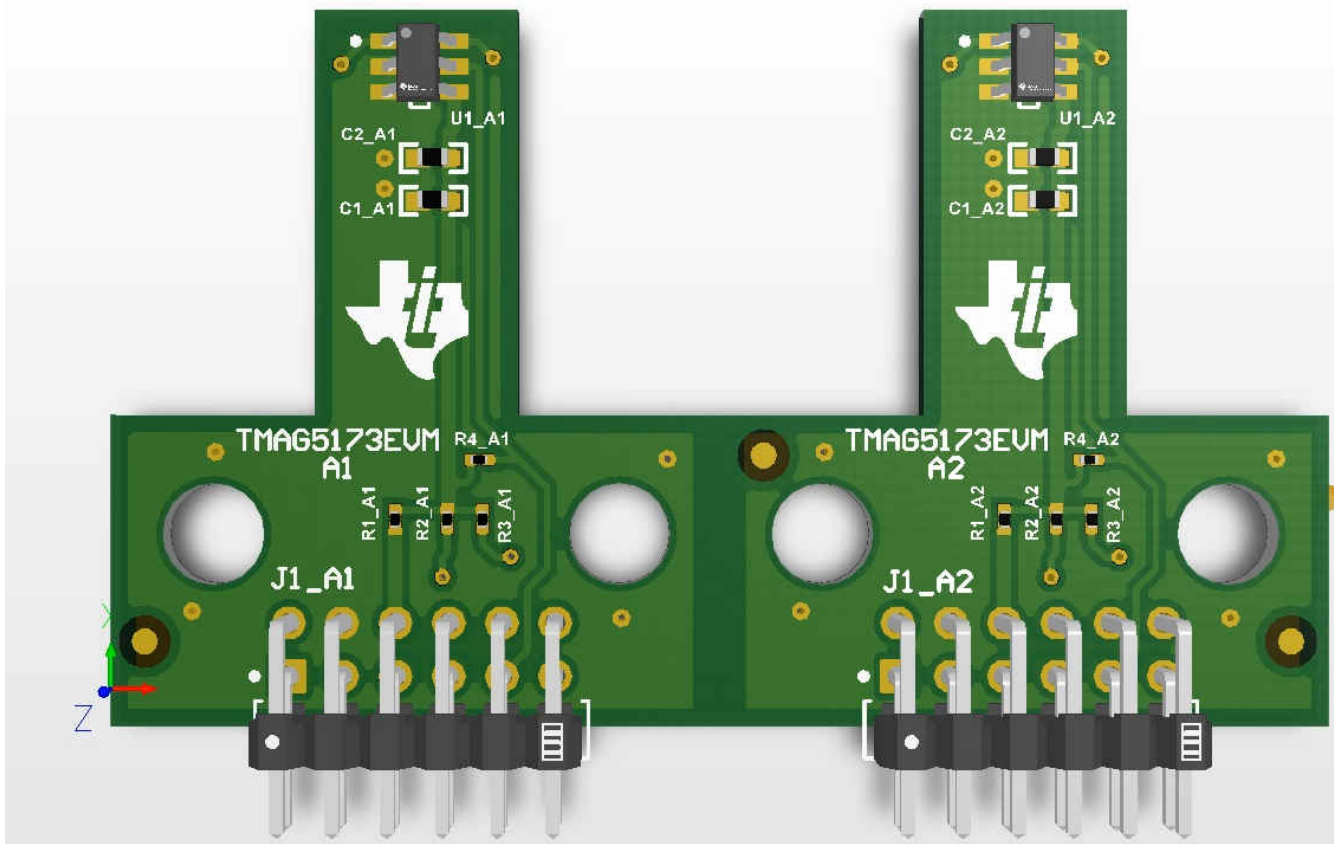
All trademarks are the property of their respective owners.

## 1 Overview

The TMAG5x73 devices are 3-axis (3D) linear Hall-effect sensors. These devices integrate three independent Hall sensors in X, Y, and Z axes. A precision analog signal-chain along with integrated 12-bit ADC digitizes the measured analog magnetic field values. The devices can be configured further to select one of two magnetic field ranges that suits the magnet strength and component placements during system calibration. [Figure 1-1](#) shows the TMAG5273 EVM and [Figure 1-2](#) shows the TMAG5173 EVM.



**Figure 1-1. TMAG5273 Evaluation Module**



**Figure 1-2. TMAG5173 Evaluation Module**

The primary difference between the TMAG5273EVM and TMAG5173EVM PCBs is that only the TMAG5273EVM has the TMAG5273 while the TMAG5173 EVM only has the automotive qualified TMAG5173 device. In addition, the PCB silkscreen on these EVMs have been updated to reference what device is on their board. One other difference between the EVMs is that the TMAG5273EVM comes with the Rotate and Push 3D print module while the TMAG5173EVM comes with the joystick 3D print module. [Table 1-1](#) provides the summary of the sensitivity range options available for the A1 and A2 variants of the TMAG5x73 device. Each device variant supports two different range options that can be selected from in software, where each device variant has a different set of two range options that are supported. Specifically, the A1 variant of the TMAG5x73 supports either a 40-mT or 80-mT range while the A2 variant supports either a 133-mT or 266-mT range. The appropriate range is chosen so that the range is larger than the desired maximum magnetic flux density to sense. If both range options in a device can meet this requirement, selecting the smaller range setting would provide the best accuracy. For example, if the maximum-sensed maximum flux density in a system is 65 mT and the A1 variant of the device is used, select the 80-mT range of the A1 device because the 40-mT range would not be able to sense the maximum magnetic flux density seen in the system. You can select both the 133-mT and 266-mT range options if the A2 device is used in this example instead, but selecting the 133-mT option provides the most accurate measurements.

**Table 1-1. TMAG5x73 Device Summary**

PRODUCT	SENSITIVITY RANGE OPTIONS
TMAG5x73A1	±40 mT, ±80 mT
TMAG5x73A2	±133 mT, ±266 mT

## 1.1 Kit Contents

Table 1-2 lists the contents of the EVM kits. Contact the nearest [Texas Instruments Product Information Center](#) if any component is missing.

**Table 1-2. Kit Contents**

ITEM	QUANTITY
TMAG5x73EVM	1
Handheld magnet	2
Rotate and push 3D print module (TMAG5273EVM only)	1
Joystick 3D print module (TMAG5173EVM only)	1

## 1.2 Related Documentation From Texas Instruments

This user's guide is available from the TI website under literature number [SLYU058](#). Any letter appended to the literature number corresponds to the document revision that is current at the time of the writing of this document. Newer revisions are available from [www.ti.com](#) or the Texas Instruments' Literature Response Center at (800) 477-8924 or the Product Information Center at (972) 644-5580. When ordering, identify the document by both title and literature number. Table 1-3 lists documentation related to the EVM. Click the links in Table 1-3 for further information. The device name links to the product web folder on [www.ti.com](#). The literature number links to the document PDF.

**Table 1-3. Related Documentation**

DOCUMENT TITLE	DOCUMENT LITERATURE NUMBER
<a href="#">TMAG5273 data sheet</a>	<a href="#">SLYS045</a>
<a href="#">TMAG5173 data sheet</a>	<a href="#">SBASA79</a>

## 2 Hardware

The EVMs are an easy-to-use platform for evaluating the main features and performance of the TMAG5x73 devices. The EVM includes a graphical user interface (GUI) used to read and write registers, as well as view and save measurement results. The TMAG5273EVM also includes a 3D printed Rotate & Push Module to test the common functions of angle measurement and push button with a single device. Instead of the Rotate & Push Module, the TMAG5173EVM contains the joystick module.

The EVMs are intended to provide basic functional evaluation of the devices. The layout is not intended to be a model for the target circuit, nor is it laid out for electromagnetic compatibility (EMC) testing. The Sensor Controller Board (SCB) interfaces the EVM to the PC GUI. Please note that the SCB, TMAG5273EVM, and TMAG5173EVM are all sold separately. The TMAG5x73 EVM PCBs can be broken in half across the score line so that the TMAG5x73A1 parts of the EVM are on one PCB and the TMAG5x73A2 parts of the EVM are on the other PCB.

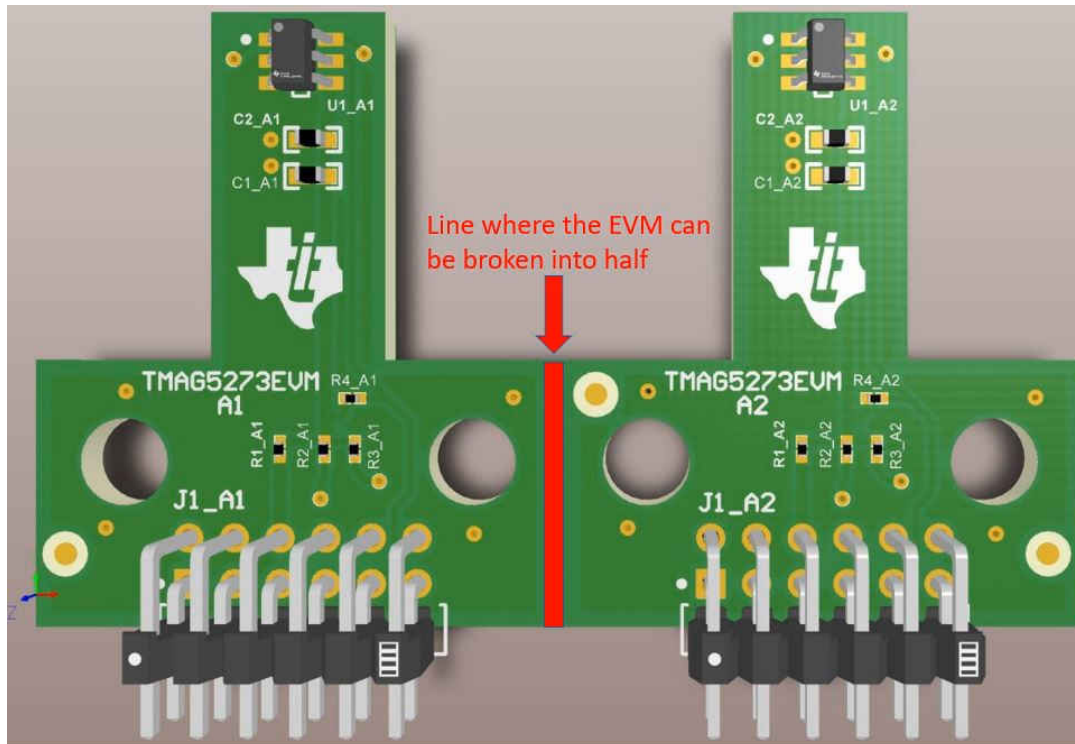
### 2.1 Features

These EVMs include the following features:

- GUI support to read and write device registers, as well as view and save measurement results
- 3D print rotate and push module or 3D print joystick module
- Detachable EVM for custom use cases
- Conveniently powered from a common micro USB connector

## 3 Operation

### 3.1 Quick Start Setup



**Figure 3-1. TMAG5x73 EVM With A1 and A2 Parts of Board Still Joined Together**

To set up and use the EVM, follow these steps:

1. Gently flex the panel at the score line shown in [Figure 3-1](#) to split the board in half for a more compact form factor. This split provides separate boards for the TMAG5x73A1 and TMAG5x73A2 portions of the original board.
2. Download and install the driver as a one-time step per PC: <http://www.ti.com/lit/zip/sbac253>
3. Attach the EVM to the Sensor Control Board (SCB). To evaluate the TMAG5x73A1 on the EVM, attach header J1 of the Sensor Controller board to header J1\_A1 of the EVM (see [Figure 4-1](#)). To evaluate the TMAG5x73A2 on the EVM, attach header J1 of the Sensor Controller board to header J1\_A2 of the EVM (see [Figure 4-2](#)).
4. Use a USB cable to connect the SCB to a PC
  - a. Insert the micro USB cable into the USB receptacle J2 that is on the SCB Controller onboard.
  - b. Plug the other end of the USB cable into a PC.
5. Access the GUI in either the Google Chrome® or Firefox® browser by clicking on the following link: [https://dev.ti.com/gallery/info/7472171/TMAG5x73EVM\\_GUI/ver/2.0.0/](https://dev.ti.com/gallery/info/7472171/TMAG5x73EVM_GUI/ver/2.0.0/)
6. To quickly view results on the GUI, do the following:
  - a. Modify the MAG\_CH\_EN bits in the SENSOR\_CONFIG\_1 register to enable the desired channels to read from. The GUI has drop-down boxes to configure these bits when the SENSOR\_CONFIG\_1 register is selected in the register tab of the GUI.
  - b. Select the desired result plots under the *Results to collect/show* box in the *Results Data* tab, and press *Collect Data* to trigger the read.

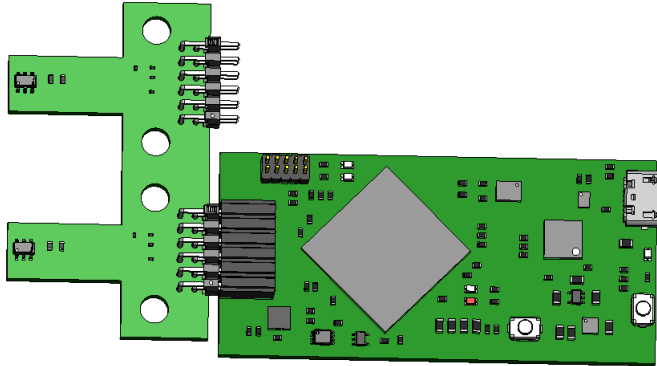
These two steps are the minimum steps needed to see results in the GUI. However, this assumes that the default register settings are used for the other registers. For more custom settings, modify the corresponding register bits according to the system requirements.

7. Apply a magnetic field to the sensor by doing one of the following:
  - a. Wave the included handheld magnet around the sensor.

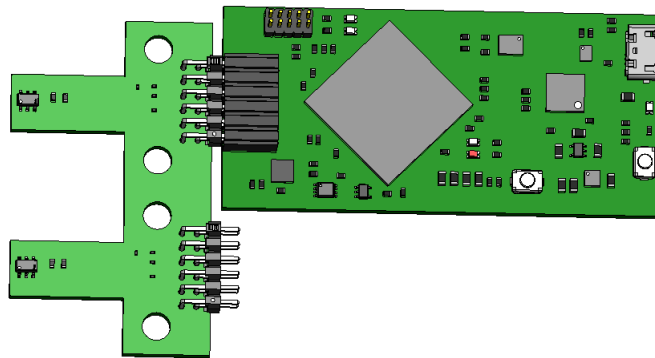
- b. Attach either the Rotate & Push module or the Joystick module to the EVM (see [Figure 4-10](#) and [Figure 4-15](#)). For more details on how to use these modules, see [Section 4.2](#) and [Section 4.3](#).
8. Observe the outputs in the GUI. See [Section 4.1.3](#) for more information on GUI setup and operation.

## 4 EVM Operation

[Figure 4-1](#) and [Figure 4-2](#) show how to connect the EVM to the included SCB.



**Figure 4-1. Sensor Control Board Connected to A1 Part of EVM**



**Figure 4-2. Sensor Control Board Connected to A2 Part of EVM**

## 4.1 Setup

### 4.1.1 Driver Installation

Download and install this driver: <http://www.ti.com/lit/zip/sbac253>. This is a one-time step per computer. Unzip the folder and run the .exe file with administrator privileges.

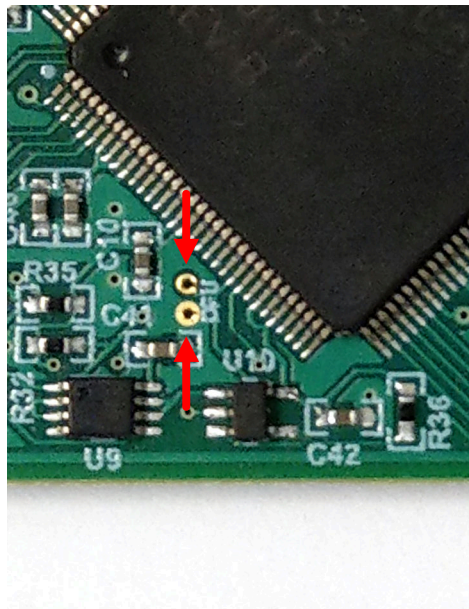
### 4.1.2 Firmware

The firmware must be flashed onto the SCB to properly communicate to the TMAG5x73EVMs. After flashing the SCB with the TMAG5x73EVM, the firmware does not have to be reflashed on the SCB as long as the firmware is not erased or replaced with the firmware for a different EVM. If the firmware is erased or replaced, the TMAG5x73EVM firmware must be flashed onto the SCB again to communicate to the TMAG5x73EVMx. The latest version of the firmware can be downloaded from: <https://www.ti.com/lit/zip/sbac295>.

#### 4.1.2.1 Updating Firmware on SCB

Follow these steps to install the firmware.

1. Configure the MCU on the SCB to be in Device Firmware Update (DFU) Mode. DFU mode can be entered manually through one of the following methods while the SCB is powered on:
  - a. Through software:
    - Send the command "bsl" on the SCB's USB Serial (COM) port.
  - b. Through hardware (with the EVM removed):
    - Short the two test points labeled *DFU* (see [Figure 4-3](#)) with a pair of tweezers (or wire) while pressing the RESET button. If this is done correctly, LED D1 on the SCB should turn off while the LED D5 (the power LED) remains on. If LED D1 is still on, the GUI firmware is still active and the device has not entered DFU mode.



**Figure 4-3. Test Points Used to Enter DFU Mode Manually**

2. With the MCU in DFU mode, the firmware can now be uploaded through the USB Bootstrap Loader (BSL) scripiter tool and batch file by doing the following:
  - a. Download the firmware package and BSL scripiter tool from the EVM page, or use the link: <https://www.ti.com/lit/zip/sbac295>
  - b. Unzip the firmware folder and run the .bat file.
  - c. Unplug the USB cable from the PC after the firmware is flashed, then plug the cable back in to reset the SCB.



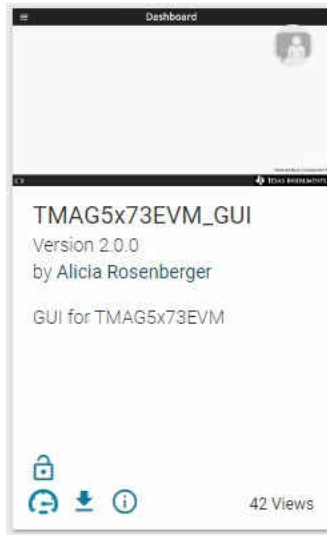
### 4.1.3 GUI Setup and Usage

Access the GUI in either the Google Chrome® or Firefox® browser by clicking on the following link: [https://dev.ti.com/gallery/info/7472171/TMAG5x73EVM\\_GUI/ver/2.0.0/](https://dev.ti.com/gallery/info/7472171/TMAG5x73EVM_GUI/ver/2.0.0/)

#### 4.1.3.1 Initial Setup

To set up the GUI the first time, follow these steps:

1. Make sure that the previously-mentioned driver was installed successfully to ensure that everything works properly.
2. Plug the connected EVM and SCB unit to the PC and go to the [GUI link](#) provided earlier.
3. Click the GUI Composer application window shown in [Figure 4-4](#) to launch the GUI from the web browser.



**Figure 4-4. GUI Composer Application Window**

- For first-time GUI Composer setup, follow the prompts to download the *TI Cloud Agent* and browser extension shown in [Figure 4-5](#). These prompts will appear after you close the README.md dialog.

## TI Cloud Agent Installation

Hardware interaction requires additional one time set up. Please perform the actions listed below and try your operation again. (What's this?)

- Step 1: **INSTALL** browser extension
- Step 2: **DOWNLOAD** and install the TI Cloud Agent Application
- Help. I already did this

**FINISH**

**Figure 4-5. TI Cloud Agent**

4. Click the  icon in the *GUI Composer* window shown in [Figure 4-4](#) to download the GUI offline (optional).

### 4.1.3.2 GUI Operation

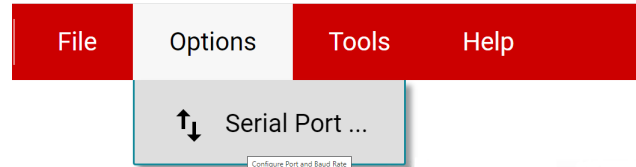
To operate the GUI, follow these steps:

1. Connect to and launch the GUI as described in [Section 4.1.3.1](#).
2. Close the README.md file page that pops up after the EVM connects to the GUI. The text near the bottom-left hand corner of the GUI should read *Hardware Connected*.




**Figure 4-6. Hardware Connected**

- a. If *Hardware Connected* does not show in the bottom-left hand corner of the GUI, check different hardware COM ports under *Options >> Serial Port*.



**Figure 4-7. Change Serial Port**

- b. If the hardware still does not connect, make sure you are using the correct GUI and EVM combination.
3. Click the *Registers* icon shown in [Figure 4-8](#) (also available on the left-side menu) to view the register map, change device settings, and enable automatic register read. For questions about a register or register bit field, select the  icon. For more questions about registers, check the data sheet.



**Figure 4-8. Registers Page Icon**

4. Click the *Plots* icon shown in [Figure 4-9](#) (also available on the left-side menu) to view and save graphical data from the results registers. This screen shows the x-axis, y-axis, z-axis, angle, magnitude and temperature plots that are derived from the corresponding TMAG5x73 result registers. These plots have been converted to real world units of mT and degrees. Click the *SAVE PLOT* button on the corresponding plot to save any specific plot.

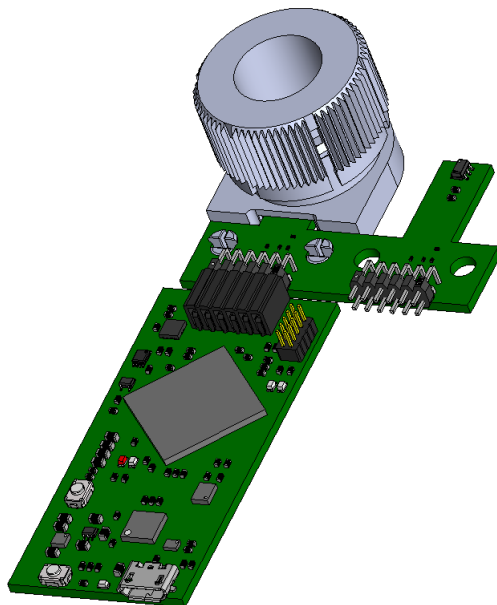


**Figure 4-9. Plots Page Icon**

## 4.2 Rotate and Push Demo

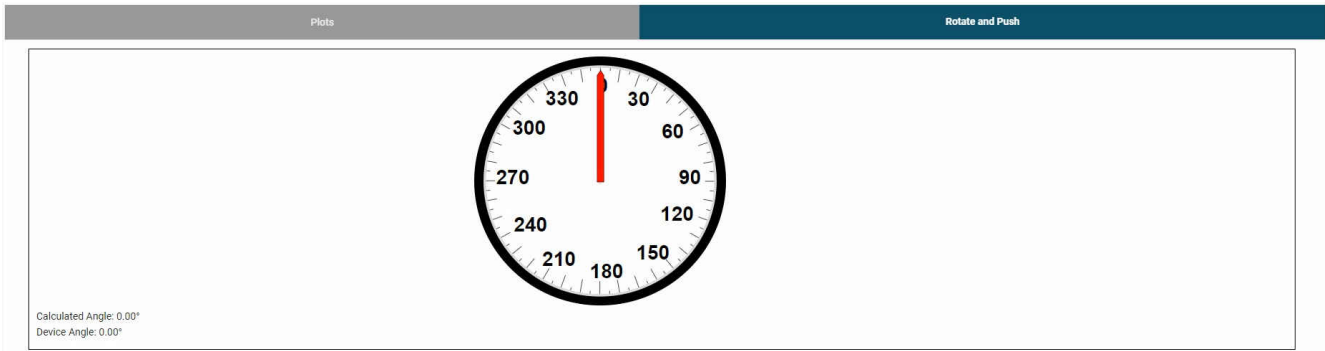
The TMAG5273EVM comes with the rotate and push 3D print; however, this 3D print could also work with the TMAG5173 since both devices use the same magnetic range. To use the Rotate & Push Demo, follow these steps:

1. Attach the Rotate & Push Module to the EVM (see [Figure 4-10](#) for an example on how this module is connected to the A1 part of the EVM).



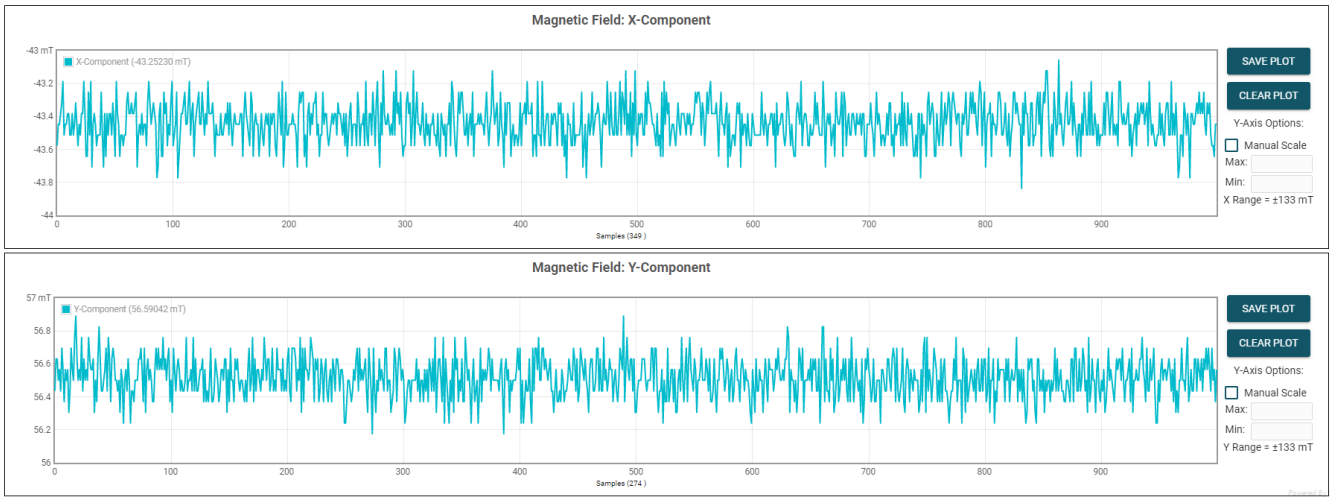
**Figure 4-10. Rotate & Push Module on EVM**

2. In the GUI register page:
  - a. Select the `DEVICE_CONFIG2` register and check the following:
    - i. Make sure the drop-down menu option for the `OPERATING_MODE` register bits says `00b = Standby Mode`
    - ii. Make sure the drop-down menu option for the `TRIGGER_MODE` register bits says `0b=Conversion Start at I2C Command Bits`
  - b. Click the `SENSOR_CONFIG1` register and select the `0011b= X, Y channel enabled` option under the `MAG_CH_EN` drop-down menu to enable the X and Y channels.
  - c. Click the `SENSOR_CONFIG2` register and set the `X_Y_RANGE` drop-down menu to one of the below options (note that the same range option will be selected for the X and Y axes; however, the Z axis range can be set independently of the x and y axes range setting):
    - i. If the TMAG5273A1 part of the EVM is connected to the SCB, select the `1b = ±80 mT (TMAG5273x1)/ ±266mT (TMAG5273x2)` option. This will ensure that the 80-mT variant is selected for the TMAG5273A1. Note that the demo will not work with the 40-mT range because the magnetic flux density produced by the Rotate & Push Module is greater than 40 mT, which is why the 80-mT range is selected.
    - ii. If the TMAG5273A2 part of the EVM is connected to the SCB, select the `0b = ±40 mT (TMAG5273x1)/ ±133mT (TMAG5273x2)` option. This will ensure that the 133-mT range option is selected. The 266 mT could also be used here instead, but the results using this range would not be as good as the results with the 133-mT range.
  - d. Optional: Click the `SENSOR_CONFIG2` register and set the `ANGLE_EN` drop-down menu to `01B = X 1ST, y 2ND`. Performing this step enables the TMAG5273's angle measurement calculation.
  - e. Set the `Auto Read` at the top of the register map to `As fast as possible`.
3. Go to the *Rotate & Push* tab inside the plots page (see [Figure 4-11](#)).

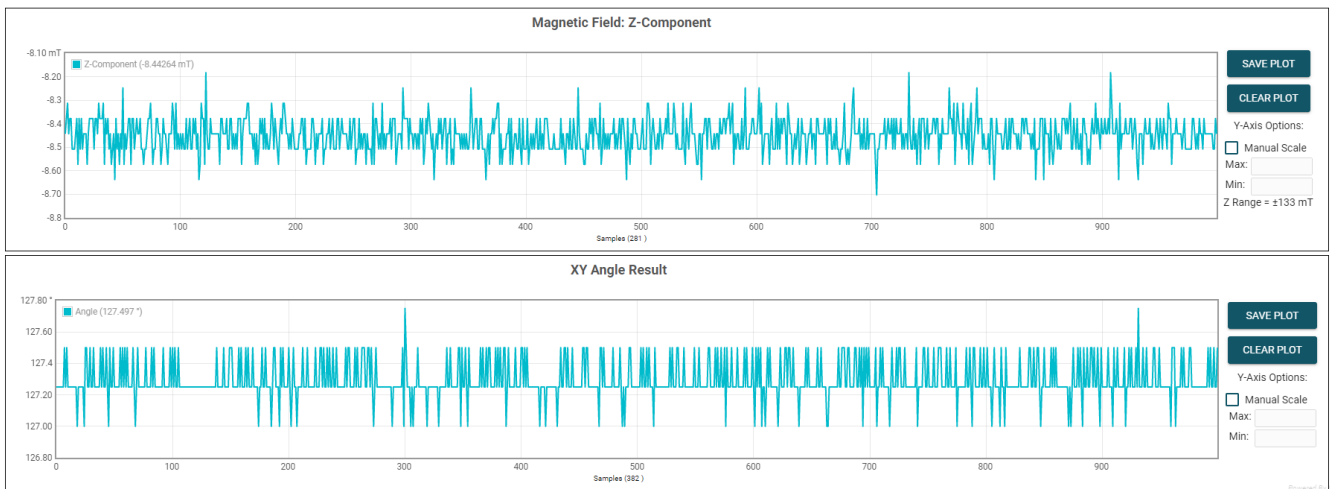


**Figure 4-11. Rotate & Push GUI Page**

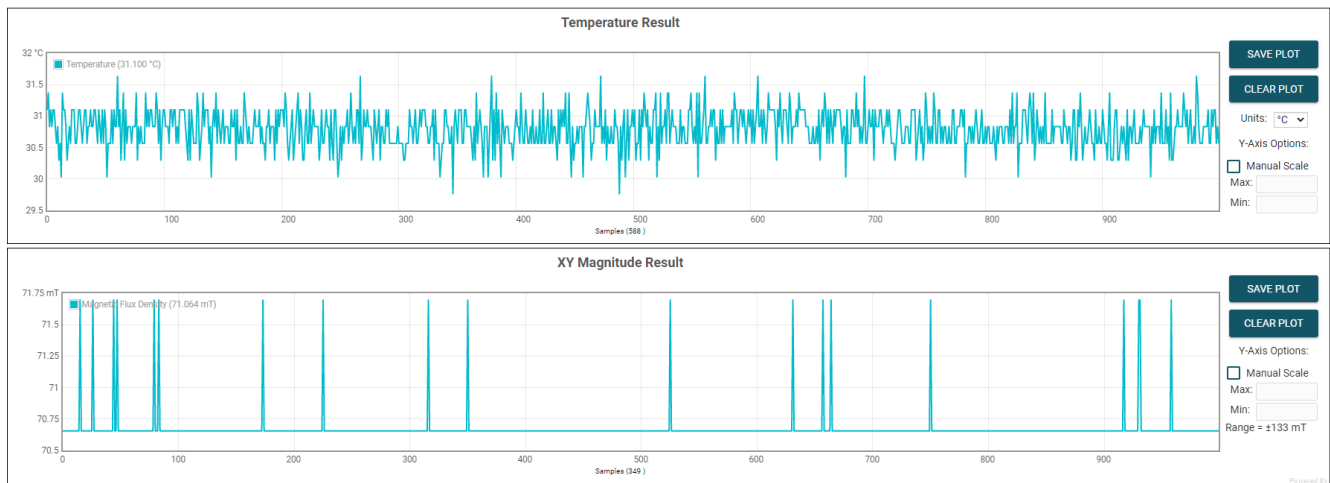
- As the user turns the knob on the Rotate & Push Module, the angle displayed on the dial and text below the dial changes accordingly. Click the *Plots* tab to see the resulting X and Y channel waveforms (Figure 4-12), device angle measurement (Figure 4-13), and magnitude (Figure 4-14) during this process.



**Figure 4-12. X and Y Channel GUI Plots**



**Figure 4-13. Device's Angle Measurement Plot**



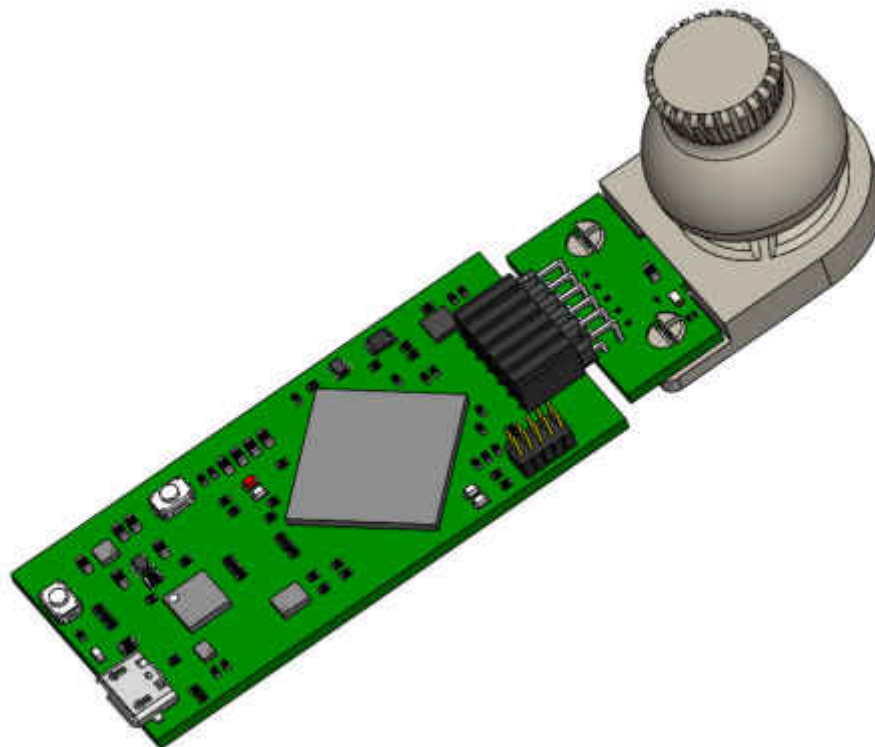
**Figure 4-14. Device's Magnitude Plot**

5. Press the *STOP COLLECT* button to stop collecting data.
6. After testing a particular TMAG5x73 device variant, make sure to first disconnect the SCB USB cable from the PC before connecting the SCB to another part of the EVM board associated with the other TMAG5x73 device variant. After disconnecting the cable, the part of the EVM board associated with the other TMAG5x73 variant should be connected to the SCB before reconnecting the SCB USB cable to the PC.

### 4.3 Joystick Demo

The TMAG5173EVM comes with the Joystick 3D print; however, this 3D print could also work with the TMAG5273 since both devices use the same magnetic range. To use the joystick demo, follow these steps:

1. Attach the joystick module to the EVM. See [Figure 4-15](#) for an example on how this module is connected to one of the two TMAG5173 EVM parts.



**Figure 4-15. Joystick Module on EVM**

2. In the GUI register page:

- a. Select the *DEVICE\_CONFIG2* register and check the following:
    - i. Make sure that drop-down menu option for the *OPERATING\_MODE* register bits says *00b = Standby Mode (starts new conversion at trigger event)*
    - ii. Make sure that drop-down menu option for the *TRIGGER\_MODE* register bits says *0b=Conversion Start at I2C Command Bits*
  - b. Click the *SENSOR\_CONFIG1* register and select the *0011b= X, Y channel enabled* option under the *MAG\_CH\_EN* drop-down menu to enable the X and Y channels. You can also select the *0111b= X, Y, Z channel enabled* option to enable the Z channel, but only the X and Y channels are required to observe the effect of the motion of the joystick. If the Z channel is enabled, remember that this channel sees larger fields than the X and Y channel. Select the *1b = ±80 mT (TMAG5x73A1)/ ±266mT (TMAG5X73A2)* option under the *Z\_RANGE* register bit drop-down menu to ensure the *Z\_RANGE* bit in the *SENSOR\_CONFIG2* register is set to 1.
3. Go to the *Plots* tab within the *Results Data* page. Ensure that at least the X Component and Y Component checkboxes are selected under the *Results to collect/show* box, then press the *COLLECT DATA* button shown in [Figure 4-16](#).



**Figure 4-16. GUI Before Data Collection Begins With Joystick Module**

- a. When the user moves the joystick around, the X and Y readings change:



**Figure 4-17. Example X and Y Channel GUI Plots After Joystick Movement**

- i. Note that different joysticks may have different magnetic readings for a specific joystick position due to differences in the installation position of the spherical magnet within the joystick; however, this can be dealt with by mapping the different joystick positions to the magnetic flux density readings during calibration, similar to the approach shown in this video: <https://training.ti.com/designing-joysticks-hall-effect-sensors>
4. Press the *STOP COLLECT* button to stop collecting data.
5. After testing a particular TMAG5x73 device variant, make sure to first disconnect the SCB USB cable from the PC before connecting the SCB to another part of the EVM board associated with the other TMAG5x73 device variant. After disconnecting the cable, the part of the EVM board associated with the other TMAG5x73 variant should be connected to the SCB before reconnecting the SCB USB cable to the PC.

#### 4.4 Direct EVM Serial Communication

If desired, the SCB can communicate directly with the EVM without the use of the GUI through the USB serial (COM) port. Simply send the desired command string over the serial port and receive the results. This is useful for interfacing the EVM with custom setups/scripts/GUIs. Note that the TMAG5x73EVM must be connected to the SCB to receive any command responses from the SCB.

To read and write registers, follow the below format:

- Read register command format: **rreg ADR**
  - Where ADR is the address in hex, and rreg is always lower case
  - Register addresses can be in upper or lower case, and do not need to be led by "0x". 0 padding register addresses is also optional. For example, to read register address 0xE, some valid commands include:
    - rreg e
    - rreg 0E
    - rreg 0x0E
      - When "0x" is used, the "x" must be lower case.
  - [Figure 4-18](#) is an example response to this command:

```
{"acknowledge":"rreg 0xE"}
{"register":{"address":14,"value":21577}}
{"evm_state":"idle"}
```

**Figure 4-18. Example Register Read Response**

The number to the right of value represents the value read from the register. Note that this value is represented in decimal form and not hexadecimal.

- Write register command format: **wreg ADR VAL**
  - Where ADR and VAL are in hex, and wreg is always lower case
  - Register addresses and values can be in upper or lower case, and do not need to be led by "0x". 0 padding register addresses and values is also optional. For example, to write register address 0x0 with the value 4, some valid commands include:
    - wreg 0 4
    - wreg 00 0x4
    - wreg 0x00 0x04
      - When "0x" is used, the "x" must be lower case.
  - [Figure 4-19](#) is an example response to this command:

```
{"acknowledge":"wreg 0x00 0x04"}
{"console":"Writing 0x0004 to DEVICE_CONFIG_1 register"}
{"evm_state":"idle"}
```

**Figure 4-19. Example Register Write Response**

Other useful commands include the following:

- Firmware revision command format: **id**
  - This command prints the EVM the SCB is configured for (TMAG5273EVM in this case) and the date associated with the version of the firmware loaded on the SCB.
  - [Figure 4-20](#) is an example response to this command:

```
{ "acknowledge": "id" }
{ "id": { "name": "TMAG5x73A1EVM", "version": "2.0.0.0", "date": "Aug  2 2022", "time": "13:58:17" } }
{ "evm_state": "idle" }
```

**Figure 4-20. Example Firmware Revision Command Response**

- The date and time obtained from this command is the same date and time that appears in the GUI's *About* screen (see [Figure 4-21](#)). Click the *About* option under the GUI's *Help* menu to view the *About* screen.

### About TMAG5x73EVM\_GUI...

Application Name: TMAG5x73EVM\_GUI  
Version: 2.0.0  
Published Date: Thu, 11 Aug 2022 16:21:25 GMT

Installed Software:

Name	Version	More Info...
polymer	v1.10.1	<a href="https://www.polymer-project.org/1.0/docs/devguide/feature-overview">https://www.polymer-project.org/1.0/docs/devguide/feature-overview</a>
GUI Composer Manifest		<a href="docs/GUI_Composer_manifest.html">docs/GUI_Composer_manifest.html</a>
GUI Composer License		<a href="docs/TSPA_Modified.pdf">docs/TSPA_Modified.pdf</a>
Application Manifest		TMAG5x73EVM_GUI_2.0_manifest.html
Application License		GUI_Composer_Standalone_Software_License_Agreement.pdf

Connected Hardware Details:

```
--- Firmware ---
Name      : TMAG5x73A2EVM
Date/Time : Aug 11 2022 10:28:59
Version   : 2.0.0.0
Timestamp : 20220811102859

--- EVM ---
Device    : TMAG5x73A2
Board     : TMAG5x73A2EVM

--- Controller ---
Host      : SCB
Board     : 5ENS077
Revision  : A
Serial #  : T20L09K1625
```

Visit <http://dev.ti.com/gc> Powered By GUI Composer™v2  
CLOSE

**Figure 4-21. Firmware Revision Version in GUI About Screen**

- BSL command format: **bsl**
  - This command puts the device in BSL mode, which is necessary before reflashing the SCB firmware. An alternative to entering BSL mode is to do it in hardware as described in step 1b of [Section 4.1.2.1](#). Before BSL is entered, LED D1 is on. If BSL mode is successfully entered, LED D1 is turned off so that only the Power LED (LED D5) is on. After entering BSL mode, the device does not accept any of the above commands.
  - [Figure 4-22](#) shows an example response to this command:

```
{ "acknowledge": "bsl" }
```

**Figure 4-22. BSL Command Response**

- Trigger conversion command format: **rreg 0**
  - If the device is in standby mode and new conversions are set to be triggered through I2C, doing a register read at register 0 automatically starts a new set of conversions.



## 5 Circuitry

This section summarizes the EVM subsystems and their components.

### 5.1 TMAG5x73 EVM Components

This section describes the main TMAG5x73 devices and supporting components. The component footprints that are duplicated on both the A1 and A2 parts of the board, have an `_A1` or `_A2` appended to the end of their component names to indicate whether the component is on the A1 or A2 part of the board. With the exception of components `U1_A1` and `U1_A2`, which correspond to different TMAG5x73 device variants, all other `_A1` components use the same components as the corresponding `_A2` components.

The EVM has the following components:

- `U1_A1` is the TMAG5x731A1 device on the A1 part of the board and `U1_A2` is the TMAG5x73A2 device on the A2 part of the board.
- `C1_A1`, `C1_A2`, `C2_A1`, and `C2_A2` are bypass capacitors that are placed near the sensor to help mitigate power-supply noise and provide current quickly to the device when needed.
- `J1A_A1` and `J1B_A1` are the main header pins that connect the digital and power pins of the TMAG5x73A1 to the SCB Controller. Similarly, `J1A_A2` and `J1B_A2` are the main header pins that connect the digital and power pins of the TMAG5x73A2 to the SCB controller.
- Resistors `R1_A1` and `R1_A2` connect the 3.3-V rail from the SCB board to the TMAG5x73A1 and TMAG5x73A2. Remove these resistors if you wish to power the TMAG5273 from a different power source.
- Resistors `R2_A1` and `R2_A2` are the pullup resistors on the SCL pin of the TMAG5x73 devices. Similarly, resistors `R3_A1` and `R3_A2` are the pullup resistors on the SDA pin of the TMAG5x73 devices. `R4_A1` and `R4_A2` are the pullup resistors on the interrupt pin of the TMAG5x73 devices.

### 5.2 SCB LEDs

Three LEDs on the SCB board are used to indicate status:

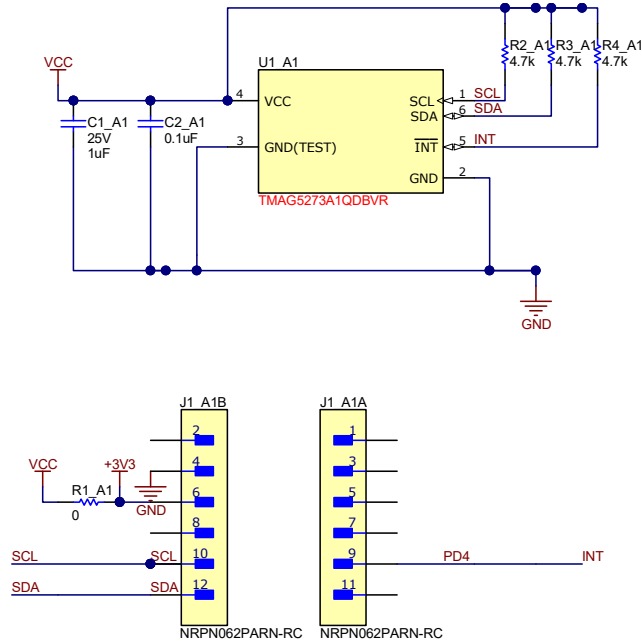
- LED `D5` is a green LED that is ON whenever the USB is connected to the SCB, which would also power the SCB and any connected TMAG5x73 devices.
- LED `D4` is a red LED that indicates the status of the INT pin of the connected TMAG5x73 device. The SCB firmware polls the state of the TMAG5x73 INT pin and turns on the LED `D4` when the TMAG5x73 INT pin is asserted low. This LED is an easy way to visually observe the state of the TMAG5x73 INT pin if the TMAG5x73 is configured to either provide interrupts to indicate that data is ready or if it is configured to indicate that a user-defined magnetic threshold has been surpassed.
- LED `D1` is a green LED that indicates that the TMAG5x73 EVM firmware is loaded on the board and the EVM is not in DFU mode. If the EVM enters DFU mode, whether through software or hardware, this LED is turned off while the LED `D5` remains on.

## 6 Schematics, PCB Layout, and Bill of Materials

### Note

Board layouts are not to scale. These figures are intended to show how the board is laid out. The figures are not intended to be used for manufacturing EVM PCBs.

### 6.1 Schematics

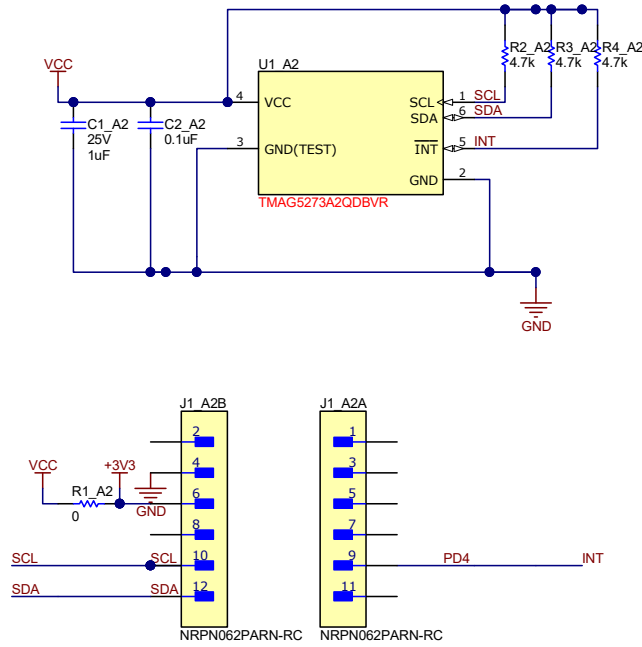


PCB  
LOGO  
Texas Instruments



PCB  
LOGO  
WEEE logo

Figure 6-1. TMAG5273A1 Part of EVM Schematic



PCB  
LOGO  
Texas Instruments



PCB  
LOGO  
WEEE logo

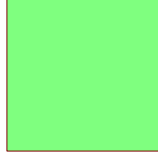
**Figure 6-2. TMAG5273A2 Part of EVM Schematic**

H1 <b>MECH</b> SENS077	H2 <b>MECH</b> 6612041	H3 <b>MECH</b> D2X0	H4 <b>MECH</b> D82DIA	H5 <b>MECH</b> Rotate&PushModule
------------------------------	------------------------------	---------------------------	-----------------------------	----------------------------------------

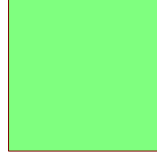
 FID1	 FID2	 FID3
----------------------------------------------------------------------------------------	----------------------------------------------------------------------------------------	----------------------------------------------------------------------------------------

PCB Number: SENS078  
PCB Rev: B

A1  
SENS078B\_Schematic.SchDoc



A2  
SENS078B\_Schematic.SchDoc



ZZ1

**Assembly Note**

These assemblies are ESD sensitive, ESD precautions shall be observed.

ZZ2

**Assembly Note**

These assemblies must be clean and free from flux and all contaminants. Use of no clean flux is not acceptable.

ZZ3

**Assembly Note**

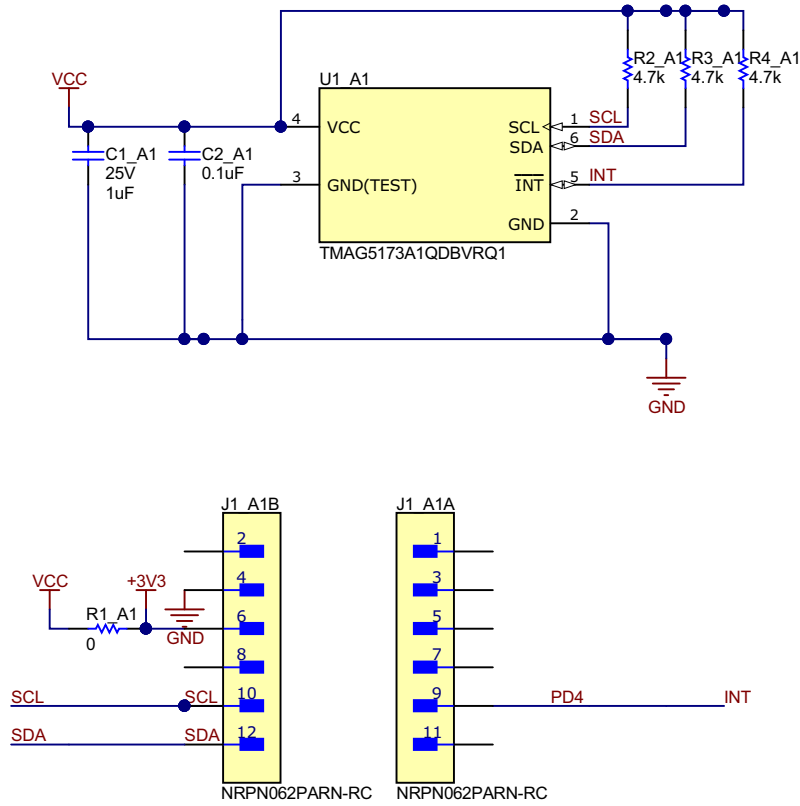
These assemblies must comply with workmanship standards IPC-A-610 Class 2, unless otherwise specified.

ZZ4

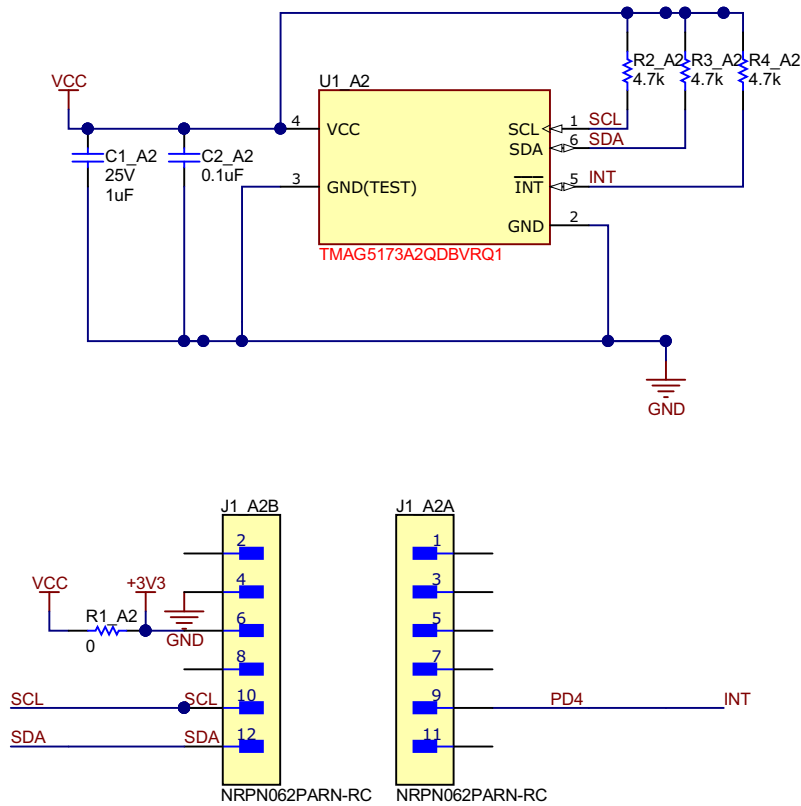
**Assembly Note**

The boards should be shipped connected together. Please do not break the board into two by cutting on the score line.

**Figure 6-3. TMAG5273EVM Hardware Schematic**



**Figure 6-4. TMAG5173A1 Part of EVM Schematic**



PCB  
LOGO  
Texas Instruments



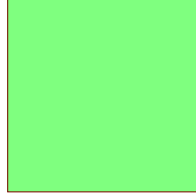
PCB  
LOGO  
WEEE logo

**Figure 6-5. TMAG5173A2 Part of EVM Schematic**

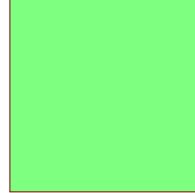


PCB Number: SENS098  
PCB Rev: A

A1  
SENS098A\_Schematic.SchDoc



A2  
SENS098A\_Schematic.SchDoc



ZZ1

Assembly Note

These assemblies are ESD sensitive, ESD precautions shall be observed.

ZZ2

Assembly Note

These assemblies must be clean and free from flux and all contaminants. Use of no clean flux is not acceptable.

ZZ3

Assembly Note

These assemblies must comply with workmanship standards IPC-A-610 Class 2, unless otherwise specified.

ZZ4

Assembly Note

The boards should be shipped connected together. Please do not break the board into two by cutting on the score line.

**Figure 6-6. TMAG5173EVM Hardware Schematic**

## 6.2 PCB Layout

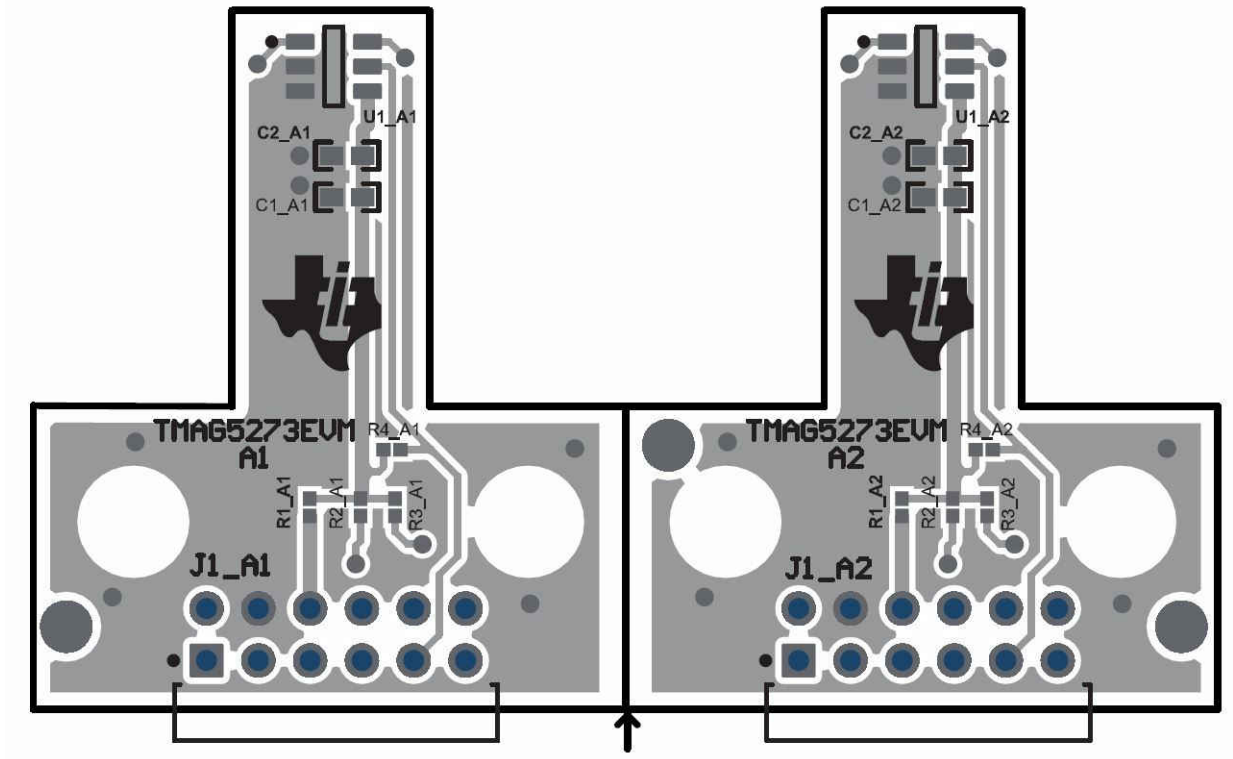


Figure 6-7. TMAG5273EVM Top View

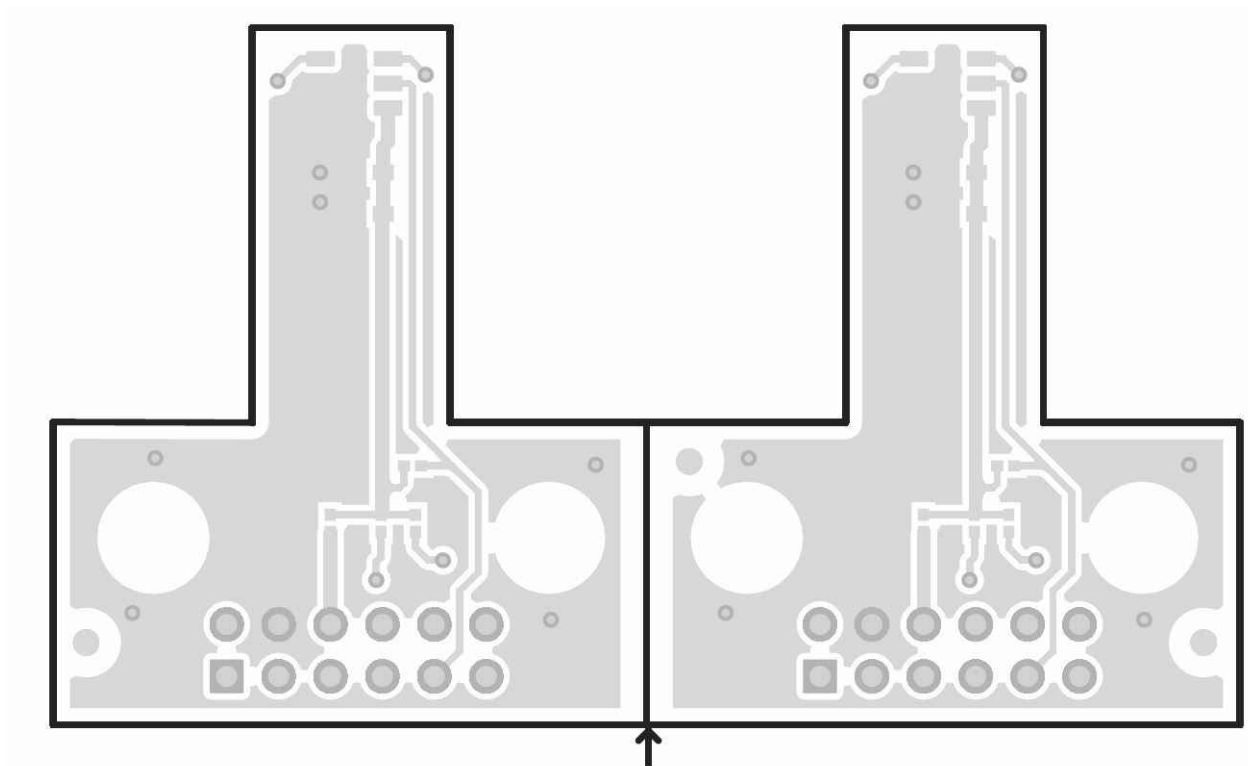


Figure 6-8. TMAG5273EVM Top Layer



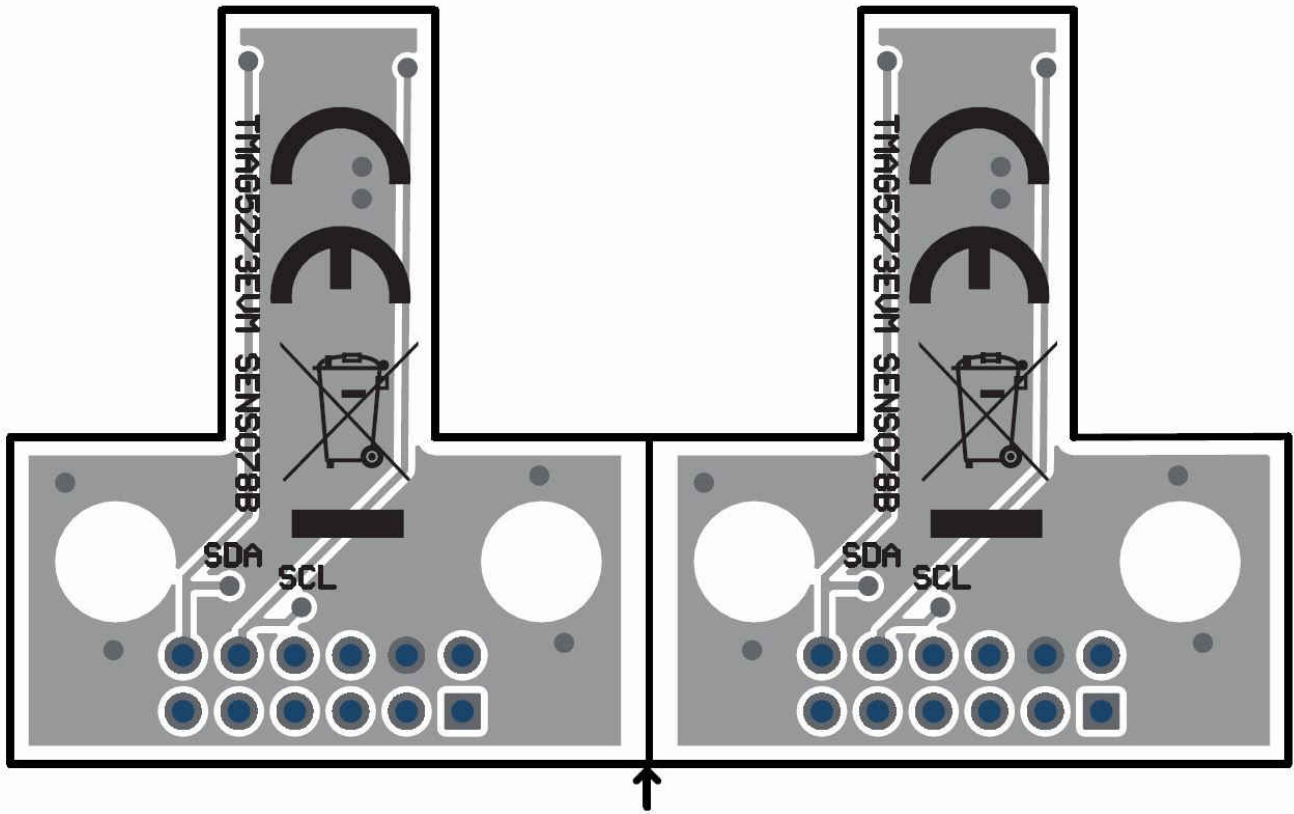


Figure 6-9. TMAG5273EVM Bottom View

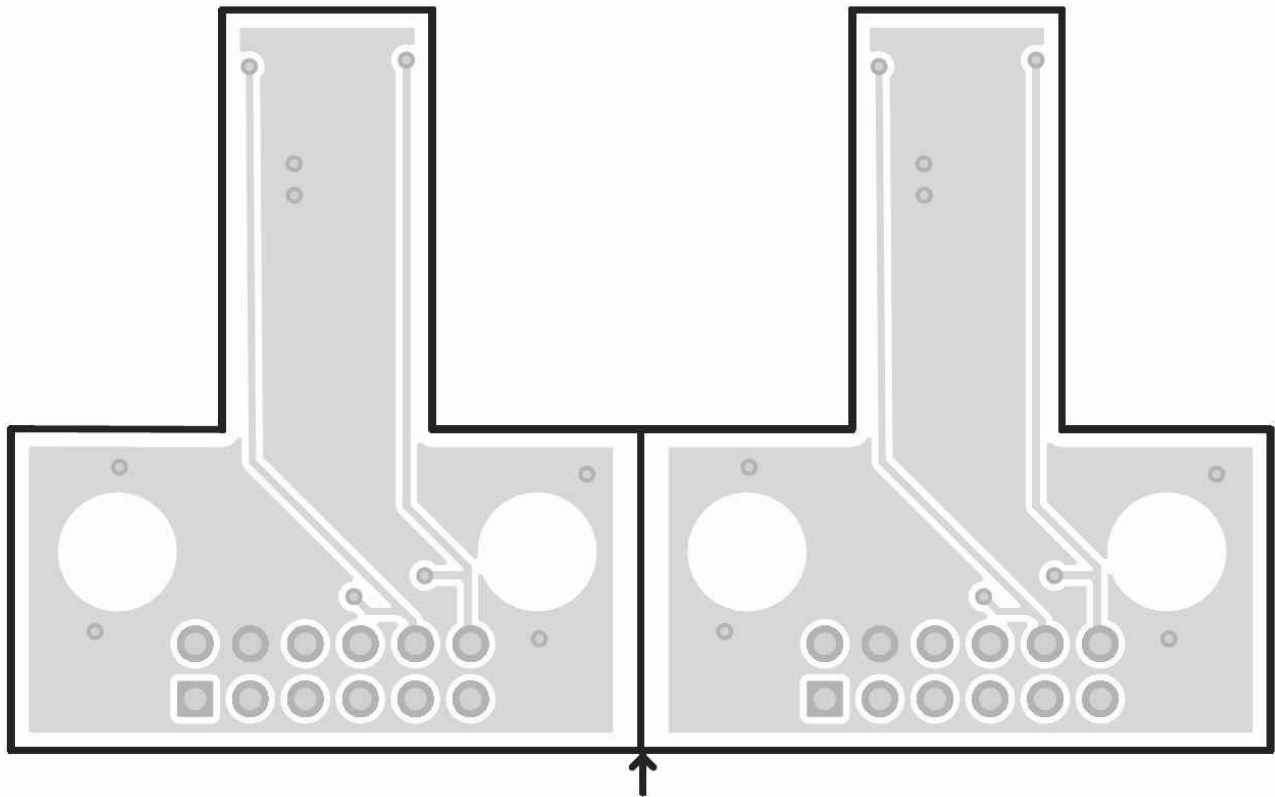


Figure 6-10. TMAG5273EVM Bottom Layer

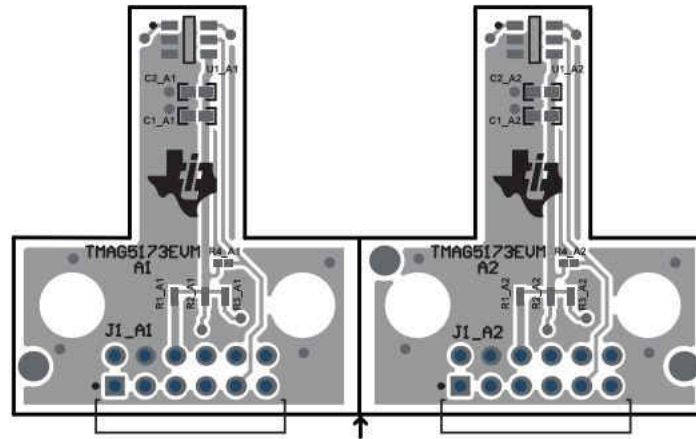


Figure 6-11. TMAP5173EVM Top View

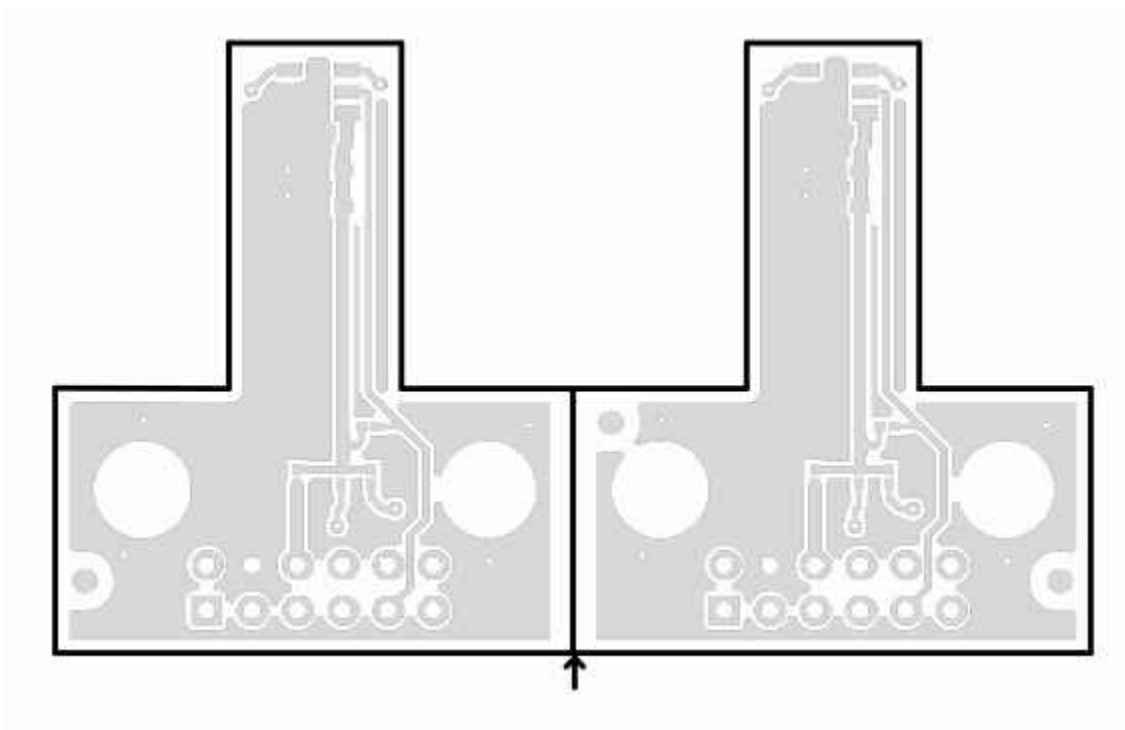


Figure 6-12. TMAP5173EVM Top Layer

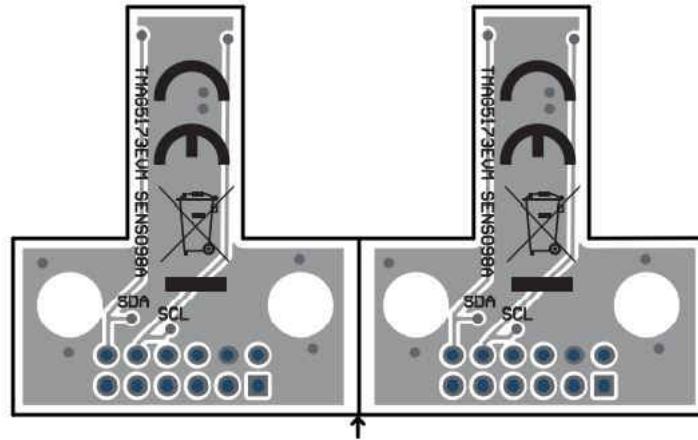


Figure 6-13. TMA5173EVM Bottom View

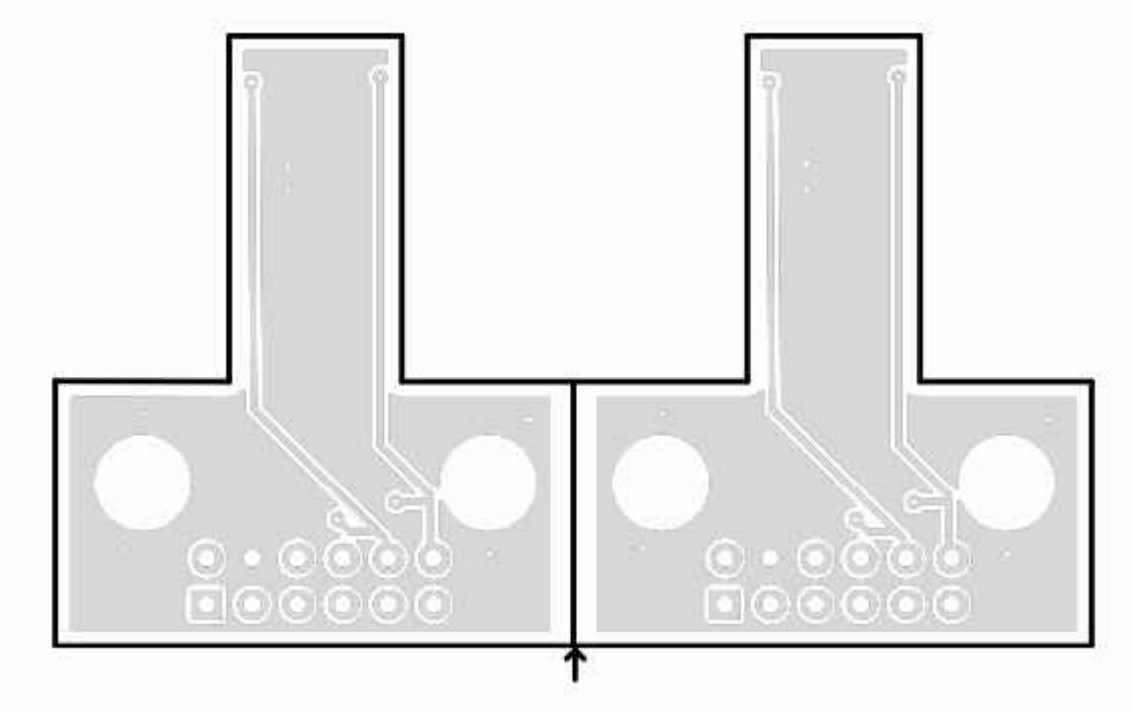


Figure 6-14. TMA5173EVM Bottom Layer

### 6.3 Bill of Materials

Table 6-1 provides the parts list for the TMAG5273 EVM.

**Table 6-1. TMAG5273EVM Bill of Materials**

DESIGNATOR	QUANTITY	VALUE	DESCRIPTION	PACKAGE REFERENCE	PART NUMBER	MANUFACTURER
!PCB	1		Printed Circuit Board		SENS078	Any
C1_A1, C1_A2	2	1uF	CAP, CERM, 1 $\mu$ F, 25 V, +/- 10%, X5R, 0402	0402	GRM155R61E105KA12D	MuRata
C2_A1, C2_A2	2	0.1uF	CAP, CERM, 0.1 $\mu$ F, 50 V, +/- 20%, X7R, 0402	0402	GRM155R71H104ME14D	MuRata
FID1, FID2, FID3	3		Fiducial mark. There is nothing to buy or mount.	N/A	N/A	N/A
J1_A1, J1_A2	2		CONN HEADER R/A 12POS 2MM	HDR12	NRPN062PARN-RC	Sullins Connector Solutions
R1_A1, R1_A2	2	0	RES, 0, 5%, 0.05 W, 0201	0201	CRCW02010000Z0ED	Vishay-Dale
R2_A1, R2_A2, R3_A1, R3_A2, R4_A1, R4_A2	6	4.7k	RES, 4.7k, 5%, 0.05 W, 0201	0201	RC0201JR-7D4K7L	Yageo America
U1_A1	1		3-Axis Linear Hall-Effect Sensor with I2C Interface	SOT23-6	TMAG5273A1QDBVR	Texas Instruments
U1_A2	1		3-Axis Linear Hall Effect Sensor With I2C Interface	SOT-23-6	TMAG5273A2QDBVR	Texas Instruments

Table 6-2 provides the parts list for the TMAG5273 EVM.

**Table 6-2. TMAG5173EVM Bill of Materials**

DESIGNATOR	QUANTITY	VALUE	DESCRIPTION	PACKAGE REFERENCE	PART NUMBER	MANUFACTURER
!PCB1	1		Printed Circuit Board		SENS098	Any
C1_A1, C1_A2	2	1uF	CAP, CERM, 1 uF, 25 V, +/- 10%, X5R, 0402	0402	GRM155R61E105KA12D	MuRata
C2_A1, C2_A2	2	0.1uF	CAP, CERM, 0.1 uF, 50 V, +/- 20%, X7R, 0402	0402	GRM155R71H104ME14D	MuRata
FID1, FID2, FID3	3		Fiducial mark. There is nothing to buy or mount.	N/A	N/A	N/A
J1_A1, J1_A2	2		CONN HEADER R/A 12POS 2MM	HDR12	NRPN062PARN-RC	Sullins Connector Solutions
R1_A1, R2_A2	2	0	RES, 0, 5%, 0.05 W, 0201	0201	CRCW02010000Z0ED	Vishay-Dale
R2_A1, R2_A2, R3_A1, R3_A2, R4_A1, R4_A2	6	4.7k	RES, 4.7 k, 5%, 0.05 W, 0201	0201	RC0201JR-7D4K7L	Yageo America
U1_A1	1		Low-Power Linear 3D Hall-Effect Sensor With I2C Interface	SOT23-6	TMAG5173A1QDBVRQ1	Texas Instruments
U1_A2	1		Low-Power Linear 3D Hall-Effect Sensor With I2C Interface	SOT23-6	TMAG5173A2QDBVRQ1	Texas Instruments

## 7 Revision History

NOTE: Page numbers for previous revisions may differ from page numbers in the current version.

---

### Changes from Revision B (September 2022) to Revision C (September 2022) Page

- Changed GUI download link..... 9
  - Changed the *Bill of Materials* tables..... 28
- 

### Changes from Revision A (September 2021) to Revision B (September 2022) Page

- Added TMAG5173 EVM to the document..... 3
  - Changed [Table 1-2](#) ..... 5
  - Changed [Table 1-3](#) ..... 5
  - Changed [Section 3.1](#) ..... 6
  - Changed [Section 4.1.2](#) ..... 8
  - Changed [Section 4.2](#) ..... 11
  - Changed [Section 4.3](#) ..... 13
  - Changed [Section 4.4](#) ..... 15
- 

### Changes from Revision \* (May 2021) to Revision A (September 2021) Page

- Added [Figure 1-1](#) ..... 3
  - Added [Figure 3-1](#) ..... 6
  - Changed the figures in [Section 4](#) ..... 7
  - Changed [Figure 4-4](#) ..... 9
  - Added [Section 4.2](#) ..... 11
  - Added [Section 4.4](#) ..... 15
  - Changed the figures in [Section 6.1](#) ..... 18
  - Changed the figures in [Section 6.2](#) ..... 24
-

## STANDARD TERMS FOR EVALUATION MODULES

1. *Delivery:* TI delivers TI evaluation boards, kits, or modules, including any accompanying demonstration software, components, and/or documentation which may be provided together or separately (collectively, an "EVM" or "EVMs") to the User ("User") in accordance with the terms set forth herein. User's acceptance of the EVM is expressly subject to the following terms.
  - 1.1 EVMs are intended solely for product or software developers for use in a research and development setting to facilitate feasibility evaluation, experimentation, or scientific analysis of TI semiconductors products. EVMs have no direct function and are not finished products. EVMs shall not be directly or indirectly assembled as a part or subassembly in any finished product. For clarification, any software or software tools provided with the EVM ("Software") shall not be subject to the terms and conditions set forth herein but rather shall be subject to the applicable terms that accompany such Software
  - 1.2 EVMs are not intended for consumer or household use. EVMs may not be sold, sublicensed, leased, rented, loaned, assigned, or otherwise distributed for commercial purposes by Users, in whole or in part, or used in any finished product or production system.
2. *Limited Warranty and Related Remedies/Disclaimers:*
  - 2.1 These terms do not apply to Software. The warranty, if any, for Software is covered in the applicable Software License Agreement.
  - 2.2 TI warrants that the TI EVM will conform to TI's published specifications for ninety (90) days after the date TI delivers such EVM to User. Notwithstanding the foregoing, TI shall not be liable for a nonconforming EVM if (a) the nonconformity was caused by neglect, misuse or mistreatment by an entity other than TI, including improper installation or testing, or for any EVMs that have been altered or modified in any way by an entity other than TI, (b) the nonconformity resulted from User's design, specifications or instructions for such EVMs or improper system design, or (c) User has not paid on time. Testing and other quality control techniques are used to the extent TI deems necessary. TI does not test all parameters of each EVM. User's claims against TI under this Section 2 are void if User fails to notify TI of any apparent defects in the EVMs within ten (10) business days after delivery, or of any hidden defects with ten (10) business days after the defect has been detected.
  - 2.3 TI's sole liability shall be at its option to repair or replace EVMs that fail to conform to the warranty set forth above, or credit User's account for such EVM. TI's liability under this warranty shall be limited to EVMs that are returned during the warranty period to the address designated by TI and that are determined by TI not to conform to such warranty. If TI elects to repair or replace such EVM, TI shall have a reasonable time to repair such EVM or provide replacements. Repaired EVMs shall be warranted for the remainder of the original warranty period. Replaced EVMs shall be warranted for a new full ninety (90) day warranty period.

### **WARNING**

**Evaluation Kits are intended solely for use by technically qualified, professional electronics experts who are familiar with the dangers and application risks associated with handling electrical mechanical components, systems, and subsystems.**

**User shall operate the Evaluation Kit within TI's recommended guidelines and any applicable legal or environmental requirements as well as reasonable and customary safeguards. Failure to set up and/or operate the Evaluation Kit within TI's recommended guidelines may result in personal injury or death or property damage. Proper set up entails following TI's instructions for electrical ratings of interface circuits such as input, output and electrical loads.**

**NOTE:**

**EXPOSURE TO ELECTROSTATIC DISCHARGE (ESD) MAY CAUSE DEGRADATION OR FAILURE OF THE EVALUATION KIT; TI RECOMMENDS STORAGE OF THE EVALUATION KIT IN A PROTECTIVE ESD BAG.**

### 3 Regulatory Notices:

#### 3.1 United States

##### 3.1.1 Notice applicable to EVMs not FCC-Approved:

**FCC NOTICE:** This kit is designed to allow product developers to evaluate electronic components, circuitry, or software associated with the kit to determine whether to incorporate such items in a finished product and software developers to write software applications for use with the end product. This kit is not a finished product and when assembled may not be resold or otherwise marketed unless all required FCC equipment authorizations are first obtained. Operation is subject to the condition that this product not cause harmful interference to licensed radio stations and that this product accept harmful interference. Unless the assembled kit is designed to operate under part 15, part 18 or part 95 of this chapter, the operator of the kit must operate under the authority of an FCC license holder or must secure an experimental authorization under part 5 of this chapter.

##### 3.1.2 For EVMs annotated as FCC – FEDERAL COMMUNICATIONS COMMISSION Part 15 Compliant:

#### **CAUTION**

This device complies with part 15 of the FCC Rules. Operation is subject to the following two conditions: (1) This device may not cause harmful interference, and (2) this device must accept any interference received, including interference that may cause undesired operation.

Changes or modifications not expressly approved by the party responsible for compliance could void the user's authority to operate the equipment.

#### **FCC Interference Statement for Class A EVM devices**

*NOTE: This equipment has been tested and found to comply with the limits for a Class A digital device, pursuant to part 15 of the FCC Rules. These limits are designed to provide reasonable protection against harmful interference when the equipment is operated in a commercial environment. This equipment generates, uses, and can radiate radio frequency energy and, if not installed and used in accordance with the instruction manual, may cause harmful interference to radio communications. Operation of this equipment in a residential area is likely to cause harmful interference in which case the user will be required to correct the interference at his own expense.*

#### **FCC Interference Statement for Class B EVM devices**

*NOTE: This equipment has been tested and found to comply with the limits for a Class B digital device, pursuant to part 15 of the FCC Rules. These limits are designed to provide reasonable protection against harmful interference in a residential installation. This equipment generates, uses and can radiate radio frequency energy and, if not installed and used in accordance with the instructions, may cause harmful interference to radio communications. However, there is no guarantee that interference will not occur in a particular installation. If this equipment does cause harmful interference to radio or television reception, which can be determined by turning the equipment off and on, the user is encouraged to try to correct the interference by one or more of the following measures:*

- Reorient or relocate the receiving antenna.
- Increase the separation between the equipment and receiver.
- Connect the equipment into an outlet on a circuit different from that to which the receiver is connected.
- Consult the dealer or an experienced radio/TV technician for help.

#### 3.2 Canada

##### 3.2.1 For EVMs issued with an Industry Canada Certificate of Conformance to RSS-210 or RSS-247

#### **Concerning EVMs Including Radio Transmitters:**

This device complies with Industry Canada license-exempt RSSs. Operation is subject to the following two conditions:

(1) this device may not cause interference, and (2) this device must accept any interference, including interference that may cause undesired operation of the device.

#### **Concernant les EVMs avec appareils radio:**

Le présent appareil est conforme aux CNR d'Industrie Canada applicables aux appareils radio exempts de licence. L'exploitation est autorisée aux deux conditions suivantes: (1) l'appareil ne doit pas produire de brouillage, et (2) l'utilisateur de l'appareil doit accepter tout brouillage radioélectrique subi, même si le brouillage est susceptible d'en compromettre le fonctionnement.

#### **Concerning EVMs Including Detachable Antennas:**

Under Industry Canada regulations, this radio transmitter may only operate using an antenna of a type and maximum (or lesser) gain approved for the transmitter by Industry Canada. To reduce potential radio interference to other users, the antenna type and its gain should be so chosen that the equivalent isotropically radiated power (e.i.r.p.) is not more than that necessary for successful communication. This radio transmitter has been approved by Industry Canada to operate with the antenna types listed in the user guide with the maximum permissible gain and required antenna impedance for each antenna type indicated. Antenna types not included in this list, having a gain greater than the maximum gain indicated for that type, are strictly prohibited for use with this device.



### Concernant les EVMs avec antennes détachables

Conformément à la réglementation d'Industrie Canada, le présent émetteur radio peut fonctionner avec une antenne d'un type et d'un gain maximal (ou inférieur) approuvé pour l'émetteur par Industrie Canada. Dans le but de réduire les risques de brouillage radioélectrique à l'intention des autres utilisateurs, il faut choisir le type d'antenne et son gain de sorte que la puissance isotrope rayonnée équivalente (p.i.r.e.) ne dépasse pas l'intensité nécessaire à l'établissement d'une communication satisfaisante. Le présent émetteur radio a été approuvé par Industrie Canada pour fonctionner avec les types d'antenne énumérés dans le manuel d'usage et ayant un gain admissible maximal et l'impédance requise pour chaque type d'antenne. Les types d'antenne non inclus dans cette liste, ou dont le gain est supérieur au gain maximal indiqué, sont strictement interdits pour l'exploitation de l'émetteur.

#### 3.3 Japan

3.3.1 *Notice for EVMs delivered in Japan:* Please see [http://www.tij.co.jp/lstds/ti\\_ja/general/eStore/notice\\_01.page](http://www.tij.co.jp/lstds/ti_ja/general/eStore/notice_01.page) 日本国内に輸入される評価用キット、ボードについては、次のところをご覧ください。  
[http://www.tij.co.jp/lstds/ti\\_ja/general/eStore/notice\\_01.page](http://www.tij.co.jp/lstds/ti_ja/general/eStore/notice_01.page)

3.3.2 *Notice for Users of EVMs Considered "Radio Frequency Products" in Japan:* EVMs entering Japan may not be certified by TI as conforming to Technical Regulations of Radio Law of Japan.

If User uses EVMs in Japan, not certified to Technical Regulations of Radio Law of Japan, User is required to follow the instructions set forth by Radio Law of Japan, which includes, but is not limited to, the instructions below with respect to EVMs (which for the avoidance of doubt are stated strictly for convenience and should be verified by User):

1. Use EVMs in a shielded room or any other test facility as defined in the notification #173 issued by Ministry of Internal Affairs and Communications on March 28, 2006, based on Sub-section 1.1 of Article 6 of the Ministry's Rule for Enforcement of Radio Law of Japan,
2. Use EVMs only after User obtains the license of Test Radio Station as provided in Radio Law of Japan with respect to EVMs, or
3. Use of EVMs only after User obtains the Technical Regulations Conformity Certification as provided in Radio Law of Japan with respect to EVMs. Also, do not transfer EVMs, unless User gives the same notice above to the transferee. Please note that if User does not follow the instructions above, User will be subject to penalties of Radio Law of Japan.

【無線電波を送信する製品の開発キットをお使いになる際の注意事項】 開発キットの中には技術基準適合証明を受けていないものがあります。技術適合証明を受けていないものご使用に際しては、電波法遵守のため、以下のいずれかの措置を取っていただく必要がありますのでご注意ください。

1. 電波法施行規則第6条第1項第1号に基づく平成18年3月28日総務省告示第173号で定められた電波暗室等の試験設備でご使用いただく。
2. 実験局の免許を取得後ご使用いただく。
3. 技術基準適合証明を取得後ご使用いただく。

なお、本製品は、上記の「ご使用にあたっての注意」を譲渡先、移転先に通知しない限り、譲渡、移転できないものとします。

上記を遵守頂けない場合は、電波法の罰則が適用される可能性があることをご留意ください。日本テキサス・インスツルメンツ株式会社  
東京都新宿区西新宿 6 丁目 2 4 番 1 号  
西新宿三井ビル

3.3.3 *Notice for EVMs for Power Line Communication:* Please see [http://www.tij.co.jp/lstds/ti\\_ja/general/eStore/notice\\_02.page](http://www.tij.co.jp/lstds/ti_ja/general/eStore/notice_02.page) 電力線搬送波通信についての開発キットをお使いになる際の注意事項については、次のところをご覧ください。  
[http://www.tij.co.jp/lstds/ti\\_ja/general/eStore/notice\\_02.page](http://www.tij.co.jp/lstds/ti_ja/general/eStore/notice_02.page)

#### 3.4 European Union

3.4.1 *For EVMs subject to EU Directive 2014/30/EU (Electromagnetic Compatibility Directive):*

This is a class A product intended for use in environments other than domestic environments that are connected to a low-voltage power-supply network that supplies buildings used for domestic purposes. In a domestic environment this product may cause radio interference in which case the user may be required to take adequate measures.

- 
4. *EVM Use Restrictions and Warnings:*
    - 4.1 EVMS ARE NOT FOR USE IN FUNCTIONAL SAFETY AND/OR SAFETY CRITICAL EVALUATIONS, INCLUDING BUT NOT LIMITED TO EVALUATIONS OF LIFE SUPPORT APPLICATIONS.
    - 4.2 User must read and apply the user guide and other available documentation provided by TI regarding the EVM prior to handling or using the EVM, including without limitation any warning or restriction notices. The notices contain important safety information related to, for example, temperatures and voltages.
    - 4.3 *Safety-Related Warnings and Restrictions:*
      - 4.3.1 User shall operate the EVM within TI's recommended specifications and environmental considerations stated in the user guide, other available documentation provided by TI, and any other applicable requirements and employ reasonable and customary safeguards. Exceeding the specified performance ratings and specifications (including but not limited to input and output voltage, current, power, and environmental ranges) for the EVM may cause personal injury or death, or property damage. If there are questions concerning performance ratings and specifications, User should contact a TI field representative prior to connecting interface electronics including input power and intended loads. Any loads applied outside of the specified output range may also result in unintended and/or inaccurate operation and/or possible permanent damage to the EVM and/or interface electronics. Please consult the EVM user guide prior to connecting any load to the EVM output. If there is uncertainty as to the load specification, please contact a TI field representative. During normal operation, even with the inputs and outputs kept within the specified allowable ranges, some circuit components may have elevated case temperatures. These components include but are not limited to linear regulators, switching transistors, pass transistors, current sense resistors, and heat sinks, which can be identified using the information in the associated documentation. When working with the EVM, please be aware that the EVM may become very warm.
      - 4.3.2 EVMs are intended solely for use by technically qualified, professional electronics experts who are familiar with the dangers and application risks associated with handling electrical mechanical components, systems, and subsystems. User assumes all responsibility and liability for proper and safe handling and use of the EVM by User or its employees, affiliates, contractors or designees. User assumes all responsibility and liability to ensure that any interfaces (electronic and/or mechanical) between the EVM and any human body are designed with suitable isolation and means to safely limit accessible leakage currents to minimize the risk of electrical shock hazard. User assumes all responsibility and liability for any improper or unsafe handling or use of the EVM by User or its employees, affiliates, contractors or designees.
    - 4.4 User assumes all responsibility and liability to determine whether the EVM is subject to any applicable international, federal, state, or local laws and regulations related to User's handling and use of the EVM and, if applicable, User assumes all responsibility and liability for compliance in all respects with such laws and regulations. User assumes all responsibility and liability for proper disposal and recycling of the EVM consistent with all applicable international, federal, state, and local requirements.
  5. *Accuracy of Information:* To the extent TI provides information on the availability and function of EVMs, TI attempts to be as accurate as possible. However, TI does not warrant the accuracy of EVM descriptions, EVM availability or other information on its websites as accurate, complete, reliable, current, or error-free.
  6. *Disclaimers:*
    - 6.1 EXCEPT AS SET FORTH ABOVE, EVMS AND ANY MATERIALS PROVIDED WITH THE EVM (INCLUDING, BUT NOT LIMITED TO, REFERENCE DESIGNS AND THE DESIGN OF THE EVM ITSELF) ARE PROVIDED "AS IS" AND "WITH ALL FAULTS." TI DISCLAIMS ALL OTHER WARRANTIES, EXPRESS OR IMPLIED, REGARDING SUCH ITEMS, INCLUDING BUT NOT LIMITED TO ANY EPIDEMIC FAILURE WARRANTY OR IMPLIED WARRANTIES OF MERCHANTABILITY OR FITNESS FOR A PARTICULAR PURPOSE OR NON-INFRINGEMENT OF ANY THIRD PARTY PATENTS, COPYRIGHTS, TRADE SECRETS OR OTHER INTELLECTUAL PROPERTY RIGHTS.
    - 6.2 EXCEPT FOR THE LIMITED RIGHT TO USE THE EVM SET FORTH HEREIN, NOTHING IN THESE TERMS SHALL BE CONSTRUED AS GRANTING OR CONFERRING ANY RIGHTS BY LICENSE, PATENT, OR ANY OTHER INDUSTRIAL OR INTELLECTUAL PROPERTY RIGHT OF TI, ITS SUPPLIERS/LICENSORS OR ANY OTHER THIRD PARTY, TO USE THE EVM IN ANY FINISHED END-USER OR READY-TO-USE FINAL PRODUCT, OR FOR ANY INVENTION, DISCOVERY OR IMPROVEMENT, REGARDLESS OF WHEN MADE, CONCEIVED OR ACQUIRED.
  7. *USER'S INDEMNITY OBLIGATIONS AND REPRESENTATIONS.* USER WILL DEFEND, INDEMNIFY AND HOLD TI, ITS LICENSORS AND THEIR REPRESENTATIVES HARMLESS FROM AND AGAINST ANY AND ALL CLAIMS, DAMAGES, LOSSES, EXPENSES, COSTS AND LIABILITIES (COLLECTIVELY, "CLAIMS") ARISING OUT OF OR IN CONNECTION WITH ANY HANDLING OR USE OF THE EVM THAT IS NOT IN ACCORDANCE WITH THESE TERMS. THIS OBLIGATION SHALL APPLY WHETHER CLAIMS ARISE UNDER STATUTE, REGULATION, OR THE LAW OF TORT, CONTRACT OR ANY OTHER LEGAL THEORY, AND EVEN IF THE EVM FAILS TO PERFORM AS DESCRIBED OR EXPECTED.

8. *Limitations on Damages and Liability:*

8.1 *General Limitations.* IN NO EVENT SHALL TI BE LIABLE FOR ANY SPECIAL, COLLATERAL, INDIRECT, PUNITIVE, INCIDENTAL, CONSEQUENTIAL, OR EXEMPLARY DAMAGES IN CONNECTION WITH OR ARISING OUT OF THESE TERMS OR THE USE OF THE EVMS , REGARDLESS OF WHETHER TI HAS BEEN ADVISED OF THE POSSIBILITY OF SUCH DAMAGES. EXCLUDED DAMAGES INCLUDE, BUT ARE NOT LIMITED TO, COST OF REMOVAL OR REINSTALLATION, ANCILLARY COSTS TO THE PROCUREMENT OF SUBSTITUTE GOODS OR SERVICES, RETESTING, OUTSIDE COMPUTER TIME, LABOR COSTS, LOSS OF GOODWILL, LOSS OF PROFITS, LOSS OF SAVINGS, LOSS OF USE, LOSS OF DATA, OR BUSINESS INTERRUPTION. NO CLAIM, SUIT OR ACTION SHALL BE BROUGHT AGAINST TI MORE THAN TWELVE (12) MONTHS AFTER THE EVENT THAT GAVE RISE TO THE CAUSE OF ACTION HAS OCCURRED.

8.2 *Specific Limitations.* IN NO EVENT SHALL TI'S AGGREGATE LIABILITY FROM ANY USE OF AN EVM PROVIDED HEREUNDER, INCLUDING FROM ANY WARRANTY, INDEMNITY OR OTHER OBLIGATION ARISING OUT OF OR IN CONNECTION WITH THESE TERMS, , EXCEED THE TOTAL AMOUNT PAID TO TI BY USER FOR THE PARTICULAR EVM(S) AT ISSUE DURING THE PRIOR TWELVE (12) MONTHS WITH RESPECT TO WHICH LOSSES OR DAMAGES ARE CLAIMED. THE EXISTENCE OF MORE THAN ONE CLAIM SHALL NOT ENLARGE OR EXTEND THIS LIMIT.

9. *Return Policy.* Except as otherwise provided, TI does not offer any refunds, returns, or exchanges. Furthermore, no return of EVM(s) will be accepted if the package has been opened and no return of the EVM(s) will be accepted if they are damaged or otherwise not in a resalable condition. If User feels it has been incorrectly charged for the EVM(s) it ordered or that delivery violates the applicable order, User should contact TI. All refunds will be made in full within thirty (30) working days from the return of the components(s), excluding any postage or packaging costs.

10. *Governing Law:* These terms and conditions shall be governed by and interpreted in accordance with the laws of the State of Texas, without reference to conflict-of-laws principles. User agrees that non-exclusive jurisdiction for any dispute arising out of or relating to these terms and conditions lies within courts located in the State of Texas and consents to venue in Dallas County, Texas. Notwithstanding the foregoing, any judgment may be enforced in any United States or foreign court, and TI may seek injunctive relief in any United States or foreign court.

Mailing Address: Texas Instruments, Post Office Box 655303, Dallas, Texas 75265  
Copyright © 2019, Texas Instruments Incorporated

## **IMPORTANT NOTICE AND DISCLAIMER**

TI PROVIDES TECHNICAL AND RELIABILITY DATA (INCLUDING DATA SHEETS), DESIGN RESOURCES (INCLUDING REFERENCE DESIGNS), APPLICATION OR OTHER DESIGN ADVICE, WEB TOOLS, SAFETY INFORMATION, AND OTHER RESOURCES "AS IS" AND WITH ALL FAULTS, AND DISCLAIMS ALL WARRANTIES, EXPRESS AND IMPLIED, INCLUDING WITHOUT LIMITATION ANY IMPLIED WARRANTIES OF MERCHANTABILITY, FITNESS FOR A PARTICULAR PURPOSE OR NON-INFRINGEMENT OF THIRD PARTY INTELLECTUAL PROPERTY RIGHTS.

These resources are intended for skilled developers designing with TI products. You are solely responsible for (1) selecting the appropriate TI products for your application, (2) designing, validating and testing your application, and (3) ensuring your application meets applicable standards, and any other safety, security, regulatory or other requirements.

These resources are subject to change without notice. TI grants you permission to use these resources only for development of an application that uses the TI products described in the resource. Other reproduction and display of these resources is prohibited. No license is granted to any other TI intellectual property right or to any third party intellectual property right. TI disclaims responsibility for, and you will fully indemnify TI and its representatives against, any claims, damages, costs, losses, and liabilities arising out of your use of these resources.

TI's products are provided subject to [TI's Terms of Sale](#) or other applicable terms available either on [ti.com](http://ti.com) or provided in conjunction with such TI products. TI's provision of these resources does not expand or otherwise alter TI's applicable warranties or warranty disclaimers for TI products.

TI objects to and rejects any additional or different terms you may have proposed.

Mailing Address: Texas Instruments, Post Office Box 655303, Dallas, Texas 75265  
Copyright © 2022, Texas Instruments Incorporated