

## High Speed Infrared Emitting Diode, 850 nm, GaAlAs, DH

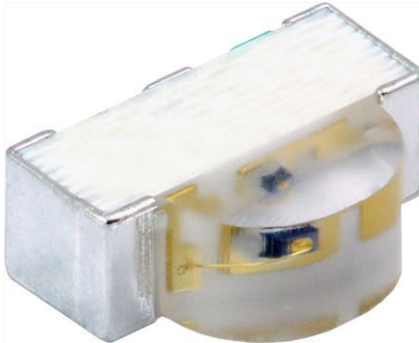

### DESCRIPTION

VSMG10850 is an infrared, 850 nm side looking emitting diode in GaAlAs double hetero (DH) technology with high radiant power and high speed, molded in clear, untinted plastic package for surface mounting (SMD).

### FEATURES

- Package type: Surface mount
- Package form: Side view
- Dimensions (L x W x H in mm): 3 x 2 x 1
- Peak wavelength:  $\lambda_p = 850$  nm
- High reliability
- High radiant power
- High radiant intensity
- High speed
- Angle of half sensitivity:  $\phi = \pm 75^\circ$
- Low forward voltage
- Package matches with detector VEMD10940F
- Floor life: 168 h, MSL 3, according to J-STD-020
- Lead (Pb)-free reflow soldering
- Material categorization: For definitions of compliance please see [www.vishay.com/doc?99912](http://www.vishay.com/doc?99912)



### APPLICATIONS

- IR touch panel
- High power emitter for low space applications
- High performance transmissive or reflective sensors

PRODUCT SUMMARY				
COMPONENT	$I_e$ (mW/sr), 20 mA	$\phi$ (deg)	$\lambda_p$ (nm)	$t_r$ (ns)
VSMG10850	1	$\pm 75$	850	15

#### Note

- Test conditions see table "Basic Characteristics"

ORDERING INFORMATION			
ORDERING CODE	PACKAGING	REMARKS	PACKAGE FORM
VSMG10850	Tape and reel	MOQ: 3000 pcs, 3000 pcs/reel	side view

#### Note

- MOQ: minimum order quantity

ABSOLUTE MAXIMUM RATINGS ( $T_{amb} = 25^\circ\text{C}$ , unless otherwise specified)				
PARAMETER	TEST CONDITION	SYMBOL	VALUE	UNIT
Reverse voltage		$V_R$	5	V
Forward current		$I_F$	65	mA
Peak forward current	$t_p/T = 0.5$ , $t_p = 100 \mu\text{s}$	$I_{FM}$	130	mA
Surge forward current	$t_p = 100 \mu\text{s}$	$I_{FSM}$	500	mA
Power dissipation		$P_V$	110	mW
Junction temperature		$T_j$	100	$^\circ\text{C}$
Operating temperature range		$T_{amb}$	- 40 to + 85	$^\circ\text{C}$
Storage temperature range		$T_{stg}$	- 40 to + 100	$^\circ\text{C}$
Soldering temperature	according to fig. 9, J-STD-020	$T_{sd}$	260	$^\circ\text{C}$
Thermal resistance junction/ambient	J-STD-051, leads 7 mm, soldered on PCB	$R_{thJA}$	450	K/W

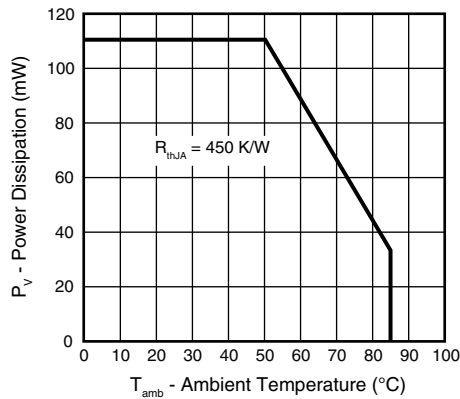

Fig. 1 - Power Dissipation Limit vs. Ambient Temperature

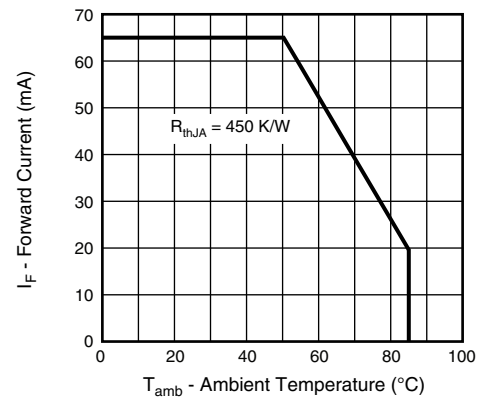

Fig. 2 - Forward Current Limit vs. Ambient Temperature

<b>BASIC CHARACTERISTICS</b> (T <sub>amb</sub> = 25 °C, unless otherwise specified)						
PARAMETER	TEST CONDITION	SYMBOL	MIN.	TYP.	MAX.	UNIT
Forward voltage	I <sub>F</sub> = 20 mA, t <sub>p</sub> = 20 ms	V <sub>F</sub>	1.1	1.4	1.65	V
	I <sub>F</sub> = 65 mA, t <sub>p</sub> = 20 ms	V <sub>F</sub>		1.45		V
	I <sub>F</sub> = 500 mA, t <sub>p</sub> = 100 μs	V <sub>F</sub>		1.9		V
Temperature coefficient of V <sub>F</sub>	I <sub>F</sub> = 1 mA	TK <sub>V<sub>F</sub></sub>		- 1.8		mV/K
Reverse current	V <sub>R</sub> = 5 V	I <sub>R</sub>			10	μA
Junction capacitance	V <sub>R</sub> = 0 V, f = 1 MHz, E = 0 mW/cm <sup>2</sup>	C <sub>J</sub>		45		pF
Radiant intensity	I <sub>F</sub> = 20 mA, t <sub>p</sub> = 20 ms	I <sub>e</sub>	0.6	1	1.8	mW/sr
	I <sub>F</sub> = 65 mA, t <sub>p</sub> = 20 ms	I <sub>e</sub>		3.25		mW/sr
	I <sub>F</sub> = 500 mA, t <sub>p</sub> = 100 μs	I <sub>e</sub>		24		mW/sr
Radiant power	I <sub>F</sub> = 100 mA, t <sub>p</sub> = 20 ms	φ <sub>e</sub>		40		mW
Temperature coefficient of radiant power	I <sub>F</sub> = 1 mA	TK <sub>φ<sub>e</sub></sub>		- 1.1		%/K
Angle of half intensity - horizontal		φ <sub>h</sub>		± 77.5		deg
Angle of half intensity - vertical		φ <sub>v</sub>		± 72.5		deg
Peak wavelength	I <sub>F</sub> = 30 mA	λ <sub>p</sub>		850		nm
Spectral bandwidth	I <sub>F</sub> = 30 mA	Δλ		40		nm
Temperature coefficient of λ <sub>p</sub>	I <sub>F</sub> = 30 mA	TK <sub>λ<sub>p</sub></sub>		0.25		nm
Rise time	I <sub>F</sub> = 100 mA, 20 % to 80 %	t <sub>r</sub>		20		ns
Fall time	I <sub>F</sub> = 100 mA, 20 % to 80 %	t <sub>f</sub>		20		ns

**BASIC CHARACTERISTICS** ( $T_{amb} = 25\text{ }^{\circ}\text{C}$ , unless otherwise specified)

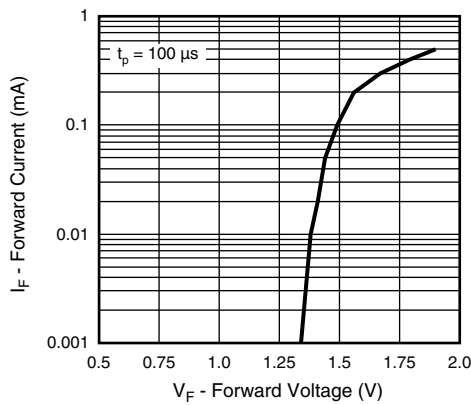

Fig. 3 - Forward Current vs. Forward Voltage

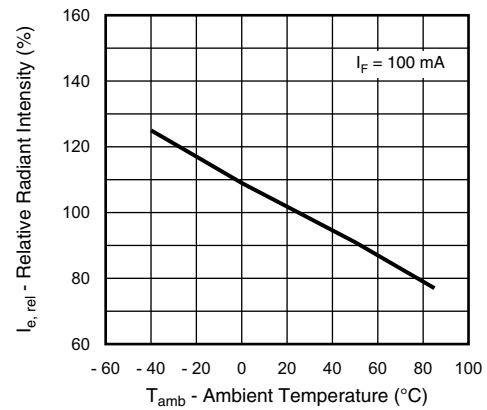

Fig. 6 - Relative Radiant Intensity vs. Ambient Temperature

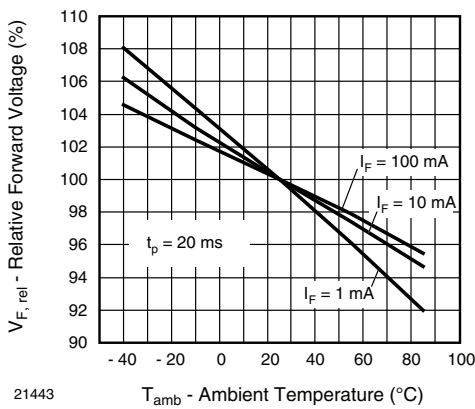

Fig. 4 - Relative Forward Voltage vs. Ambient Temperature

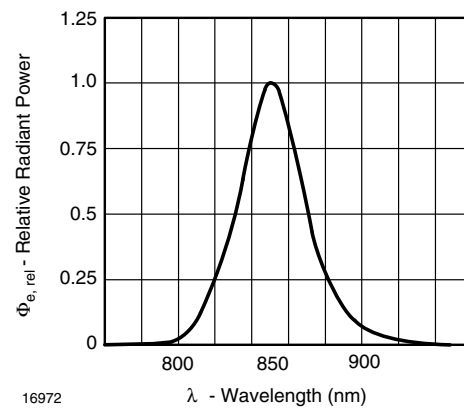

Fig. 7 - Relative Radiant Power vs. Wavelength

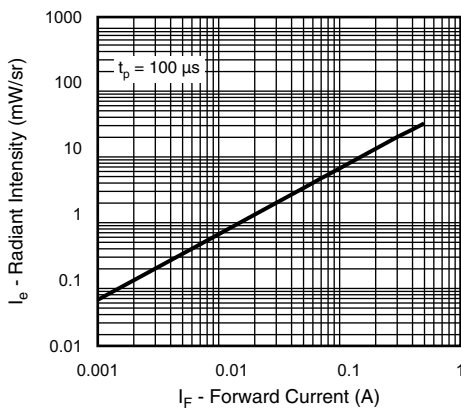

Fig. 5 - Radiant Intensity vs. Forward Current

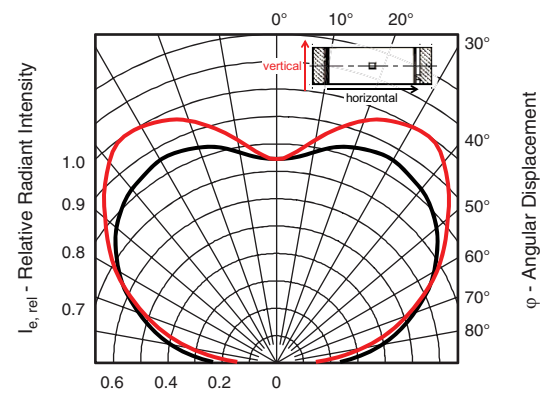

Fig. 8 - Relative Radiant Intensity vs. Angular Displacement

**REFLOW SOLDER PROFILE**

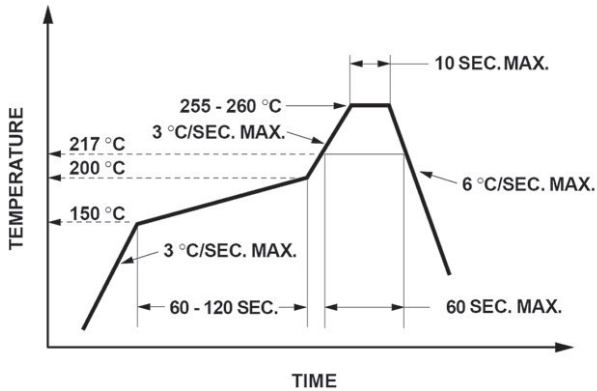

Fig. 9 - Lead (Pb)-free Reflow Solder Profile acc. J-STD-020

**DRYPACK**

Devices are packed in moisture barrier bags (MBB) to prevent the products from moisture absorption during transportation and storage. Each bag contains a desiccant.

**FLOOR LIFE**

Time between soldering and removing from MBB must not exceed the time indicated in J-STD-020:

Moisture sensitivity: level 3

Floor life: 168 h

Conditions:  $T_{amb} < 30\text{ }^{\circ}\text{C}$ , RH < 60 %

**DRYING**

In case of moisture absorption devices should be baked before soldering. Conditions see J-STD-020 or label. Devices taped on reel dry using recommended conditions 192 h at 40 °C (+ 5 °C), RH < 5 %.

**PACKAGE DIMENSIONS** in millimeters

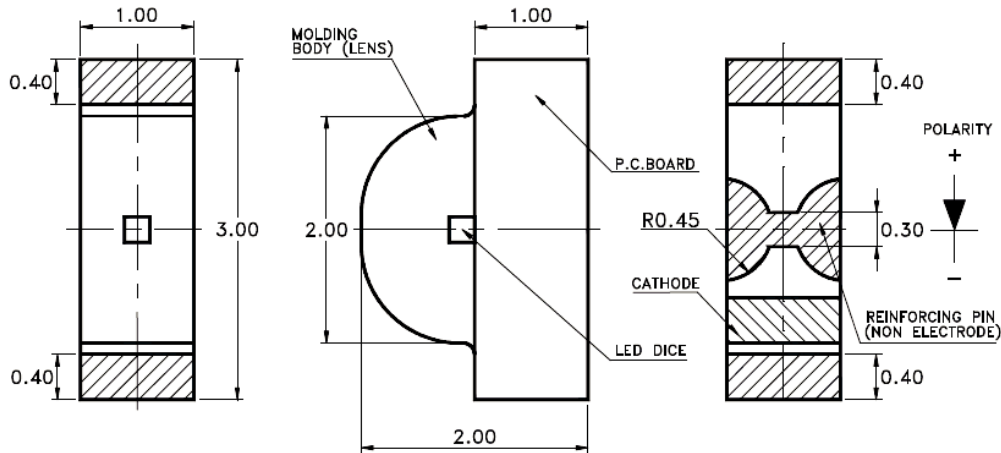

**Recommended Solder Pad Footprint**

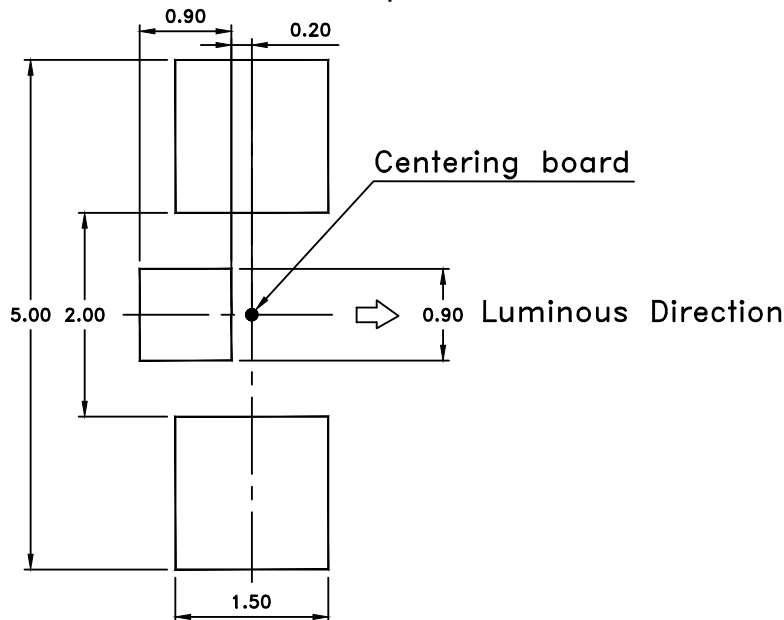

22701



**BLISTER TAPE DIMENSIONS** in millimeters

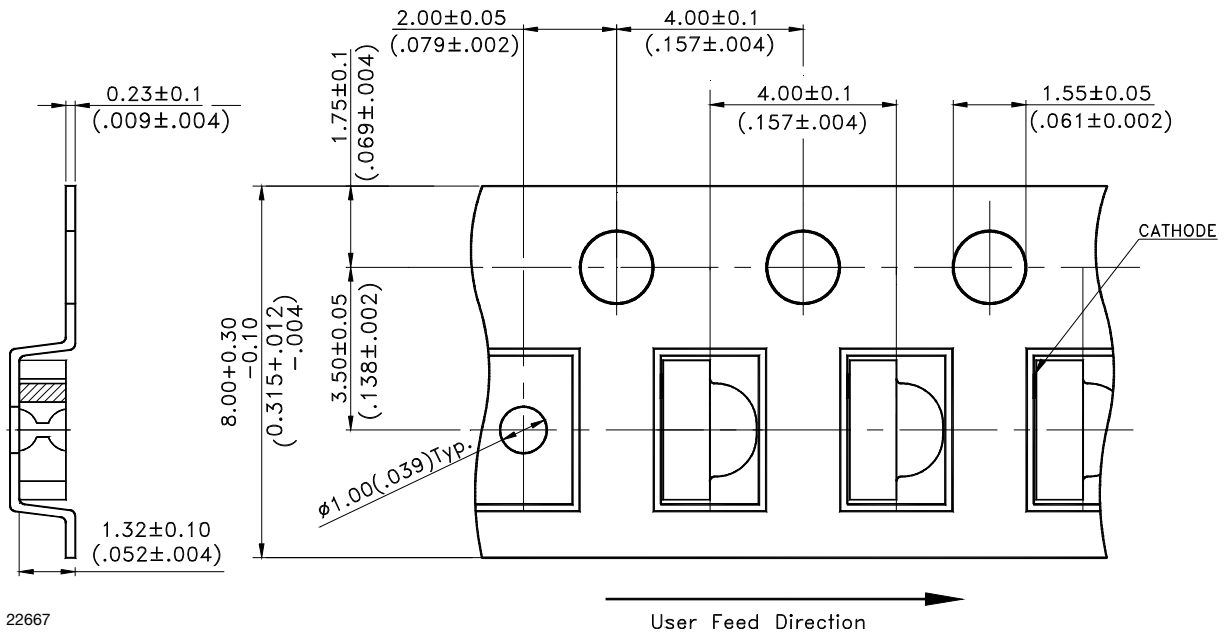

22667

**REEL DIMENSIONS** in millimeters

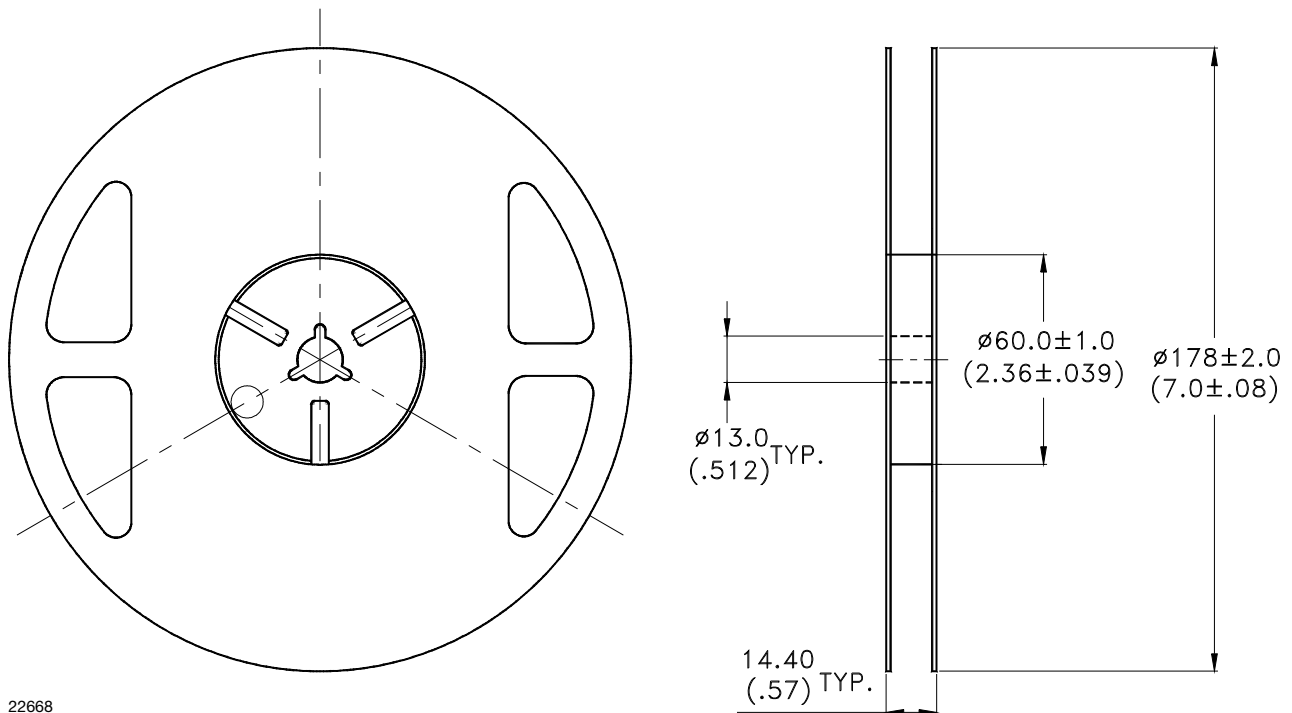

22668



## **Disclaimer**

ALL PRODUCT, PRODUCT SPECIFICATIONS AND DATA ARE SUBJECT TO CHANGE WITHOUT NOTICE TO IMPROVE RELIABILITY, FUNCTION OR DESIGN OR OTHERWISE.

Vishay Intertechnology, Inc., its affiliates, agents, and employees, and all persons acting on its or their behalf (collectively, "Vishay"), disclaim any and all liability for any errors, inaccuracies or incompleteness contained in any datasheet or in any other disclosure relating to any product.

Vishay makes no warranty, representation or guarantee regarding the suitability of the products for any particular purpose or the continuing production of any product. To the maximum extent permitted by applicable law, Vishay disclaims (i) any and all liability arising out of the application or use of any product, (ii) any and all liability, including without limitation special, consequential or incidental damages, and (iii) any and all implied warranties, including warranties of fitness for particular purpose, non-infringement and merchantability.

Statements regarding the suitability of products for certain types of applications are based on Vishay's knowledge of typical requirements that are often placed on Vishay products in generic applications. Such statements are not binding statements about the suitability of products for a particular application. It is the customer's responsibility to validate that a particular product with the properties described in the product specification is suitable for use in a particular application. Parameters provided in datasheets and / or specifications may vary in different applications and performance may vary over time. All operating parameters, including typical parameters, must be validated for each customer application by the customer's technical experts. Product specifications do not expand or otherwise modify Vishay's terms and conditions of purchase, including but not limited to the warranty expressed therein.

Except as expressly indicated in writing, Vishay products are not designed for use in medical, life-saving, or life-sustaining applications or for any other application in which the failure of the Vishay product could result in personal injury or death. Customers using or selling Vishay products not expressly indicated for use in such applications do so at their own risk. Please contact authorized Vishay personnel to obtain written terms and conditions regarding products designed for such applications.

No license, express or implied, by estoppel or otherwise, to any intellectual property rights is granted by this document or by any conduct of Vishay. Product names and markings noted herein may be trademarks of their respective owners.