

**NOTES:**

1. MATERIAL:  
HOUSING: NYLON, GLASS-FILLED, UL94V-0,  
COLOR: BLACK  
PIN: 0.50mm SQ. COPPER ALLOY
2. PLATING FINISH:
  - 1) 15µin MIN. GOLD PLATE IN SELECTED AREA AND 80µin MIN. TIN ON SOLDER TAIL OVER 50µin MIN. NICKEL UNDERPLATE OVERALL.
  - 2) 30µin MIN. GOLD PLATE IN SELECTED AREA AND 80µin MIN. TIN ON SOLDER TAIL OVER 50µin MIN. NICKEL UNDERPLATE OVERALL.
  - 3) 100µin MIN. TIN OVERALL 50µin MIN. NICKEL UNDERPLATE OVERALL.
  - 4) 2-10µin MIN. GOLD OVER 50µin MIN. NICKEL UNDERPLATE OVERALL.
3. PACKAGING: SEE TABLE
4. RECOMMENDED PCB THICKNESS: 1.60±0.10mm
5. PRODUCT SPECIFICATION: PS-87761-100
6. WAFER TO BE FLAT WITHIN 0.003mm/mm
7. BEND DEPRESSION IS ACCEPTED SO LONG AS IT DOES NOT AFFECT THE OVERALL COPLANARITY OF TAIL
8. COPLANARITY IS TO BE MEASURED BY RESTING THE SOLDER TAIL ON A FLAT SURFACE
9. CAP LOCATION IS CENTERED ALONG THE MATING ENDS AS SHOWN. TOP SURFACE OF CAP TO BE FLAT FOR THE PURPOSE OF PICK & PLACE BY VACUUM SUCTION NOZZLE
10. CKT 4 & 6 IS CUT FROM CKT 8 & 12 RESPECTIVELY. ROUGH EDGES ARE EXPECTED ALONG THE CUTTING EDGES
11. THE ABOVE 8CKTS SHOWN IS FOR ILLUSTRATION ONLY.
12. TUBE LENGTH : 560mm REF.

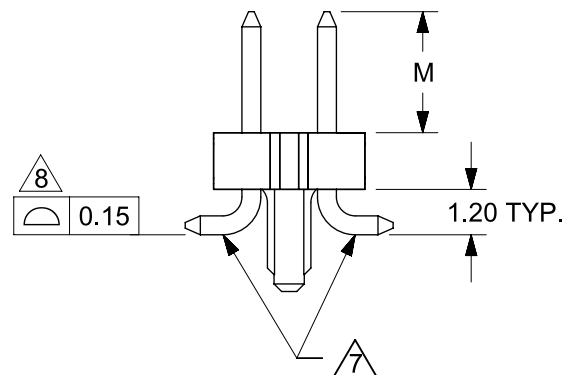
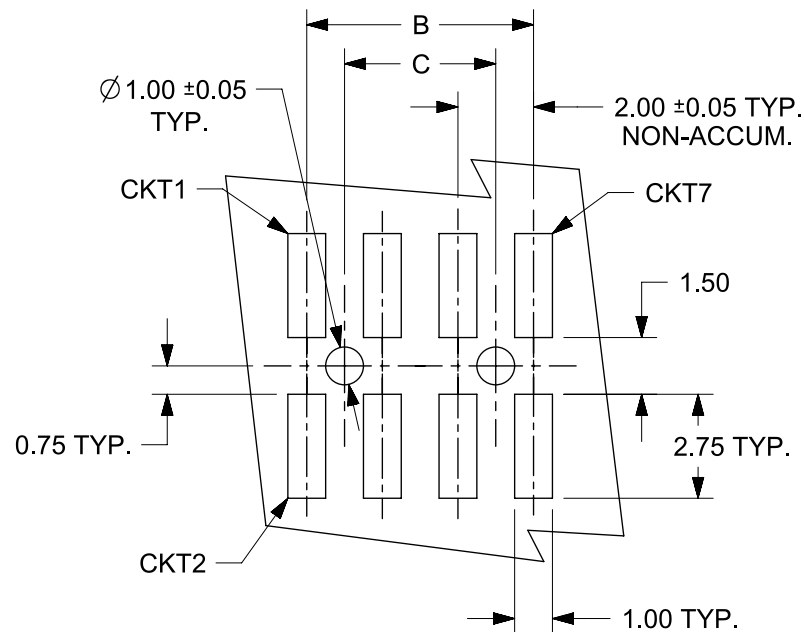
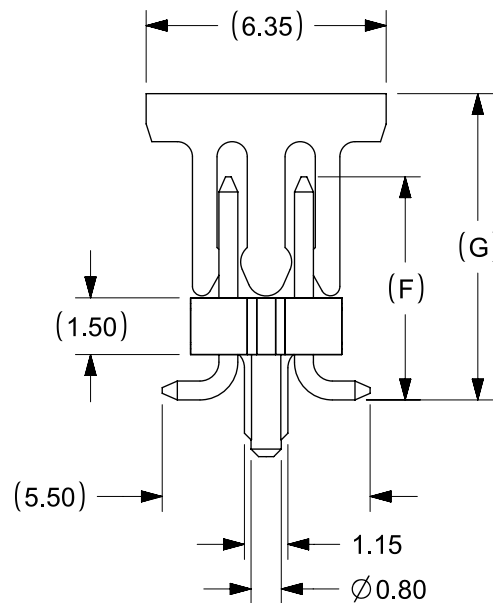
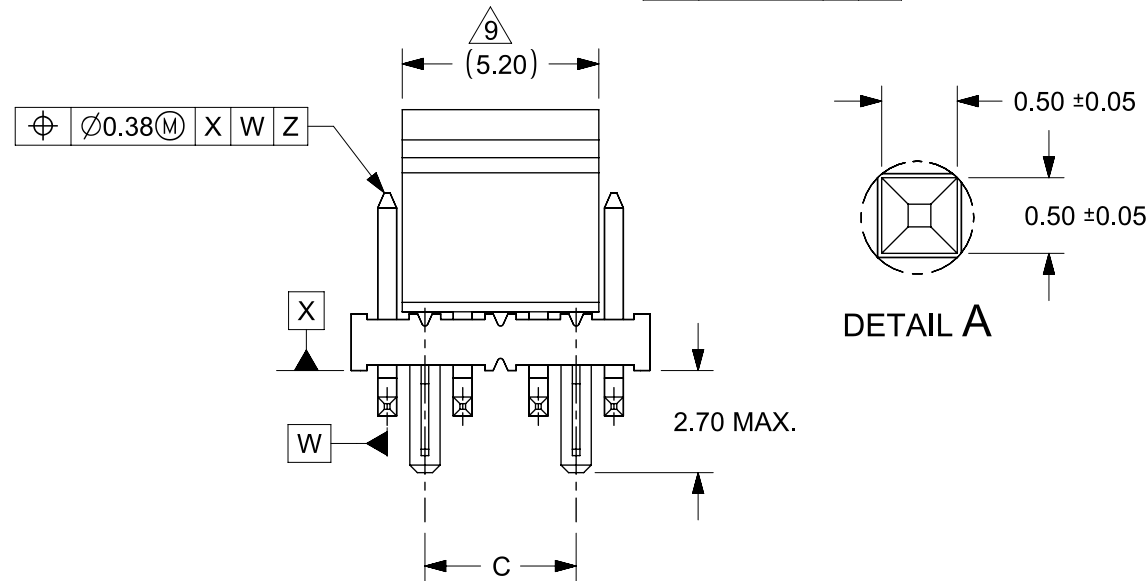

THIS DRAWING CONTAINS INFORMATION THAT IS PROPRIETARY TO MOLEX ELECTRONIC TECHNOLOGIES, LLC AND SHOULD NOT BE USED WITHOUT WRITTEN PERMISSION											
DIMENSION UNITS		SCALE		CURRENT REV DESC:							
mm		NTS									
GENERAL TOLERANCES (UNLESS SPECIFIED)										CUSTOM HEADER	
										2.00MM PITCH DUAL ROW HDR, SINGLE WAFER, SMT	
										PRODUCT CUSTOMER DRAWING	
4 PLACES ±										DOCUMENT NUMBER	
3 PLACES ±										DOC TYPE DOC PART REVISION	
2 PLACES ± 0.2										SD-87759-277 PSD 001 B5	
1 PLACE ±											
0 PLACES ±											
ANGULAR TOL ± 3.0°											
DRAFT WHERE APPLICABLE MUST REMAIN WITHIN DIMENSIONS				THIRD ANGLE PROJECTION		DRAWING		SERIES		SHEET NUMBER	
						A3-SIZE		87759		1 OF 12	

CIRCUITS POSITION CONFIGURATION

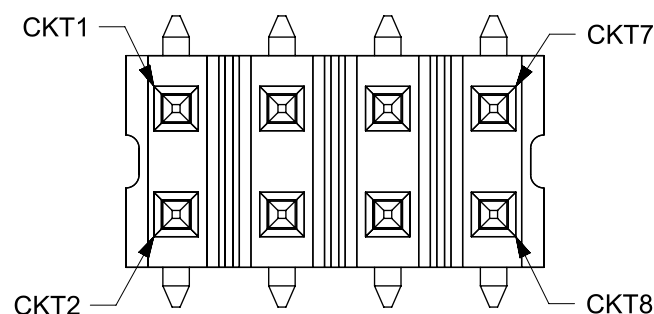

PARTS PACK IN TUBE ORIENTATION

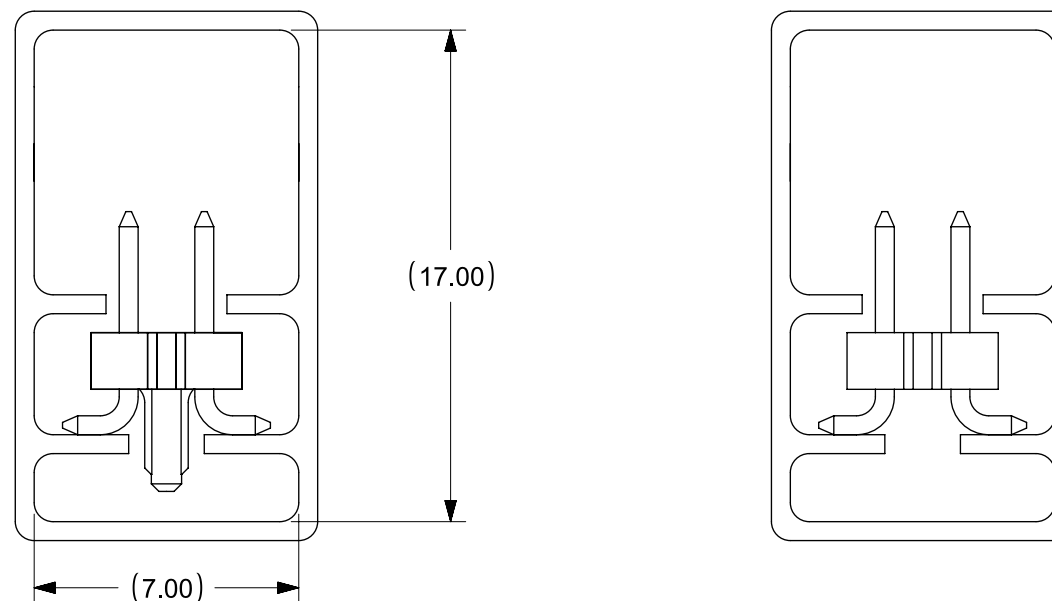

PART WITHOUT CAP IN TUBE  
(PLS REFER TO PK SPEC: PK-89990-475)

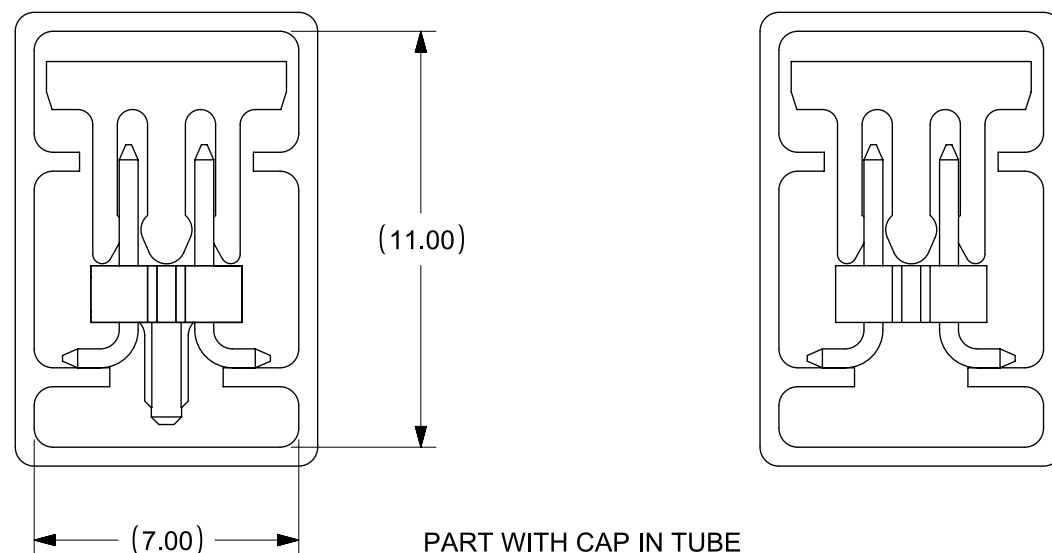

PART WITH CAP IN TUBE  
(PLS REFER TO PK SPEC: PK-89990-476)

THIS DRAWING CONTAINS INFORMATION THAT IS PROPRIETARY TO MOLEX ELECTRONIC TECHNOLOGIES, LLC AND SHOULD NOT BE USED WITHOUT WRITTEN PERMISSION											
DIMENSION UNITS		SCALE		CURRENT REV DESC:							
mm		NTS									
GENERAL TOLERANCES (UNLESS SPECIFIED)										CUSTOM HEADER	
										2.00MM PITCH DUAL ROW HDR, SINGLE WAFER, SMT	
										PRODUCT CUSTOMER DRAWING	
										DOCUMENT NUMBER	
										SD-87759-277	
										DOC TYPE	
										PSD	
										DOC PART	
										001	
										REVISION	
										B5	
										SHEET NUMBER	
										2 OF 12	

WITH CAP IN TAPE & REEL PACKAGING  
 THE 8CKTS SHOWN AS ABOVE IS FOR  
 ILLUSTRATION PURPOSE ONLY.  
 (THIS TYPE E/TAPE USED FOR CKT 8 TO 14)  
 (PLS REFER TO PK SPEC: PK-89990-484)

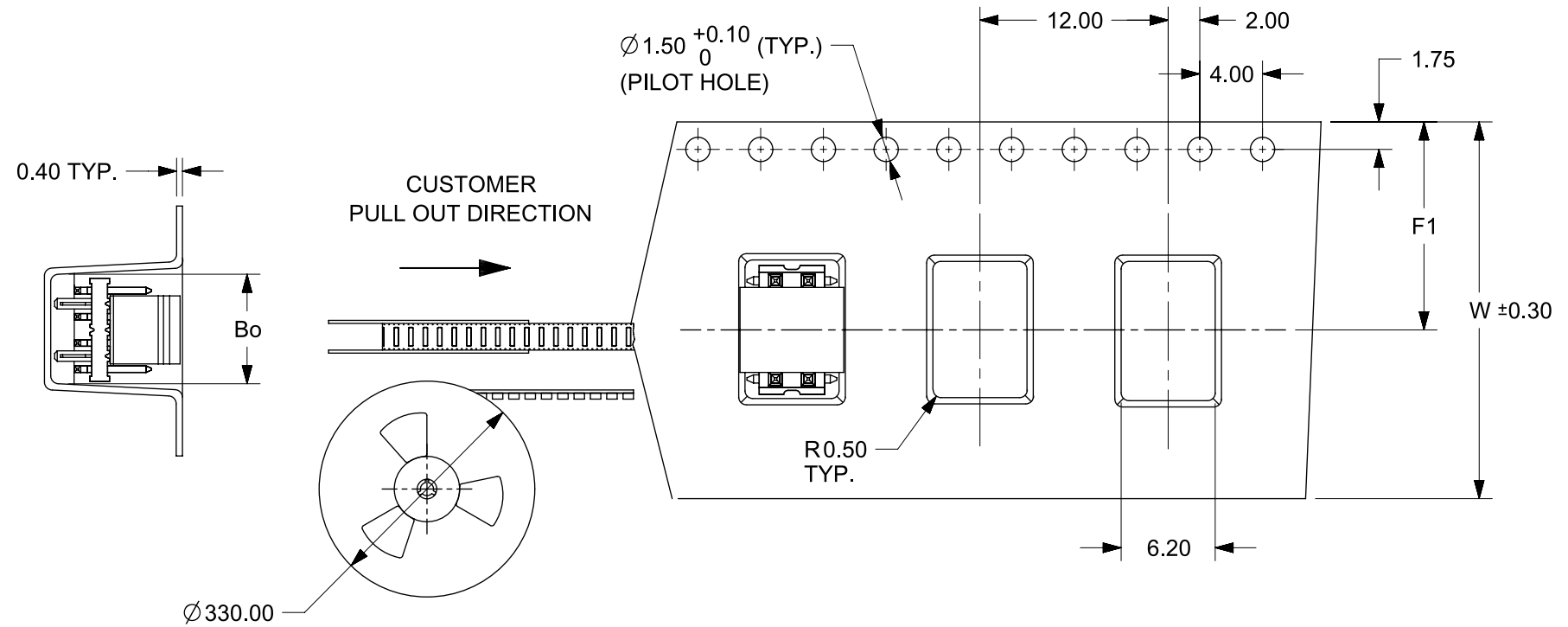

**EMBOSSSED CARRIER TAPE TYPE "A"**

**NOTES:**

**1. LEADER AND TRAILER TAPE**

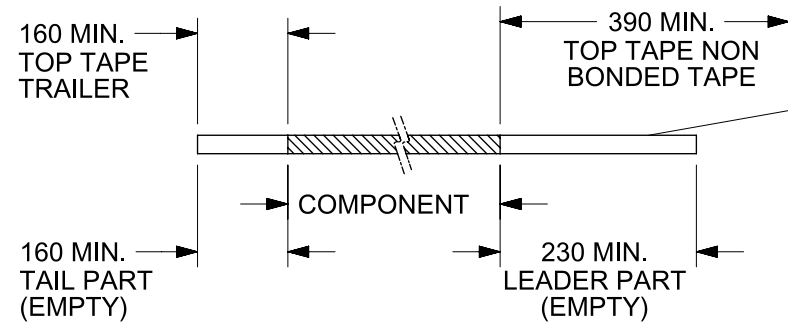

**2. PEELING OFF FORCE OF THE TOP TAPE: 20 - 80gf.  
 (PEELING DIRECTION AS SHOWN IN FOLLOWING FIGURE)**

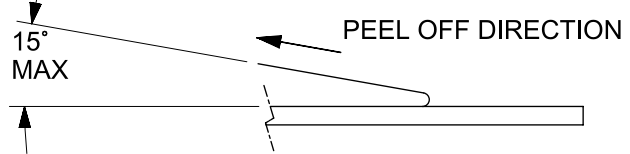

- 3. TAPE & REEL SPECIFICATION IS AS PER EIA-481.
- 4. TAPE & REEL QUANTITY = 500 PCS/REEL
- 5. THE TAPE IS TREATED FOR ANTI-STATIC

THIS DRAWING CONTAINS INFORMATION THAT IS PROPRIETARY TO MOLEX ELECTRONIC TECHNOLOGIES, LLC AND SHOULD NOT BE USED WITHOUT WRITTEN PERMISSION		CURRENT REV DESC:		<b>molex</b>	
DIMENSION UNITS	SCALE	EC NO: 691087			
mm	NTS	DRWN: DANUSA 2022/01/06		CUSTOMER	
GENERAL TOLERANCES (UNLESS SPECIFIED)		CHK'D: DANUSA 2022/01/06		2.00MM PITCH DUAL ROW HDR, SINGLE WAFER, SMT	
		MM	INCH	PRODUCT CUSTOMER DRAWING	
4 PLACES	±			DOCUMENT NUMBER	
3 PLACES	±			SD-87759-277	
2 PLACES	±	0.2		DOC TYPE	DOC PART
1 PLACE	±			PSD	001
0 PLACES	±			REVISION	
				B5	
ANGULAR TOL	±	3.0°		SHEET NUMBER	
DRAFT WHERE APPLICABLE MUST REMAIN WITHIN DIMENSIONS		THIRD ANGLE PROJECTION	DRAWING	SERIES	MATERIAL NUMBER
			A3-SIZE	87759	SEE TABLE
					CUSTOMER
					GENERAL MARKET

WITH CAP IN TAPE & REEL PACKAGING  
 THE 24CKTS SHOWN ABOVE  
 IS FOR ILLUSTRATION ONLY.  
 (THIS TYPE E/TAPE USED FOR CKT 16 TO 50)  
 (PLS REFER TO PK SPEC: PK-89990-484)

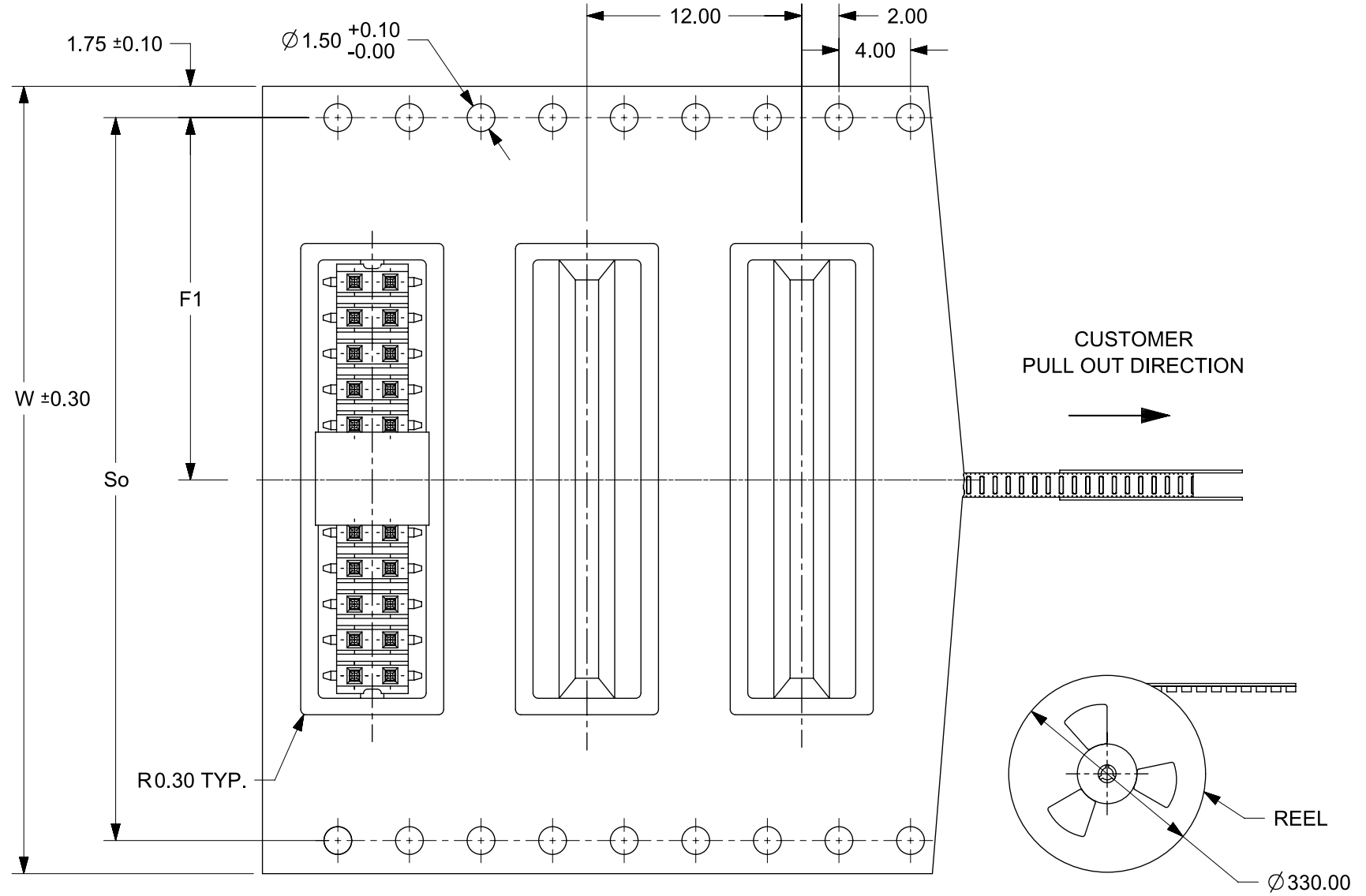
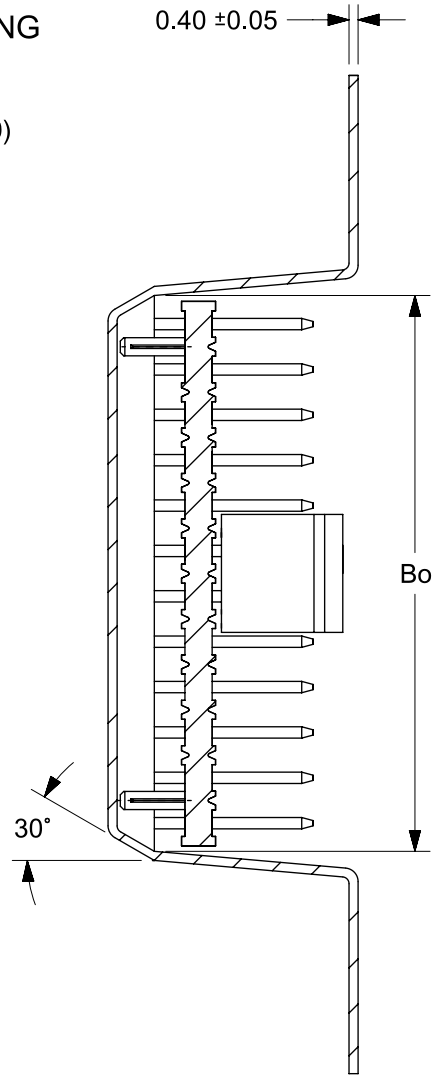

**EMBOSSED CARRIER TAPE TYPE "B"**

- NOTES:  
 1. LEADER AND TRAILER TAPE

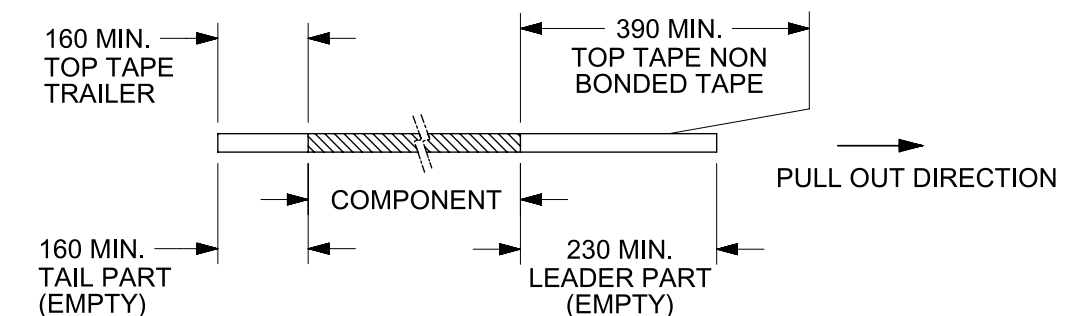



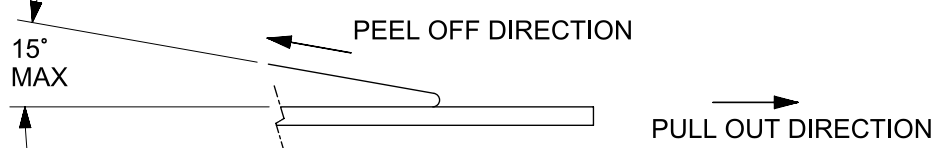



2. PEELING OFF FORCE OF THE TOP TAPE: 20 - 80gf.  
 (PEELING DIRECTION AS SHOWN IN FOLLOWING FIGURE)



3. TAPE & REEL SPECIFICATION IS AS PER EIA-481.  
 4. TAPE & REEL QUANTITY = 500 PCS/REEL  
 5. THE TAPE IS TREATED FOR ANTI-STATIC

THIS DRAWING CONTAINS INFORMATION THAT IS PROPRIETARY TO MOLEX ELECTRONIC TECHNOLOGIES, LLC AND SHOULD NOT BE USED WITHOUT WRITTEN PERMISSION											
DIMENSION UNITS		SCALE		CURRENT REV DESC:							
mm		NTS									
GENERAL TOLERANCES (UNLESS SPECIFIED)				EC NO: 691087		DRWN: DANUSA		2022/01/06		CUSTOMER	
				CHK'D: DANUSA		2022/01/06		2.00MM PITCH DUAL ROW HDR, SINGLE WAFER, SMT			
				APPR: MRAMAKRISHNA		2022/01/06		PRODUCT CUSTOMER DRAWING			
				INITIAL REVISION:		DRWN: SKLIM01		2006/03/23		DOCUMENT NUMBER	
				APPR: PATEY		2006/03/29		SD-87759-277		DOC TYPE DOC PART REVISION	
ANGULAR TOL ± 3.0°				DRAFT WHERE APPLICABLE MUST REMAIN WITHIN DIMENSIONS		THIRD ANGLE PROJECTION		DRAWING		SHEET NUMBER	
						A3-SIZE		87759		4 OF 12	

10	9	8	7	6	5	4	3	2	1										
PART NUMBER WITHOUT CAP IN TRAY	PART NUMBER WITHOUT CAP IN TUBE	PART NUMBER WITH CAP IN TUBE	PART NUMBER WITH CAP IN TAPE & REEL	CKT SIZE	PEG	PLATING TYPE	VOID POSITION	A	B	C	M	(F)	(G)	Bo	F1	So	W	EMBOSSED TYPE	
F	87759-0461	----	----	4	N	1	----	3.90	2.00	---	3.20	5.90	8.10	---	---	---	---	---	
	87759-0462	----	----	4	N	2	----	3.90	2.00	---	3.20	5.90	8.10	---	---	---	---	---	
	87759-0463	----	87759-0493	4	N	3	----	3.90	2.00	---	3.20	5.90	8.10	---	---	---	---	---	
	87759-0661	----	----	6	N	1	----	7.90	6.00	---	3.20	5.90	8.10	---	---	---	---	---	
E	87759-0662	----	----	6	N	2	----	7.90	6.00	---	3.20	5.90	8.10	---	---	---	---	---	
	87759-0663	----	----	6	N	3	----	7.90	6.00	---	3.20	5.90	8.10	---	---	---	---	---	
	----	87759-0861	87759-0871	87759-0881	8	N	1	----	7.90	6.00	---	3.20	5.90	8.10	8.50	11.50	---	24.00	A
	----	87759-0862	87759-0872	87759-0882	8	N	2	----	7.90	6.00	---	3.20	5.90	8.10	8.50	11.50	---	24.00	A
	----	87759-0863	87759-0873	87759-0883	8	N	3	----	7.90	6.00	---	3.20	5.90	8.10	8.50	11.50	---	24.00	A
D	----	87759-6081	87759-7081	87759-8081	8	Y	1	----	7.90	6.00	4.00	3.20	5.90	8.10	8.50	11.50	---	24.00	A
	----	87759-6082	87759-7082	87759-8082	8	Y	2	----	7.90	6.00	4.00	3.20	5.90	8.10	8.50	11.50	---	24.00	A
	----	87759-6083	87759-7083	87759-8083	8	Y	3	----	7.90	6.00	4.00	3.20	5.90	8.10	8.50	11.50	---	24.00	A

10	9	8	7	6	5	4	3	2	1																																																																																																																																														
C																																																																																																																																																							
B																																																																																																																																																							
A																																																																																																																																																							
<table border="1"> <tr> <td colspan="10">THIS DRAWING CONTAINS INFORMATION THAT IS PROPRIETARY TO MOLEX ELECTRONIC TECHNOLOGIES, LLC AND SHOULD NOT BE USED WITHOUT WRITTEN PERMISSION</td> </tr> <tr> <td colspan="2">DIMENSION UNITS</td> <td colspan="2">SCALE</td> <td colspan="6">CURRENT REV DESC:</td> <td colspan="2" rowspan="2">  </td> </tr> <tr> <td colspan="2">mm</td> <td colspan="2">NTS</td> <td colspan="6" rowspan="5">           EC NO: 691087            DRWN: DANUSA 2022/01/06            CHK'D: DANUSA 2022/01/06            APPR: MRAMAKRISHNA 2022/01/06            INITIAL REVISION:            DRWN: SKLIM01 2006/03/23            APPR: PATEY 2006/03/29         </td> <td colspan="2">CUSTOMER DRAWING</td> </tr> <tr> <td colspan="4">GENERAL TOLERANCES (UNLESS SPECIFIED)</td> <td colspan="2">DOCUMENT NUMBER</td> <td colspan="2">DOC TYPE</td> <td colspan="2">DOC PART</td> <td colspan="2">REVISION</td> </tr> <tr> <td colspan="2"></td> <td colspan="2">MM</td> <td colspan="2">INCH</td> <td colspan="2">SD-87759-277</td> <td colspan="2">PSD</td> <td colspan="2">001 B5</td> </tr> <tr> <td colspan="2">4 PLACES</td> <td colspan="2">±</td> <td colspan="2">±</td> <td colspan="2"></td> <td colspan="2"></td> <td colspan="2"></td> </tr> <tr> <td colspan="2">3 PLACES</td> <td colspan="2">±</td> <td colspan="2">±</td> <td colspan="2"></td> <td colspan="2"></td> <td colspan="2"></td> </tr> <tr> <td colspan="2">2 PLACES</td> <td colspan="2">± 0.2</td> <td colspan="2">±</td> <td colspan="2"></td> <td colspan="2"></td> <td colspan="2"></td> </tr> <tr> <td colspan="2">1 PLACE</td> <td colspan="2">±</td> <td colspan="2">±</td> <td colspan="2"></td> <td colspan="2"></td> <td colspan="2"></td> </tr> <tr> <td colspan="2">0 PLACES</td> <td colspan="2">±</td> <td colspan="2">±</td> <td colspan="2"></td> <td colspan="2"></td> <td colspan="2"></td> </tr> <tr> <td colspan="4">ANGULAR TOL ± 3.0°</td> <td colspan="2">THIRD ANGLE PROJECTION</td> <td colspan="2">DRAWING</td> <td colspan="2">SERIES</td> <td colspan="2">SHEET NUMBER</td> </tr> <tr> <td colspan="4">DRAFT WHERE APPLICABLE MUST REMAIN WITHIN DIMENSIONS</td> <td colspan="2">  </td> <td colspan="2">A3-SIZE</td> <td colspan="2">87759</td> <td colspan="2">5 OF 12</td> </tr> </table>										THIS DRAWING CONTAINS INFORMATION THAT IS PROPRIETARY TO MOLEX ELECTRONIC TECHNOLOGIES, LLC AND SHOULD NOT BE USED WITHOUT WRITTEN PERMISSION										DIMENSION UNITS		SCALE		CURRENT REV DESC:								mm		NTS		EC NO: 691087 DRWN: DANUSA 2022/01/06 CHK'D: DANUSA 2022/01/06 APPR: MRAMAKRISHNA 2022/01/06 INITIAL REVISION: DRWN: SKLIM01 2006/03/23 APPR: PATEY 2006/03/29						CUSTOMER DRAWING		GENERAL TOLERANCES (UNLESS SPECIFIED)				DOCUMENT NUMBER		DOC TYPE		DOC PART		REVISION				MM		INCH		SD-87759-277		PSD		001 B5		4 PLACES		±		±								3 PLACES		±		±								2 PLACES		± 0.2		±								1 PLACE		±		±								0 PLACES		±		±								ANGULAR TOL ± 3.0°				THIRD ANGLE PROJECTION		DRAWING		SERIES		SHEET NUMBER		DRAFT WHERE APPLICABLE MUST REMAIN WITHIN DIMENSIONS						A3-SIZE		87759		5 OF 12	
THIS DRAWING CONTAINS INFORMATION THAT IS PROPRIETARY TO MOLEX ELECTRONIC TECHNOLOGIES, LLC AND SHOULD NOT BE USED WITHOUT WRITTEN PERMISSION																																																																																																																																																							
DIMENSION UNITS		SCALE		CURRENT REV DESC:																																																																																																																																																			
mm		NTS		EC NO: 691087 DRWN: DANUSA 2022/01/06 CHK'D: DANUSA 2022/01/06 APPR: MRAMAKRISHNA 2022/01/06 INITIAL REVISION: DRWN: SKLIM01 2006/03/23 APPR: PATEY 2006/03/29								CUSTOMER DRAWING																																																																																																																																											
GENERAL TOLERANCES (UNLESS SPECIFIED)										DOCUMENT NUMBER		DOC TYPE		DOC PART		REVISION																																																																																																																																							
		MM								INCH		SD-87759-277		PSD		001 B5																																																																																																																																							
4 PLACES		±								±																																																																																																																																													
3 PLACES		±								±																																																																																																																																													
2 PLACES		± 0.2		±																																																																																																																																																			
1 PLACE		±		±																																																																																																																																																			
0 PLACES		±		±																																																																																																																																																			
ANGULAR TOL ± 3.0°				THIRD ANGLE PROJECTION		DRAWING		SERIES		SHEET NUMBER																																																																																																																																													
DRAFT WHERE APPLICABLE MUST REMAIN WITHIN DIMENSIONS						A3-SIZE		87759		5 OF 12																																																																																																																																													
<table border="1"> <tr> <td>DOCUMENT STATUS</td> <td>P1</td> <td>RELEASE DATE</td> <td>2022/01/06</td> <td>11:54:31</td> <td colspan="5"></td> </tr> </table>										DOCUMENT STATUS	P1	RELEASE DATE	2022/01/06	11:54:31																																																																																																																																									
DOCUMENT STATUS	P1	RELEASE DATE	2022/01/06	11:54:31																																																																																																																																																			

10		9		8		7		6		5		4		3		2		1		
PART NUMBER WITHOUT CAP IN TUBE	PART NUMBER WITH CAP IN TUBE	PART NUMBER WITH CAP IN TAPE & REEL	PART NUMBER WITHOUT CAP IN TRAY	CKT SIZE	PEG	PLATING TYPE	VOID POSITION	A	B	C	M	(F)	(G)	Bo	F1	So	W	EMBOSSSED TYPE		
F	87759-1061	87759-1071	87759-1081	-----	10	N	1	-----	9.90	8.00	---	3.20	5.90	8.10	10.50	11.50	---	24.00	A	F
	87759-1062	87759-1072	87759-1082	-----	10	N	2	-----	9.90	8.00	---	3.20	5.90	8.10	10.50	11.50	---	24.00	A	F
	87759-1063	87759-1073	87759-1083	-----	10	N	3	-----	9.90	8.00	---	3.20	5.90	8.10	10.50	11.50	---	24.00	A	F
	87759-6101	87759-7101	87759-8101	-----	10	Y	1	-----	9.90	8.00	6.00	3.20	5.90	8.10	10.50	11.50	---	24.00	A	F
	87759-6102	87759-7102	87759-8102	-----	10	Y	2	-----	9.90	8.00	6.00	3.20	5.90	8.10	10.50	11.50	---	24.00	A	F
	87759-6103	87759-7103	87759-8103	-----	10	Y	3	-----	9.90	8.00	6.00	3.20	5.90	8.10	10.50	11.50	---	24.00	A	F
E	87759-1070	87759-7030	87759-7010	-----	10	Y	1	----	9.90	8.00	6.00	3.60	6.50	8.70	10.50	11.50	---	24.00	A	E
																				E
	87759-1261	87759-1271	87759-1281	-----	12	N	1	-----	11.90	10.00	---	3.20	5.90	8.10	12.50	11.50	---	24.00	A	E
	87759-1262	87759-1272	87759-1282	-----	12	N	2	-----	11.90	10.00	---	3.20	5.90	8.10	12.50	11.50	---	24.00	A	E
	87759-1263	87759-1273	87759-1283	-----	12	N	3	-----	11.90	10.00	---	3.20	5.90	8.10	12.50	11.50	---	24.00	A	E
	87759-6121	87759-7121	87759-8121	-----	12	Y	1	-----	11.90	10.00	---	3.20	5.90	8.10	12.50	11.50	---	24.00	A	E
	87759-6122	87759-7122	87759-8122	-----	12	Y	2	-----	11.90	10.00	---	3.20	5.90	8.10	12.50	11.50	---	24.00	A	E
D	87759-6123	87759-7123	87759-8123	-----	12	Y	3	-----	11.90	10.00	---	3.20	5.90	8.10	12.50	11.50	---	24.00	A	D
	----	-----	----	87759-0005	12	N	4	----	11.90	10.00	---	4.57	7.57	---	---	---	---	---	---	D
																				D
	87759-1461	87759-1471	87759-1481	-----	14	N	1	-----	13.90	12.00	---	3.20	5.90	8.10	14.50	11.50	---	24.00	A	D
	87759-1462	87759-1472	87759-1482	-----	14	N	2	-----	13.90	12.00	---	3.20	5.90	8.10	14.50	11.50	---	24.00	A	D
	87759-1463	87759-1473	87759-1483	-----	14	N	3	-----	13.90	12.00	---	3.20	5.90	8.10	14.50	11.50	---	24.00	A	D
C	87759-6141	87759-7141	87759-8141	-----	14	Y	1	-----	13.90	12.00	---	3.20	5.90	8.10	14.50	11.50	---	24.00	A	C
	87759-6142	87759-7142	87759-8142	-----	14	Y	2	-----	13.90	12.00	---	3.20	5.90	8.10	14.50	11.50	---	24.00	A	C
	87759-6143	87759-7143	87759-8143	-----	14	Y	3	-----	13.90	12.00	---	3.20	5.90	8.10	14.50	11.50	---	24.00	A	C
	----	-----	87759-0003	-----	14	Y	1	-----	13.90	12.00	---	4.00	6.70	8.05	14.20	11.50	---	24.00	A	C
	87759-1470	87759-7032	87759-7012	-----	14	Y	1	----	13.90	12.00	6.00	3.60	6.50	8.70	14.50	11.50	---	24.00	A	C

B																			
A																			

THIS DRAWING CONTAINS INFORMATION THAT IS PROPRIETARY TO MOLEX ELECTRONIC TECHNOLOGIES, LLC AND SHOULD NOT BE USED WITHOUT WRITTEN PERMISSION																					
DIMENSION UNITS		SCALE		CURRENT REV DESC:																	
mm		NTS		<div style="text-align: center;"> <p><b>CUSTOM HEADER</b> 2.00MM PITCH DUAL ROW HDR, SINGLE WAFER, SMT</p> <p>PRODUCT CUSTOMER DRAWING</p> </div>																	
GENERAL TOLERANCES (UNLESS SPECIFIED)																					
		MM																		INCH	
4 PLACES		±																		±	
3 PLACES		±																		±	
2 PLACES		± 0.2		±																	
1 PLACE		±		±																	
0 PLACES		±		±																	
ANGULAR TOL ± 3.0°				EC NO: 691087 DRWN: DANUSA 2022/01/06 CHK'D: DANUSA 2022/01/06 APPR: MRAMAKRISHNA 2022/01/06 INITIAL REVISION: DRWN: SKLIM01 2006/03/23 APPR: PATEY 2006/03/29																	
DRAFT WHERE APPLICABLE MUST REMAIN WITHIN DIMENSIONS				THIRD ANGLE PROJECTION		DRAWING		SERIES		MATERIAL NUMBER		CUSTOMER		DOCUMENT NUMBER		DOC TYPE		DOC PART		REVISION	
						A3-SIZE		87759		SEE TABLE		GENERAL MARKET		SD-87759-277		PSD		001		B5	
DOCUMENT STATUS				P1		RELEASE DATE		2022/01/06		11:54:31											

10	9	8	7	6	5	4	3	2	1									
PART NUMBER WITHOUT CAP IN TUBE	PART NUMBER WITH CAP IN TUBE	PART NUMBER WITH CAP IN TAPE & REEL	CKT SIZE	PEG	PLATING TYPE	VOID POSITION	A	B	C	M	(F)	(G)	Bo	F1	So	W	EMBOSSED TYPE	
F	87759-1661	87759-1671	87759-1681	16	N	1	----	15.90	14.00	---	3.20	5.90	8.10	16.50	14.20	28.40	32.00	B
	87759-1662	87759-1672	87759-1682	16	N	2	----	15.90	14.00	---	3.20	5.90	8.10	16.50	14.20	28.40	32.00	B
	87759-1663	87759-1673	87759-1683	16	N	3	----	15.90	14.00	---	3.20	5.90	8.10	16.50	14.20	28.40	32.00	B
	87759-6161	87759-7161	87759-8161	16	Y	1	----	15.90	14.00	---	3.20	5.90	8.10	16.50	14.20	28.40	32.00	B
	87759-6162	87759-7162	87759-8162	16	Y	2	----	15.90	14.00	---	3.20	5.90	8.10	16.50	14.20	28.40	32.00	B
	87759-6163	87759-7163	87759-8163	16	Y	3	----	15.90	14.00	---	3.20	5.90	8.10	16.50	14.20	28.40	32.00	B
E	87759-1611	87759-1612	87759-1613	16	N	4	----	15.90	14.00	---	5.50	8.20	9.60	16.50	14.20	28.40	32.00	B
	87759-1670	87759-7033	87759-7013	16	Y	1	----	15.90	14.00	12.20	3.60	6.50	8.70	16.50	16.50	28.40	28.40	B
	87759-6737	877596707	87759-1667	16	Y	1	----	15.90	14.00	12.00	6.80	9.50	10.83	16.40	14.20	28.40	32.00	B
	87759-1861	87759-1871	87759-1881	18	N	1	----	17.90	16.00	---	3.20	5.90	8.10	18.50	14.20	28.40	32.00	B
	87759-1862	87759-1872	87759-1882	18	N	2	----	17.90	16.00	---	3.20	5.90	8.10	18.50	14.20	28.40	32.00	B
	87759-1863	87759-1873	87759-1883	18	N	3	----	17.90	16.00	---	3.20	5.90	8.10	18.50	14.20	28.40	32.00	B
D	87759-6181	87759-7181	87759-8181	18	Y	1	----	17.90	16.00	---	3.20	5.90	8.10	18.50	14.20	28.40	32.00	B
	87759-6182	87759-7182	87759-8182	18	Y	2	----	17.90	16.00	---	3.20	5.90	8.10	18.50	14.20	28.40	32.00	B
	87759-6183	87759-7183	87759-8183	18	Y	3	----	17.90	16.00	---	3.20	5.90	8.10	18.50	14.20	28.40	32.00	B
	----	87759-0002	87759-0001	18	Y	1	----	17.90	16.00	14.00	10.30	13.00	14.31	18.40	20.20	40.40	44.00	B
		87759-1820	87759-1820	18	N	4	---	17.90	16.00	---	8.40	11.10	12.47	18.40	20.20	40.40	44.00	B
C	87759-2061	87759-2071	87759-2081	20	N	1	----	19.90	18.00	---	3.20	5.90	8.10	20.50	20.20	40.40	44.00	B
	87759-2062	87759-2072	87759-2082	20	N	2	----	19.90	18.00	---	3.20	5.90	8.10	20.50	20.20	40.40	44.00	B
	87759-2063	87759-2073	87759-2083	20	N	3	----	19.90	18.00	---	3.20	5.90	8.10	20.50	20.20	40.40	44.00	B
	87759-6201	87759-7201	87759-8201	20	Y	1	----	19.90	18.00	---	3.20	5.90	8.10	20.50	20.20	40.40	44.00	B
	87759-6202	87759-7202	87759-8202	20	Y	2	----	19.90	18.00	---	3.20	5.90	8.10	20.50	20.20	40.40	44.00	B

<p>THIS DRAWING CONTAINS INFORMATION THAT IS PROPRIETARY TO MOLEX ELECTRONIC TECHNOLOGIES, LLC AND SHOULD NOT BE USED WITHOUT WRITTEN PERMISSION</p>										DIMENSION UNITS <b>mm</b>		SCALE <b>NTS</b>		CURRENT REV DESC:										
										GENERAL TOLERANCES (UNLESS SPECIFIED)														
												MM		INCH		EC NO: 691087 DRWN: DANUSA 2022/01/06 CHK'D: DANUSA 2022/01/06 APPR: MRAMAKRISHNA 2022/01/06 INITIAL REVISION: DRWN: SKLIM01 2006/03/23 APPR: PATEY 2006/03/29				DOCUMENT NUMBER		DOC TYPE	DOC PART	REVISION
										4 PLACES		±		±						SD-87759-277		PSD	001	B5
										3 PLACES		±		±										
										2 PLACES		± 0.2		±										
										1 PLACE		±		±										
										0 PLACES		±		±										
										ANGULAR TOL		± 3.0°												
										DRAFT WHERE APPLICABLE MUST REMAIN WITHIN DIMENSIONS				THIRD ANGLE PROJECTION		DRAWING		SERIES		MATERIAL NUMBER		CUSTOMER		SHEET NUMBER
						A3-SIZE		87759		SEE TABLE		GENERAL MARKET		7 OF 12										

10	9	8	7	6	5	4	3	2	1									
PART NUMBER WITHOUT CAP IN TUBE	PART NUMBER WITH CAP IN TUBE	PART NUMBER WITH CAP IN TAPE & REEL	CKT SIZE	PEG	PLATING TYPE	VOID POSITION	A	B	C	M	(F)	(G)	Bo	F1	So	W	EMBOSSED TYPE	
F	87759-6203	87759-7203	87759-8203	20	Y	3	-----	19.90	18.00	---	3.20	5.90	8.10	20.50	20.20	40.40	44.00	B
	-----	87759-8053	87759-8054	20	N	2	-----	19.90	18.00	----	3.80	6.50	8.70	20.20	14.20	28.40	32.00	B
	-----	87759-0019	87759-0020	20	Y	1	-----	19.90	18.00	16.00	3.20	5.90	8.05	20.50	20.20	40.40	44.00	B
	87759-5801	87759-5802	87759-2058	20	Y	1	-----	19.90	18.00	16.00	4.30	7.00	8.31	20.50	14.20	28.40	32.00	B
	87759-2261	87759-2271	87759-2281	22	N	1	-----	21.90	20.00	---	3.20	5.90	8.10	22.50	20.20	40.40	44.00	B
E	87759-2262	87759-2272	87759-2282	22	N	2	-----	21.90	20.00	---	3.20	5.90	8.10	22.50	20.20	40.40	44.00	B
	87759-2263	87759-2273	87759-2283	22	N	3	-----	21.90	20.00	---	3.20	5.90	8.10	22.50	20.20	40.40	44.00	B
	87759-6221	87759-7221	87759-8221	22	Y	1	-----	21.90	20.00	---	3.20	5.90	8.10	22.50	20.20	40.40	44.00	B
	87759-6222	87759-7222	87759-8222	22	Y	2	-----	21.90	20.00	---	3.20	5.90	8.10	22.50	20.20	40.40	44.00	B
	87759-6223	87759-7223	87759-8223	22	Y	3	-----	21.90	20.00	---	3.20	5.90	8.10	22.50	20.20	40.40	44.00	B
	87759-2461	87759-2471	87759-2481	24	N	1	-----	23.90	22.00	---	3.20	5.90	8.10	24.50	20.20	40.40	44.00	B
D	87759-2462	87759-2472	87759-2482	24	N	2	-----	23.90	22.00	---	3.20	5.90	8.10	24.50	20.20	40.40	44.00	B
	87759-2463	87759-2473	87759-2483	24	N	3	-----	23.90	22.00	---	3.20	5.90	8.10	24.50	20.20	40.40	44.00	B
	87759-6241	87759-7241	87759-8241	24	Y	1	-----	23.90	22.00	---	3.20	5.90	8.10	24.50	20.20	40.40	44.00	B
	87759-6242	87759-7242	87759-8242	24	Y	2	-----	23.90	22.00	---	3.20	5.90	8.10	24.50	20.20	40.40	44.00	B
	87759-6243	87759-7243	87759-8243	24	Y	3	-----	23.90	22.00	---	3.20	5.90	8.10	24.50	20.20	40.40	44.00	B
	87759-2661	87759-2671	87759-2681	26	N	1	-----	25.90	24.00	---	3.20	5.90	8.10	26.50	20.20	40.40	44.00	B
C	87759-2662	87759-2672	87759-2682	26	N	2	-----	25.90	24.00	---	3.20	5.90	8.10	26.50	20.20	40.40	44.00	B
	87759-2663	87759-2673	87759-2683	26	N	3	-----	25.90	24.00	---	3.20	5.90	8.10	26.50	20.20	40.40	44.00	B
	87759-6261	87759-7261	87759-8261	26	Y	1	-----	25.90	24.00	---	3.20	5.90	8.10	26.50	20.20	40.40	44.00	B
	87759-6262	87759-7262	87759-8262	26	Y	2	-----	25.90	24.00	---	3.20	5.90	8.10	26.50	20.20	40.40	44.00	B
	87759-6263	87759-7263	87759-8263	26	Y	3	-----	25.90	24.00	---	3.20	5.90	8.10	26.50	20.20	40.40	44.00	B

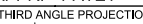
THIS DRAWING CONTAINS INFORMATION THAT IS PROPRIETARY TO MOLEX ELECTRONIC TECHNOLOGIES, LLC AND SHOULD NOT BE USED WITHOUT WRITTEN PERMISSION											
DIMENSION UNITS		SCALE		CURRENT REV DESC:				 CUSTOM HEADER 2.00MM PITCH DUAL ROW HDR, SINGLE WAFER, SMT			
mm		NTS									
GENERAL TOLERANCES (UNLESS SPECIFIED)				EC NO: 691087				2022/01/06			
				DRWN: DANUSA				2022/01/06			
				CHK'D: DANUSA				2022/01/06			
				APPR: MRAMAKRISHNA				2022/01/06			
				INITIAL REVISION:							
				DRWN: SKLIM01				2006/03/23			
				APPR: PATEY				2006/03/29			
ANGULAR TOL ± 3.0°				THIRD ANGLE PROJECTION				DRAWING			
				SERIES				MATERIAL NUMBER			
				A3-SIZE				CUSTOMER			
				87759				SHEET NUMBER			
				SEE TABLE				8 OF 12			
				GENERAL MARKET							



10	9	8	7	6	5	4	3	2	1									
PART NUMBER WITHOUT CAP IN TUBE	PART NUMBER WITH CAP IN TUBE	PART NUMBER WITH CAP IN TAPE & REEL	CKT SIZE	PEG	PLATING TYPE	VOID POSITION	A	B	C	M	(F)	(G)	Bo	F1	So	W	EMBOSSED TYPE	
F	87759-2861	87759-2871	87759-2881	28	N	1	-----	27.90	26.00	---	3.20	5.90	8.10	28.50	20.20	40.40	44.00	B
	87759-2862	87759-2872	87759-2882	28	N	2	-----	27.90	26.00	---	3.20	5.90	8.10	28.50	20.20	40.40	44.00	B
	87759-2863	87759-2873	87759-2883	28	N	3	-----	27.90	26.00	---	3.20	5.90	8.10	28.50	20.20	40.40	44.00	B
	87759-6281	87759-7281	87759-8281	28	Y	1	-----	27.90	26.00	---	3.20	5.90	8.10	28.50	20.20	40.40	44.00	B
	87759-6282	87759-7282	87759-8282	28	Y	2	-----	27.90	26.00	---	3.20	5.90	8.10	28.50	20.20	40.40	44.00	B
	87759-6283	87759-7283	87759-8283	28	Y	3	-----	27.90	26.00	---	3.20	5.90	8.10	28.50	20.20	40.40	44.00	B
E																		
	87759-3061	87759-3071	87759-3081	30	N	1	-----	29.90	28.00	---	3.20	5.90	8.10	30.50	20.20	40.40	44.00	B
	87759-3062	87759-3072	87759-3082	30	N	2	-----	29.90	28.00	---	3.20	5.90	8.10	30.50	20.20	40.40	44.00	B
	87759-3063	87759-3073	87759-3083	30	N	3	-----	29.90	28.00	---	3.20	5.90	8.10	30.50	20.20	40.40	44.00	B
	87759-6301	87759-7301	87759-8301	30	Y	1	-----	29.90	28.00	---	3.20	5.90	8.10	30.50	20.20	40.40	44.00	B
	87759-6302	87759-7302	87759-8302	30	Y	2	-----	29.90	28.00	---	3.20	5.90	8.10	30.50	20.20	40.40	44.00	B
	87759-6303	87759-7303	87759-8303	30	Y	3	-----	29.90	28.00	---	3.20	5.90	8.10	30.50	20.20	40.40	44.00	B
D																		
	87759-3261	87759-3271	87759-3281	32	N	1	-----	31.90	30.00	---	3.20	5.90	8.10	32.50	26.20	52.40	56.00	B
	87759-3262	87759-3272	87759-3282	32	N	2	-----	31.90	30.00	---	3.20	5.90	8.10	32.50	26.20	52.40	56.00	B
	87759-3263	87759-3273	87759-3283	32	N	3	-----	31.90	30.00	---	3.20	5.90	8.10	32.50	26.20	52.40	56.00	B
	87759-6321	87759-7321	87759-8321	32	Y	1	-----	31.90	30.00	---	3.20	5.90	8.10	32.50	26.20	52.40	56.00	B
	87759-6322	87759-7322	87759-8322	32	Y	2	-----	31.90	30.00	---	3.20	5.90	8.10	32.50	26.20	52.40	56.00	B
C	87759-6323	87759-7323	87759-8323	32	Y	3	-----	31.90	30.00	---	3.20	5.90	8.10	32.50	26.20	52.40	56.00	B
	87759-0009	-----	-----	32	Y	1	-----	31.90	30.00	28.00	8.00	10.70	---	----	----	----	---	---
	87759-0010	-----	-----	32	N	1	-----	31.90	30.00	28.00	8.00	10.70	---	----	----	----	---	---

<p>THIS DRAWING CONTAINS INFORMATION THAT IS PROPRIETARY TO MOLEX ELECTRONIC TECHNOLOGIES, LLC AND SHOULD NOT BE USED WITHOUT WRITTEN PERMISSION</p>										DIMENSION UNITS <b>mm</b>		SCALE <b>NTS</b>		CURRENT REV DESC:											
										GENERAL TOLERANCES (UNLESS SPECIFIED)												EC NO: 691087		DRWN: DANUSA 2022/01/06	
										4 PLACES ±		±		CHK'D: DANUSA 2022/01/06		APPR: MRAMAKRISHNA 2022/01/06		PRODUCT CUSTOMER DRAWING							
										3 PLACES ±		±		INITIAL REVISION:				DOCUMENT NUMBER		DOC TYPE		DOC PART		REVISION	
										2 PLACES ±		0.2 ±		DRWN: SKLIM01 2006/03/23				SD-87759-277		PSD		001		B5	
										1 PLACE ±		±		APPR: PATEY 2006/03/29				MATERIAL NUMBER		CUSTOMER		SHEET NUMBER			
										0 PLACES ±		±		ANGULAR TOL ± 3.0°				SEE TABLE		GENERAL MARKET		9 OF 12			
										DRAFT WHERE APPLICABLE MUST REMAIN WITHIN DIMENSIONS				THIRD ANGLE PROJECTION		DRAWING		SERIES		A3-SIZE		87759			
										DOCUMENT STATUS		P1		RELEASE DATE		2022/01/06 11:54:31									

10	9	8	7	6	5	4	3	2	1									
PART NUMBER WITHOUT CAP IN TUBE	PART NUMBER WITH CAP IN TUBE	PART NUMBER WITH CAP IN TAPE & REEL	CKT SIZE	PEG	PLATING TYPE	VOID POSITION	A	B	C	M	(F)	(G)	Bo	F1	So	W	EMBOSSED TYPE	
F	87759-3461	87759-3471	87759-3481	34	N	1	----	33.90	32.00	---	3.20	5.90	8.10	34.50	26.20	52.40	56.00	B
	87759-3462	87759-3472	87759-3482	34	N	2	----	33.90	32.00	---	3.20	5.90	8.10	34.50	26.20	52.40	56.00	B
	87759-3463	87759-3473	87759-3483	34	N	3	----	33.90	32.00	---	3.20	5.90	8.10	34.50	26.20	52.40	56.00	B
	87759-6341	87759-7341	87759-8341	34	Y	1	----	33.90	32.00	---	3.20	5.90	8.10	34.50	26.20	52.40	56.00	B
	87759-6342	87759-7342	87759-8342	34	Y	2	----	33.90	32.00	---	3.20	5.90	8.10	34.50	26.20	52.40	56.00	B
	87759-6343	87759-7343	87759-8343	34	Y	3	----	33.90	32.00	---	3.20	5.90	8.10	34.50	26.20	52.40	56.00	B
E																		
	87759-3661	87759-3671	87759-3681	36	N	1	----	35.90	34.00	---	3.20	5.90	8.10	36.50	26.20	52.40	56.00	B
	87759-3662	87759-3672	87759-3682	36	N	2	----	35.90	34.00	---	3.20	5.90	8.10	36.50	26.20	52.40	56.00	B
	87759-3663	87759-3673	87759-3683	36	N	3	----	35.90	34.00	---	3.20	5.90	8.10	36.50	26.20	52.40	56.00	B
	87759-6361	87759-7361	87759-8361	36	Y	1	----	35.90	34.00	---	3.20	5.90	8.10	36.50	26.20	52.40	56.00	B
	87759-6362	87759-7362	87759-8362	36	Y	2	----	35.90	34.00	---	3.20	5.90	8.10	36.50	26.20	52.40	56.00	B
D	87759-6363	87759-7363	87759-8363	36	Y	3	----	35.90	34.00	---	3.20	5.90	8.10	36.50	26.20	52.40	56.00	B
	87759-0014	----	----	36	N	1	----	35.90	34.00	---	9.50	12.20	---	---	---	---	---	---
	87759-3861	87759-3871	87759-3881	38	N	1	----	37.90	36.00	---	3.20	5.90	8.10	38.50	26.20	52.40	56.00	B
	87759-3862	87759-3872	87759-3882	38	N	2	----	37.90	36.00	---	3.20	5.90	8.10	38.50	26.20	52.40	56.00	B
	87759-3863	87759-3873	87759-3883	38	N	3	----	37.90	36.00	---	3.20	5.90	8.10	38.50	26.20	52.40	56.00	B
C	87759-6381	87759-7381	87759-8381	38	Y	1	----	37.90	36.00	---	3.20	5.90	8.10	38.50	26.20	52.40	56.00	B
	87759-6382	87759-7382	87759-8382	38	Y	2	----	37.90	36.00	---	3.20	5.90	8.10	38.50	26.20	52.40	56.00	B
	87759-6383	87759-7383	87759-8383	38	Y	3	----	37.90	36.00	---	3.20	5.90	8.10	38.50	26.20	52.40	56.00	B

<p style="text-align: center;">THIS DRAWING CONTAINS INFORMATION THAT IS PROPRIETARY TO MOLEX ELECTRONIC TECHNOLOGIES, LLC AND SHOULD NOT BE USED WITHOUT WRITTEN PERMISSION</p>										DIMENSION UNITS <b>mm</b>		SCALE <b>NTS</b>		CURRENT REV DESC:														
										GENERAL TOLERANCES (UNLESS SPECIFIED)												EC NO: 691087 DRWN: DANUSA CHK'D: DANUSA APPR: MRAMAKRISHNA		2022/01/06 2022/01/06 2022/01/06				
										4 PLACES		±		±		INITIAL REVISION: DRWN: SKLIM01 APPR: PATEY				DOCUMENT NUMBER <b>SD-87759-277</b>		DOC TYPE <b>PSD</b>	DOC PART <b>001</b>	REVISION <b>B5</b>				
										3 PLACES		±		±						2006/03/23 2006/03/29		MATERIAL NUMBER SEE TABLE	CUSTOMER GENERAL MARKET		SHEET NUMBER 10 OF 12			
										2 PLACES		±		0.2 ±						DRAFT WHERE APPLICABLE MUST REMAIN WITHIN DIMENSIONS		THIRD ANGLE PROJECTION 	DRAWING <b>A3-SIZE</b>	SERIES <b>87759</b>				
										1 PLACE		±		±														
										0 PLACES		±		±														
										ANGULAR TOL		±		3.0°														
										DOCUMENT STATUS   P1   RELEASE DATE   2022/01/06 11:54:31																		



10	9	8	7	6	5	4	3	2	1									
PART NUMBER WITHOUT CAP IN TUBE	PART NUMBER WITH CAP IN TUBE	PART NUMBER WITH CAP IN TAPE & REEL	CKT SIZE	PEG	PLATING TYPE	VOID POSITION	A	B	C	M	(F)	(G)	Bo	F1	So	W	EMBOSSSED TYPE	
F	87759-4661	87759-4671	87759-4681	46	N	1	----	45.90	44.00	---	3.20	5.90	8.10	46.50	34.20	68.40	72.00	B
	87759-4662	87759-4672	87759-4682	46	N	2	----	45.90	44.00	---	3.20	5.90	8.10	46.50	34.20	68.40	72.00	B
	87759-4663	87759-4673	87759-4683	46	N	3	----	45.90	44.00	---	3.20	5.90	8.10	46.50	34.20	68.40	72.00	B
	87759-6461	87759-7461	87759-8461	46	Y	1	----	45.90	44.00	---	3.20	5.90	8.10	46.50	34.20	68.40	72.00	B
	87759-6462	87759-7462	87759-8462	46	Y	2	----	45.90	44.00	---	3.20	5.90	8.10	46.50	34.20	68.40	72.00	B
E	87759-6463	87759-7463	87759-8463	46	Y	3	----	45.90	44.00	---	3.20	5.90	8.10	46.50	34.20	68.40	72.00	B
	87759-4861	87759-4871	87759-4881	48	N	1	----	47.90	46.00	---	3.20	5.90	8.10	48.50	34.20	68.40	72.00	B
	87759-4862	87759-4872	87759-4882	48	N	2	----	47.90	46.00	---	3.20	5.90	8.10	48.50	34.20	68.40	72.00	B
	87759-4863	87759-4873	87759-4883	48	N	3	----	47.90	46.00	---	3.20	5.90	8.10	48.50	34.20	68.40	72.00	B
	87759-6481	87759-7481	87759-8481	48	Y	1	----	47.90	46.00	---	3.20	5.90	8.10	48.50	34.20	68.40	72.00	B
D	87759-6482	87759-7482	87759-8482	48	Y	2	----	47.90	46.00	---	3.20	5.90	8.10	48.50	34.20	68.40	72.00	B
	87759-6483	87759-7483	87759-8483	48	Y	3	----	47.90	46.00	---	3.20	5.90	8.10	48.50	34.20	68.40	72.00	B
	87759-5061	87759-5071	87759-5081	50	N	1	----	49.90	48.00	---	3.20	5.90	8.10	50.50	34.20	68.40	72.00	B
	87759-5062	87759-5072	87759-5082	50	N	2	----	49.90	48.00	---	3.20	5.90	8.10	50.50	34.20	68.40	72.00	B
	87759-5063	87759-5073	87759-5083	50	N	3	----	49.90	48.00	---	3.20	5.90	8.10	50.50	34.20	68.40	72.00	B
C	87759-6501	87759-7501	87759-8501	50	Y	1	----	49.90	48.00	---	3.20	5.90	8.10	50.50	34.20	68.40	72.00	B
	87759-6502	87759-7502	87759-8502	50	Y	2	----	49.90	48.00	---	3.20	5.90	8.10	50.50	34.20	68.40	72.00	B
	87759-6503	87759-7503	87759-8503	50	Y	3	----	49.90	48.00	---	3.20	5.90	8.10	50.50	34.20	68.40	72.00	B

THIS DRAWING CONTAINS INFORMATION THAT IS PROPRIETARY TO MOLEX ELECTRONIC TECHNOLOGIES, LLC AND SHOULD NOT BE USED WITHOUT WRITTEN PERMISSION																					
DIMENSION UNITS		SCALE		CURRENT REV DESC:						 <b>CUSTOM HEADER</b> 2.00MM PITCH DUAL ROW HDR, SINGLE WAFER, SMT											
mm		NTS																			
GENERAL TOLERANCES (UNLESS SPECIFIED)				MM		INCH		EC NO: 691087		2022/01/06		DOCUMENT NUMBER		DOC TYPE		DOC PART		REVISION			
4 PLACES		±		±		±		DRWN: DANUSA		2022/01/06											
3 PLACES		±		±		±		CHK'D: DANUSA		2022/01/06		<b>PRODUCT CUSTOMER DRAWING</b> SD-87759-277    PSD    001    B5									
2 PLACES		±		0.2		±		APPR: MRAMAKRISHNA		2022/01/06											
1 PLACE		±		±		±		INITIAL REVISION:		2006/03/23		MATERIAL NUMBER						CUSTOMER		SHEET NUMBER	
0 PLACES		±		±		±		DRWN: SKLIM01		2006/03/29											
ANGULAR TOL				±		3.0°		DRAFT WHERE APPLICABLE MUST REMAIN WITHIN DIMENSIONS		THIRD ANGLE PROJECTION		DRAWING		SERIES		SEE TABLE		GENERAL MARKET		12 OF 12	
A3-SIZE		87759																			