

Data Sheet IVQ-3005

Version 1.3 - 28.07.2020

PRODUCT FAMILY

K-Band VCO Transceiver with advanced MMIC technology and angle of arrival measurement capability

APPLICATIONS

- Traffic Monitoring
- Industrial Applications

- Movement
- Velocity
- Direction
- Presence
- Distance
- Angle

FEATURES:

- » K-Band VCO Transceiver with advanced SiGe MMIC technology
- » supports CW / FSK / FMCW modes
- » two receiving antennas for phase comparison operation
- » integrated RF - pre-amplifier for long range applications
- » I/Q channels for direction of motion discrimination
- » integrated programmable IF - amplifier

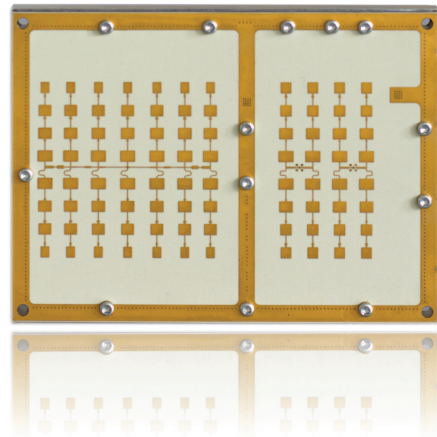

DESCRIPTION

The IVQ-3005 provides an advanced 24GHz MMIC Design. The module can be used in CW / FSK / FMCW-mode.

The two receiving antennas provide the feature to measure the angle of arrival in a defined area.

CERTIFICATES

InnoSenT GmbH has established and applies a quality system for: development, production and sales of radar sensors for industrial and automotive sensors. More information on our quality standards:

<https://www.innosent.de/en/company/certifications/>

ADDITIONAL INFORMATION

InnoSenT Standard Product. Changes will not be notified as long as there is no influence on form, fit and within this data sheet specified function of the product.

RoHS-INFO

This product is compliant to the restriction of hazardous substances (RoHS - European Union directive 2011/65/EU).

CONFIDENTIAL AND PROPRIETARY

The information contained in this document shall remain the sole and exclusive property of InnoSenT GmbH and shall not be disclosed by the recipient to third parties without prior consent of InnoSenT in writing.

ELECTRICAL CHARACTERISTICS

PARAMETER	CONDITIONS	SYMBOL	MIN	TYP	MAX	UNITS
Transmitter						
transmit frequency ¹		f	24 - 24.250			GHz
output power (EIRP) ¹	EIRP adjustable	P _{out}	8		30	dBm
phase noise	@1kHz (PLL locked)			-63		dBc/Hz
attenuator voltage input	lookup table available		0		3.3	V
Receiver²						
noise figure	@100KHz SSB			11	17	dB
quadrature phase imbalance				1	10	deg
quadrature amplitude imbalance				1	3	dB
max. IF-gain				62		dB
programmable LF- gain range			34		62	dB
IF lower cutoff frequency			25	30	35	Hz
IF upper cutoff frequency	depends on Gain-setting		55		61	kHz
DC-Offset			1.35	1.5	1.65	V
Antenna						
TX antenna gain			17.5		19	dBi
TX side lobe suppression			20	30		dB
RX antenna gain			14.5		16	dBi
RX side lobe suppression			20	25		dB
system side lobe suppression			35	40		dB
non ambiguous range	see phase characteristics on page 5		±20			deg
system antenna pattern (10dB)		azimuth	±12	±15		deg
		elevation	±7	±10		deg
Power supply						
supply voltage		V _{CC}	5.5	5.8	6.1	V
permissible ripple voltage					1	mVpp
supply current Vcc		I _{CC}		410	450	mA
Environment						
operating temperature		T _{OP}	-25		+60	°C
storage temperature		T _{storage}	-25		+60	°C

¹must be adjusted by customer to limitations

²make sure that the expected beat frequency is within the bandwidth of the IF amplifier

CONFIDENTIAL AND PROPRIETARY

The information contained in this document shall remain the sole and exclusive property of InnoSenT GmbH and shall not be disclosed by the recipient to third parties without prior consent of InnoSenT in writing.

PARAMETER	CONDITIONS	SYMBOL	MIN	TYP	MAX	UNITS
PLL						
PLL type	ADF4158		fractional-n			
settling time				10		μs
PLL-Loop BW	@2.5mA CP currant / CP-Setting "7"				130	kHz
crystal oscillator						
frequency		$f_{\text{crystal oscillator}}$		30		MHz
crystal oscillator	temp. Drift				50	ppm
Mechanical Outlines						
outline dimensions	compare to schematic on page 7	height length width		8(13) 117,6 87,6		mm

BANDWIDTH AND GAIN SIMULATION

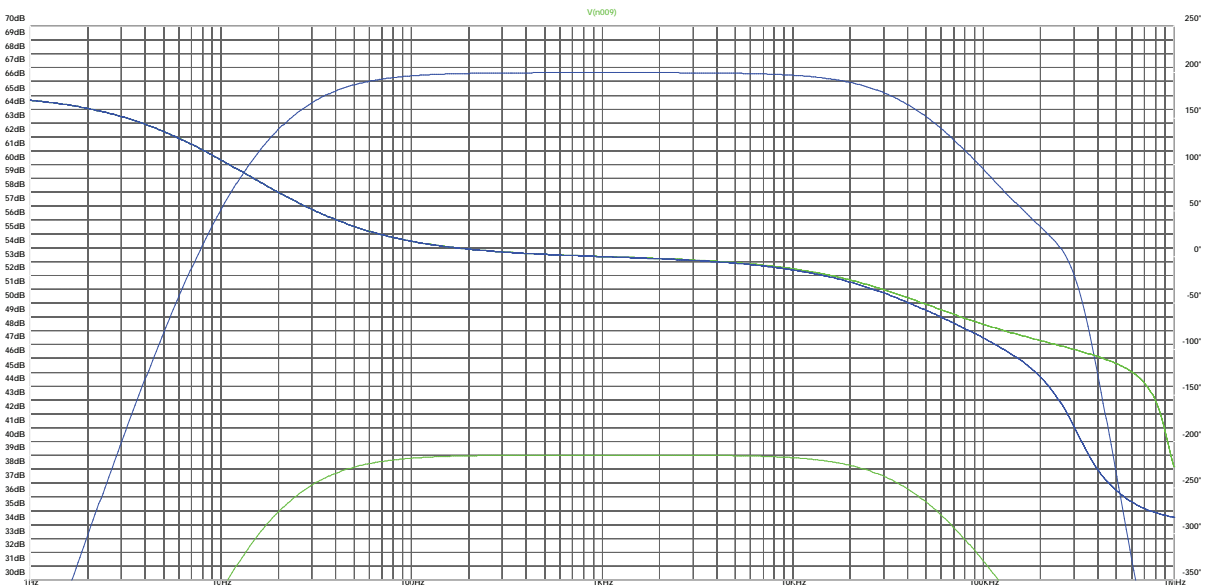

CONFIDENTIAL AND PROPRIETARY

The information contained in this document shall remain the sole and exclusive property of InnoSenT GmbH and shall not be disclosed by the recipient to third parties without prior consent of InnoSenT in writing.

BLOCK DIAGRAMM

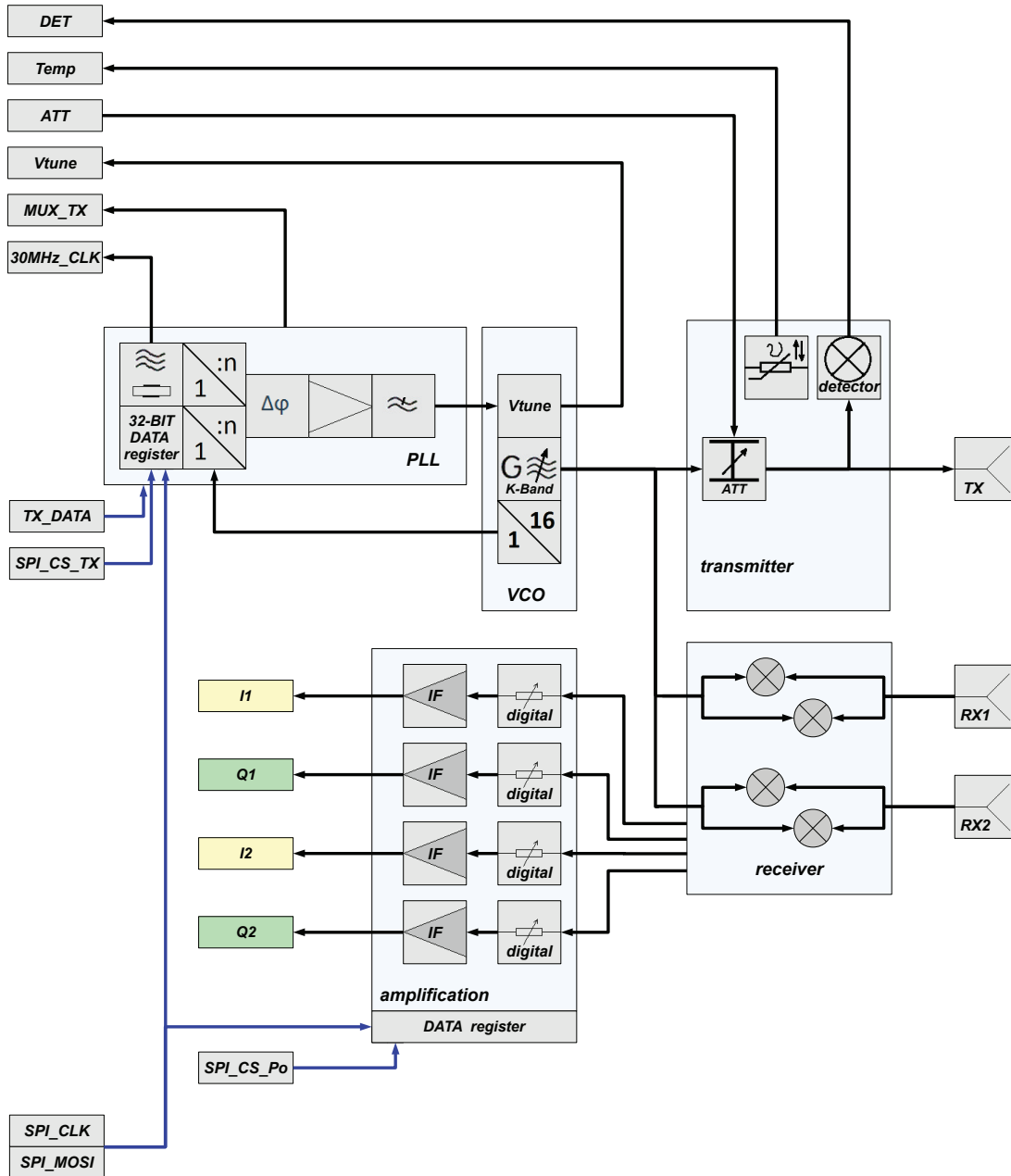

CONFIDENTIAL AND PROPRIETARY

The information contained in this document shall remain the sole and exclusive property of InnoSenT GmbH and shall not be disclosed by the recipient to third parties without prior consent of InnoSenT in writing.

SYSTEM PATTERN

Antenna Orientation:

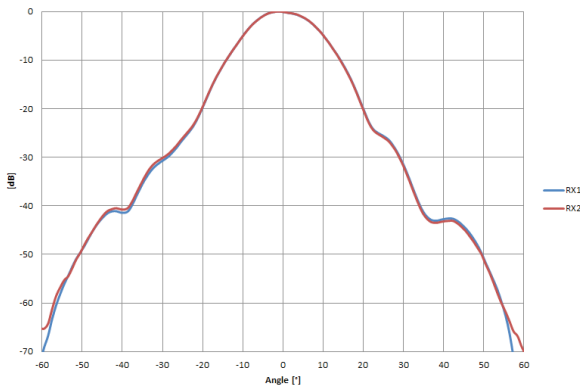
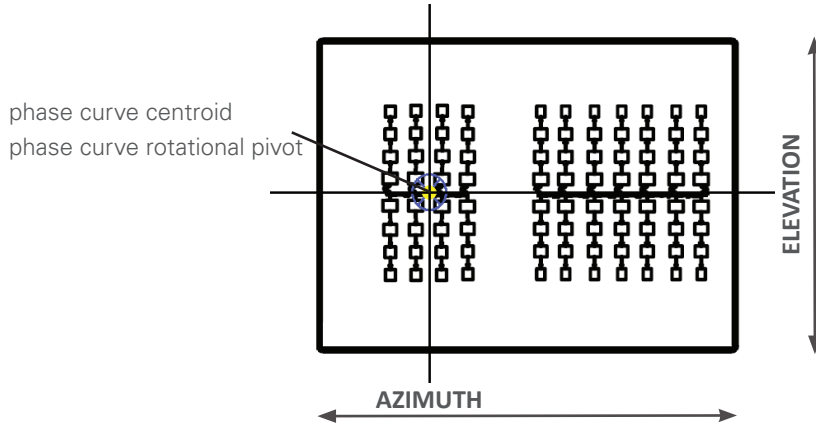

IVQ-3005 system-pattern (AZIMUTH)

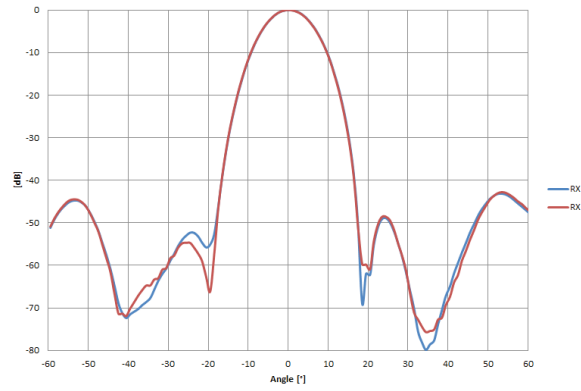

IVQ-3005 system-pattern (ELEVATION)

PHASE CHARACTERISTICS

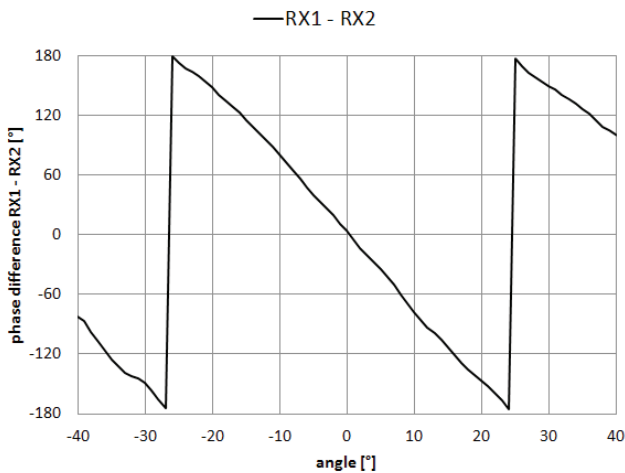

CONFIDENTIAL AND PROPRIETARY

The information contained in this document shall remain the sole and exclusive property of InnoSenT GmbH and shall not be disclosed by the recipient to third parties without prior consent of InnoSenT in writing.

INTERFACE - ANALOG CONNECTOR

The sensor provides a IRISO Connector Type IMSA-9855B-22Y914

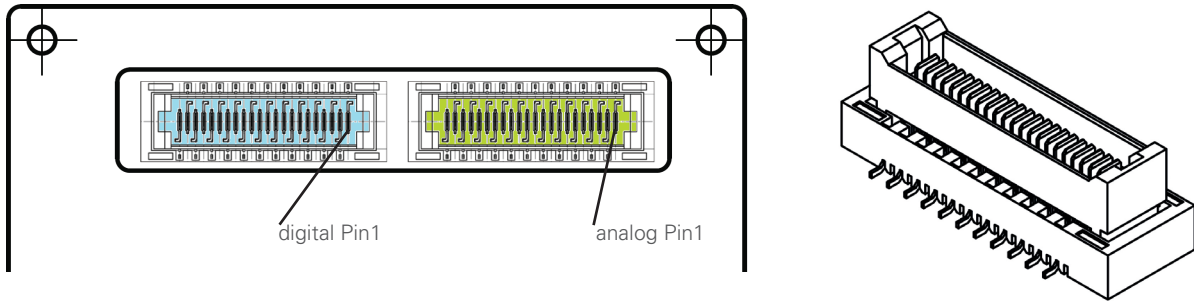

PIN #	DESCRIPTION	MIN	TYP	MAX		COMMENT
1	N.C.					not connected
2	Vcc	5.5	5.8	6.1	V	pos. power supply
3	GND	0		0	V	GND
4	N.C.					not connected
5	GND	0		0	V	GND
6	Q1	0		3.3	V	IF-output Q1 (Rx0 antenna)
7	GND	0		0	V	GND
8	I1	0		3.3	V	IF-output I1 (Rx0 antenna)
9	GND	0		0	V	GND
10	I2	0		3.3	V	IF-output I2 (Rx1 antenna)
11	GND	0		0	V	GND
12	Q2	0		3.3	V	IF-output Q2 (Rx1 antenna)
13	GND	0		0	V	GND
14	ATT	0		3.3	V	control-voltage for output power attenuator
15	GND	0		0	V	GND
16	Temp	0		3.3	V	output LM20CIM (TI) temperature sensor
17	GND	0		0	V	GND
18	DET	0		3.3	V	output power detector
19	GND	0		0	V	GND
20	N.C.					not connected
21	Vtune	0		5.0	V	VCO tuning-voltage output
22	N.C.					not connected

CONFIDENTIAL AND PROPRIETARY

The information contained in this document shall remain the sole and exclusive property of InnoSenT GmbH and shall not be disclosed by the recipient to third parties without prior consent of InnoSenT in writing.

INTERFACE - DIGITAL CONNECTOR

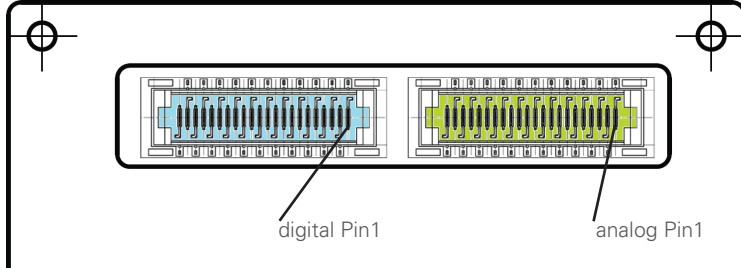

PIN #	DESCRIPTION	MIN	TYP	MAX		COMMENT
1	N.C.					not connected
2	N.C.					not connected
3	N.C.					not connected
4	VCO_EN	0V		Vcc		VCO enable >2V: ON, <0.4V: OFF
5	GND	0		0	V	GND
6	N.C.					not connected
7	N.C.	0		3.3	V	not connected
8	MUX_TX	0		3.3	V	MUX-output PLL ADF4158
9	GND	0		0	V	GND
10	N.C.					not connected
11	SPI_CS_TX	0		3.3	V	SPI_CS input of PLL
12	SPI_CS_POTI	0		3.3	V	SPI_CS input of prog. gain potentiometer
13	GND	0		0	V	GND
14	SPI_MOSI	0		3.3	V	SPI input MOSI
15	GND	0		0	V	GND
16	SPI_CLK	0		3.3	V	SPI CLK input
17	GND	0		0	V	GND
18	TX_DATA	0		3.3	V	PLL modulation trigger input
19	GND	0		0	V	GND
20	30MHZ_CLK	0		3.3	V	30MHZ reference clk output
21	GND	0		0	V	GND
22	GND	0		0	V	OUT-GND for module detection

CONFIDENTIAL AND PROPRIETARY



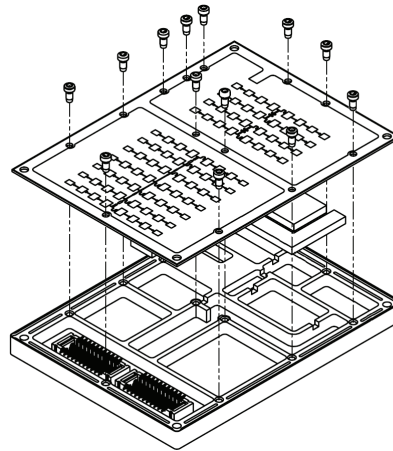

The information contained in this document shall remain the sole and exclusive property of InnoSenT GmbH and shall not be disclosed by the recipient to third parties without prior consent of InnoSenT in writing.

MECHANICAL OUTLINES

isometry view



top view

-  Rx1 antenna centroid
Rx1 rotational pivot
-  Rx2 antenna centroid
Rx2 rotational pivot
-  phase curve centroid
phase curve rotational pivot
-  system centroid
system rotational pivot

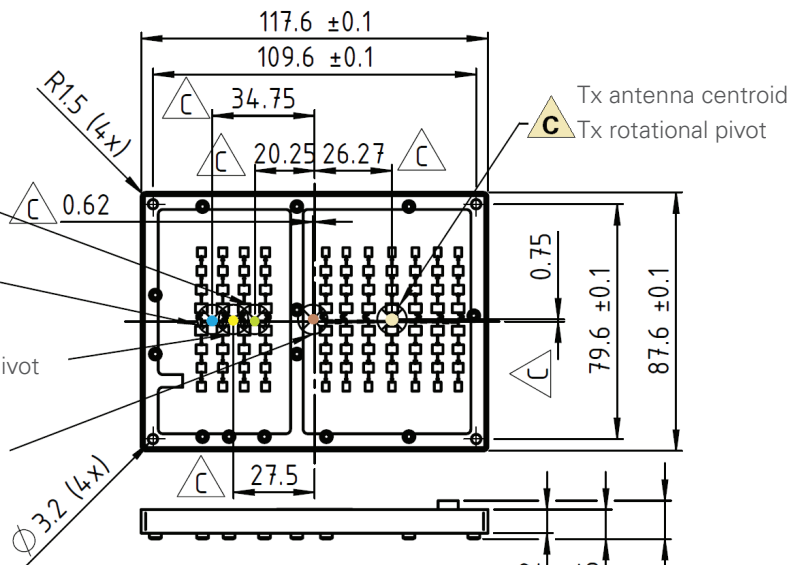

bottom view

Etiketteninhalt:

DataMatrix-Code
IVQ-3005
S/N 8-stellig
InnoSenT

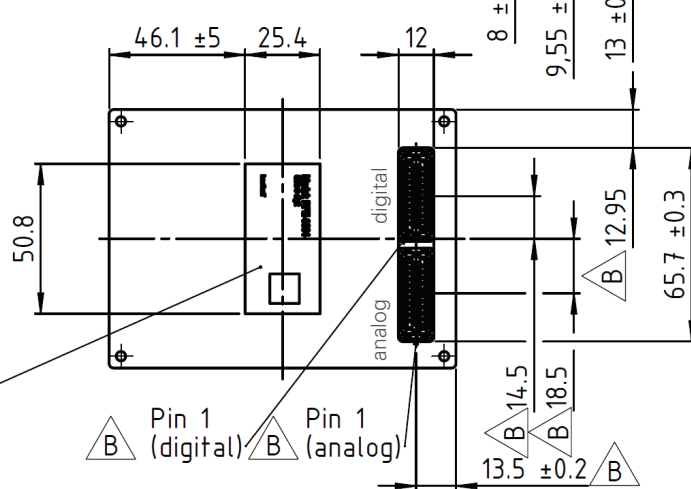

CONFIDENTIAL AND PROPRIETARY

The information contained in this document shall remain the sole and exclusive property of InnoSenT GmbH and shall not be disclosed by the recipient to third parties without prior consent of InnoSenT in writing.

TAKE CARE



Programming the PLL with inadequate values can lead to TX-Frequencies that can violate legal limits!



Inadequate signals on Vmod_in may lead to TX-Frequencies that can violate legal limits!



If the attenuator voltage is not set correctly, TX-Power can violate legal limits!

ESD-INFORMATION



This InnoSenT sensor is sensitive to damage from ESD. Normal precautions as usually applied to CMOS devices are sufficient when handling the device. Touching the signal output pins has to be avoided at any time before soldering or plugging the device into a motherboard.

APPROVAL

This Data Sheet contains the technical specifications of the described product. All previous versions of this Data Sheet are no longer valid.

The sensor uses Hydrocarbon based material which may change its dielectric properties when used in an oxidative environment. This may vary based on temperature. Therefore InnoSenT recommends evaluating this influence within the specific environment.

VERSION	DATE	COMMENT
1.0	17.06.2016	initial release
1.1	14.11.2017	small changes in block diagram
1.2	22.02.2018	small changes in PLL-Setting
1.3	28.07.2020	new layout

InnoSenT GmbH

Am Rödertor 30
97499 Donnersdorf
GERMANY

Tel.: +49 (0) 9528 - 9518 - 0
E-Mail: info@innosent.de
URL: www.innosent.de