



Sales Outline Drawing

Specifications:

Sound Level Category	Loud	
Mode of Operation	Continuous	
Voltage Rating	20 to 28 VAC/DC	
Frequency	3900 ± 500 Hz	
Loudness @ 1M	80 to 85 dB(A) Typ.	
Sound Current Draw	25mA MAX	
Stack Level	BOTTOM	TOP
LED Color	YELLOW	RED
LED Current Draw	60mA MAX	60mA MAX
Total Max Current Draw	145mA MAX	
Housing Material	6/6 Nylon, Color: Black	
Top Cap / Lens Material	6/6 Nylon, Color: Opaque White	
Storage Temperature	-40° to +70° C	
Operating Temperature	-30° to +60° C	
Mounting	Recommended hole size is 22.5 mm.	
Knurled Nut	The max recommended torque is 10 in-lbs.	
Cable	Gray, UL Style 21894, 300V, 105°C, 24AWG, Pb-Free Tinned Leads	
Weight (Typical)	35 grams	
NEMA 12	Approved with use of included gasket.	
Options	Please contact factory.	

Dimensions: Inches (mm) **cUL Recognized** **ROHS Compliant**

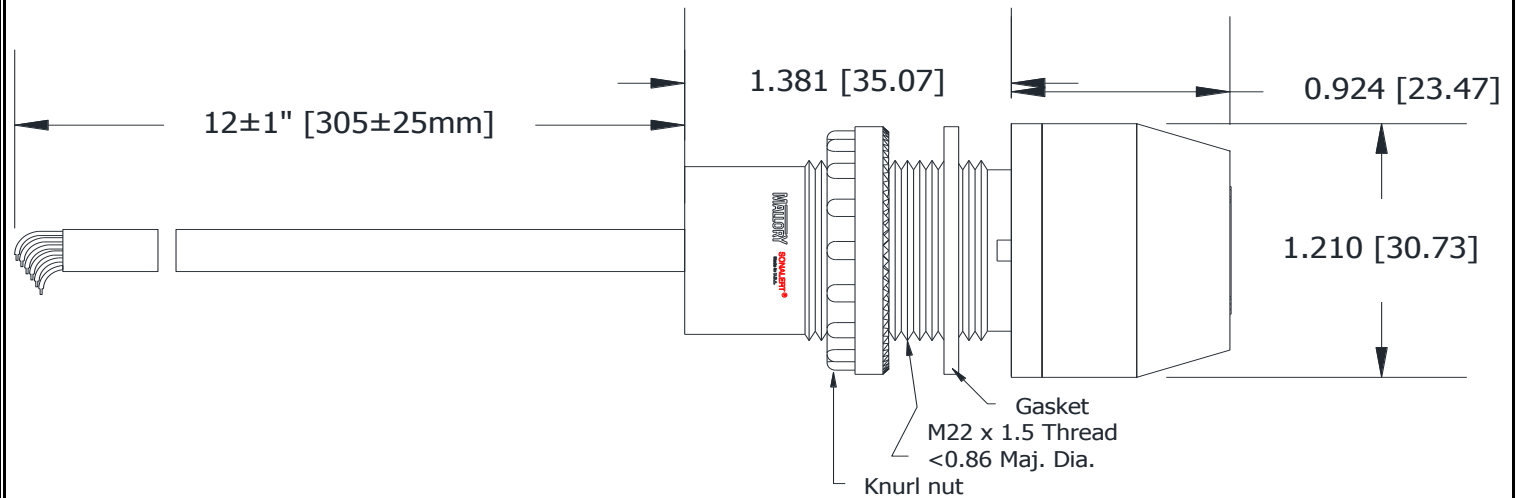

Connections:

- SOUND BLACK wire and ORANGE wire to Power
- BOTTOM BROWN wire and YELLOW wire to Power
- TOP BROWN wire and RED wire to Power