

REVISIONS			
REV	DESCRIPTION	DATE	BY

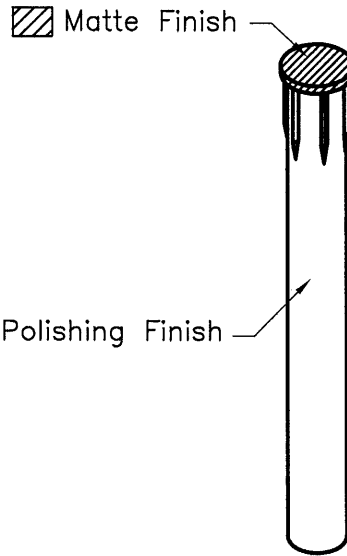

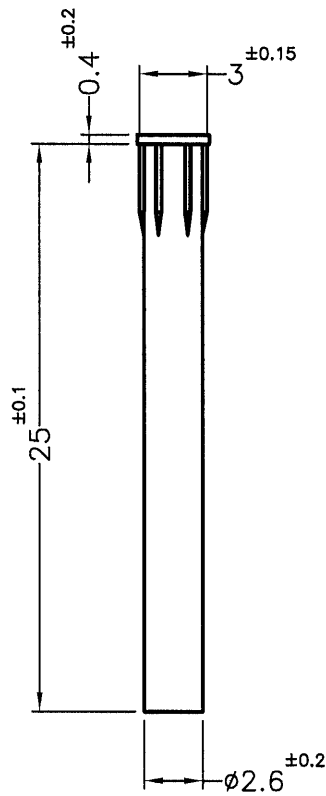

NOTE:MADE OF EQUIVALENT MATERIAL.  
均可使用同等材質.

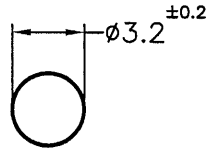
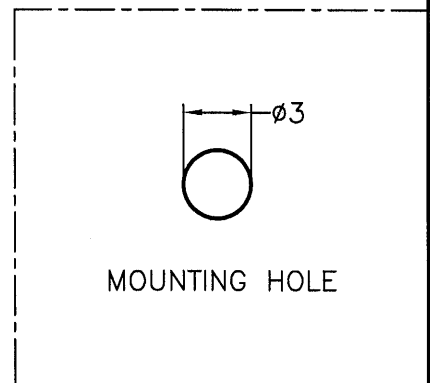

MOUNTING HOLE

DELTA P/N:3252658300

 <p>康揚企業股份有限公司 KANG YANG HARDWARE ENTERPRISE CO., LTD. 康揚塑膠(東莞)有限公司 KANG YANG PLASTIC(DONG GUAN) CO., LTD. 康哲電腦配件(吳江)有限公司 KANG CHE COMPUTER COMPONENTS(WUJIANG) CO., LTD.</p>	TITLE		LIGHT PIPE		SPEC. DWG.		
	MATERIAL		PC UL94V-0		DATE		2014.10.03
	FINISH		SEE ABOVE		DRAWN		LUKE
	COLOR		NATURAL(CLEAR)		CHECK		
PART NUMBER	DRAWING NUMBER		UNLESS OTHERWISE SPECIFIED TOLERANCE		APPROVED		
LEM-189V0	LEM-189		SEE ABOVE				
SIZE	SCALE	UNIT	REV				
A4	3:1	mm	A				